

# My Book of

# EASY CRAFTS



*If your child can use scissors and glue fairly well,  
then this book will build on that foundation.*

Use this book to help your child practice cutting, folding,  
and pasting to improve fine motor skills.

## My Book of

# EASY CRAFTS

### The aims and purpose of this book

▲ This workbook was designed especially for children who will make three-dimensional objects for the first time. Simple contours and large tabs for pasting make it easy for children to successfully complete the assignment. The paper objects can also be used as toys afterwards. Children will have fun wearing, decorating, or playing with the toy they have made. Using scissors and glue will help develop children's fine motor skills and enhance their brain functions.

▲ Turning two-dimensional parts into three-dimensional objects will give your child a satisfying experience in creating things. As they finish making the crafts one by one, children will grow more confident in what they can do with their hands. If your child has difficulty while making objects, you can offer to help. The time you spend together creating crafts will definitely become a precious experience for your child.

### How to use this book

▲ Please choose the right size and weight safety scissors fitted to your child's hand.

▲ The line ——— on the left side of this book should be cut by parents, so please cut it either with scissors or a paper cutter, and give it to your child before he or she starts to cut out the project on the page.

▲ The line ■■■■■ in the text of this book is the cutting line. It is not a problem if your child is not able to cut along the line exactly. Your child will gradually become able to cut accurately and well.

▲ There are two kinds of folding lines in the text of this book. Please tell your child about the following folding lines and if your child has difficulty folding the lines, please help by demonstrating for him or her.

Fold downwards along ■■■■■ .      Fold upwards along ■■■■■ .



▲ If your child has difficulty folding, trace over the folding lines with a dry ballpoint pen or any tool that comes to a point.

▲ The number given to each piece is in accordance with the order in which it should be used.

▲ Use glue sparingly. Please wait until the glue dries before allowing your child to play with the paper objects.

▲ Most workbooks contain the same paper stock, but each Kumon Workbook features a different type of paper, tailored to a specific activity and use. This book features good, strong quality paper to help your child cut more easily.



### How to hold scissors properly



Let your child put the thumb into the smaller hole and the forefinger and middle finger into the bigger hole on the scissors (if it is more stable for your child to put the ring finger as well into the bigger hole, please allow him or her to do so).

Check the way that your child is holding the scissors to judge whether or not the scissors and his or her hand are straight.



Please help your child arrange the pieces before gluing. Have your child place a small amount of glue on all glue marks, and then help attach pieces according to the specific directions on each page.

\*In the diagrams included in the instructions, the pink-shaded side ■ indicates the front side of a piece and the gray-shaded side ■ indicates the back.

# 1

## Wristwatch

### To parents

If your child has difficulty folding, trace over the folding lines with a dry ballpoint pen or any tool that comes to a point. The number given to each piece is in accordance with the order in which it should be used. In the diagrams included in the instructions, the pink-shaded side indicates the front side of a piece and the gray-shaded side indicates the back.

1. Cut along the thick lines .

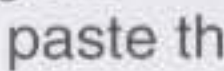
2. Fold **1** downwards along the dotted lines  and paste the edges.

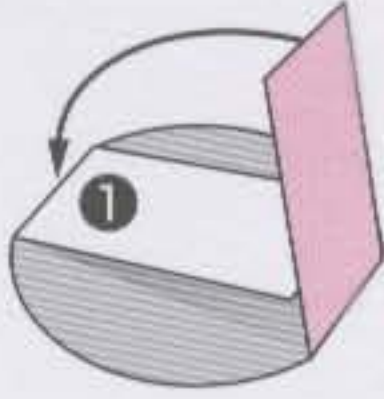

3. Put **2** through the loop underneath **1**. Adjust the band's length according to your wrist size.

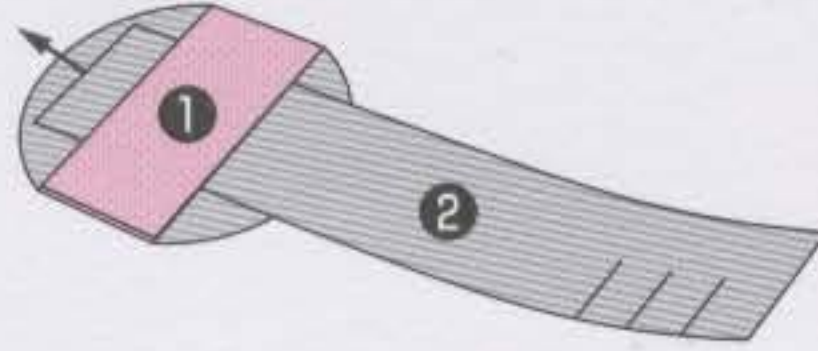

Wear it around your wrist.

HOW TO PLAY



2

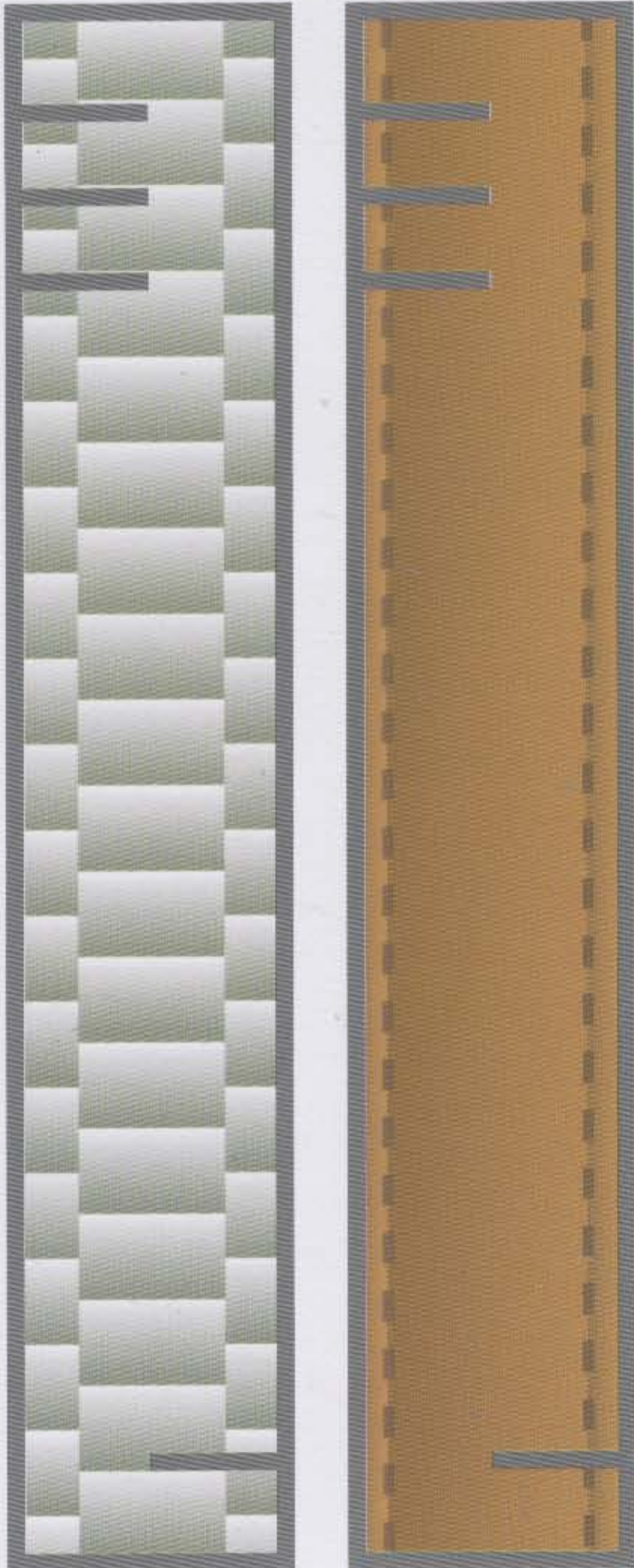

1



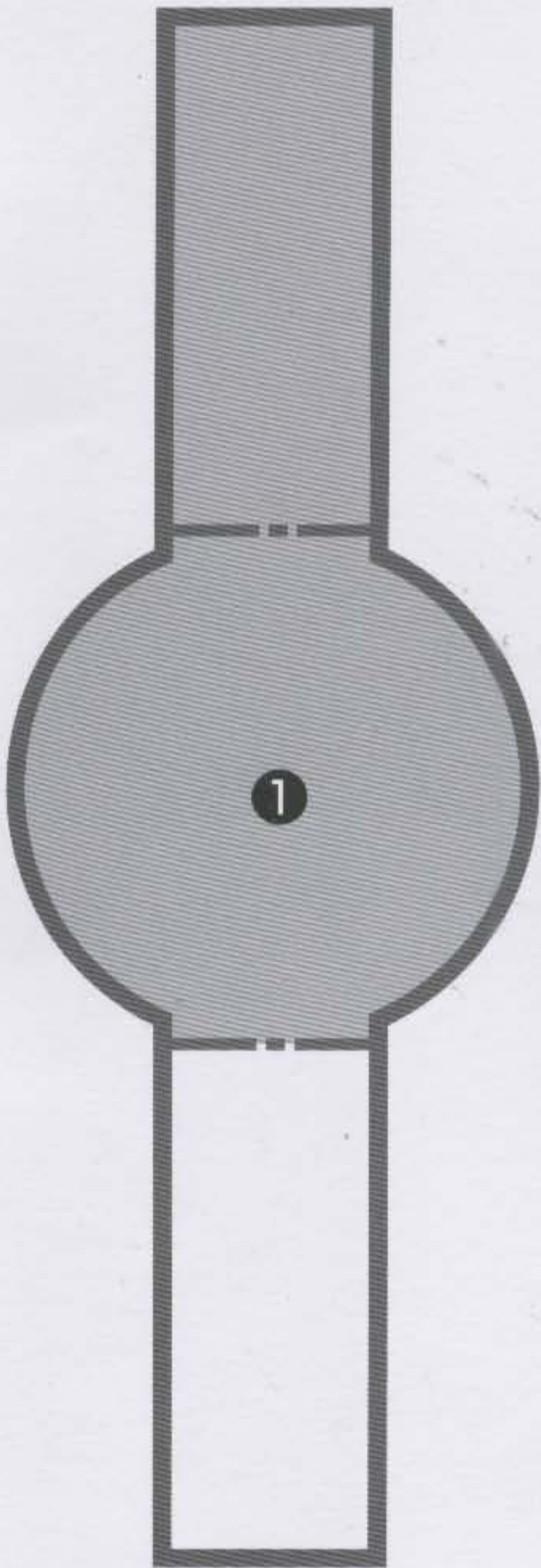

1

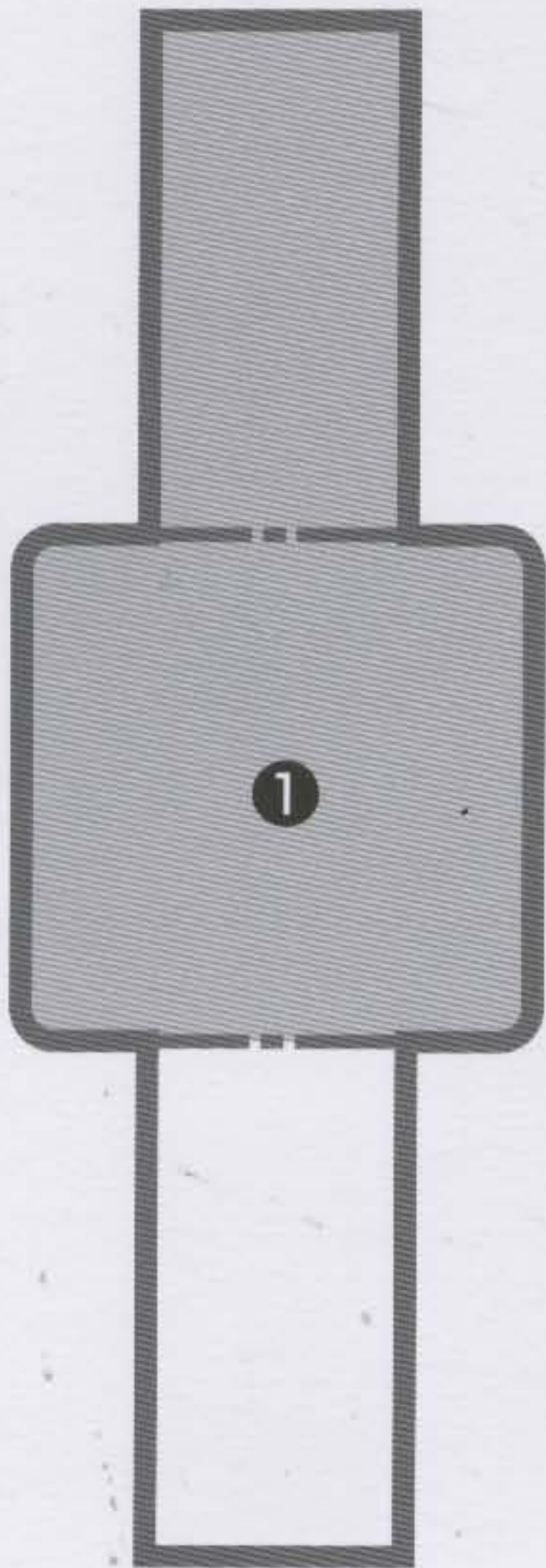

1



2



2

# 2

## Ring

1. Cut along the thick lines .

2. Adjust the length of each of the pieces of ① according to your finger size and paste the ends together.

3. Paste a piece ② onto each of the loops made in step 2.

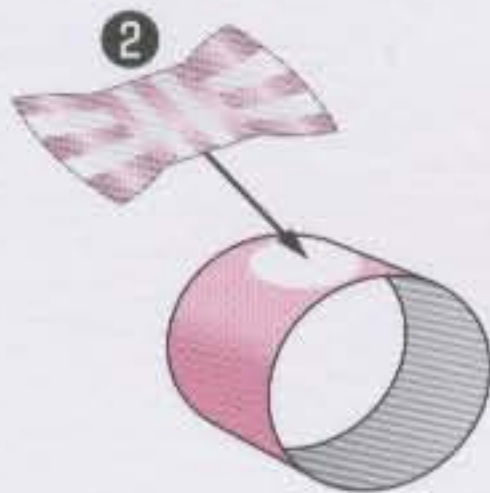
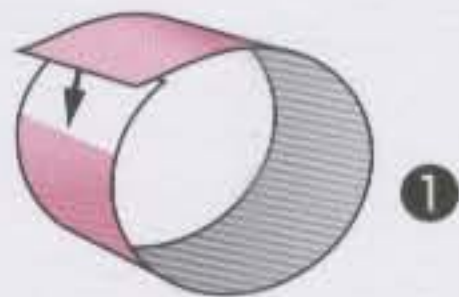

HOW TO PLAY

Wear it around your finger.

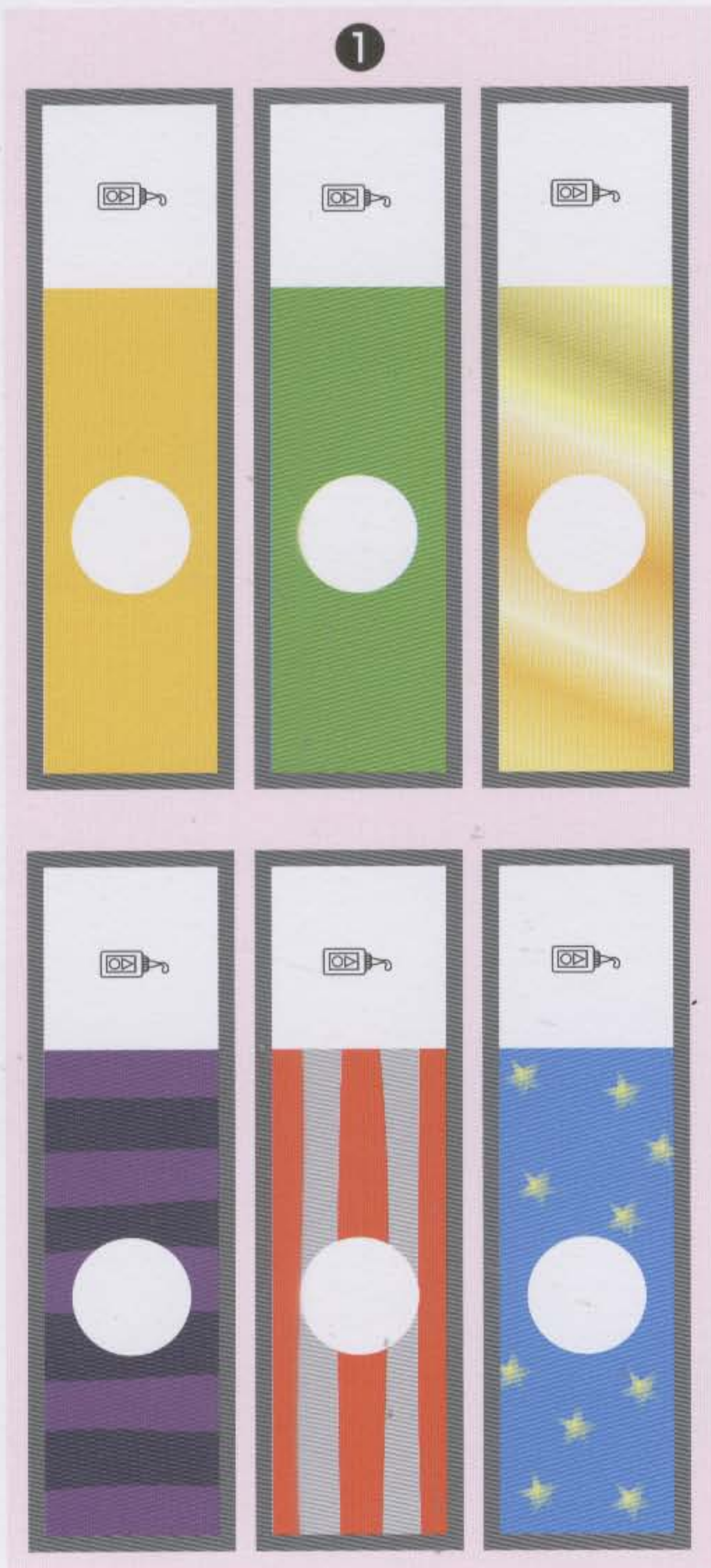

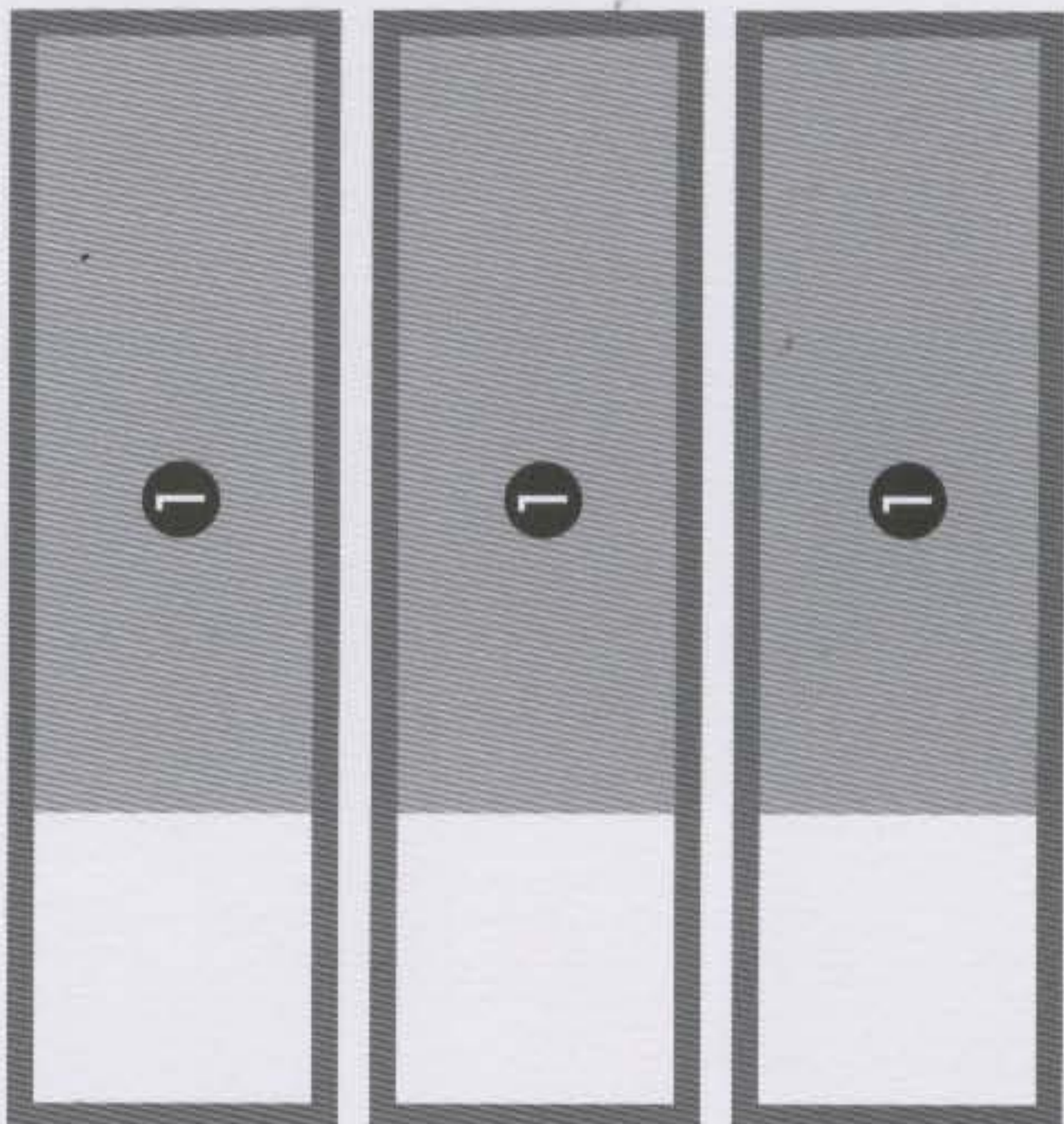
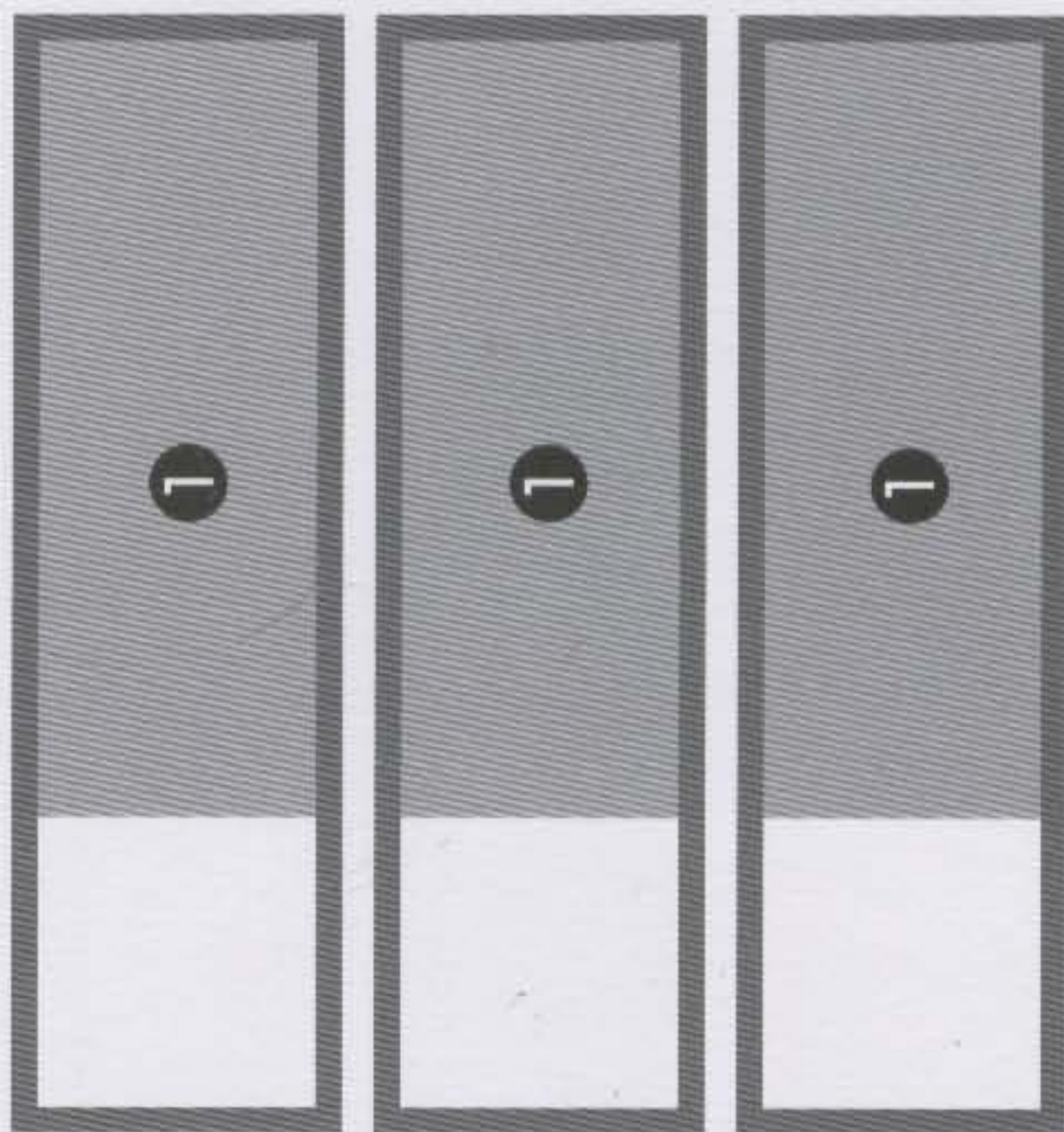
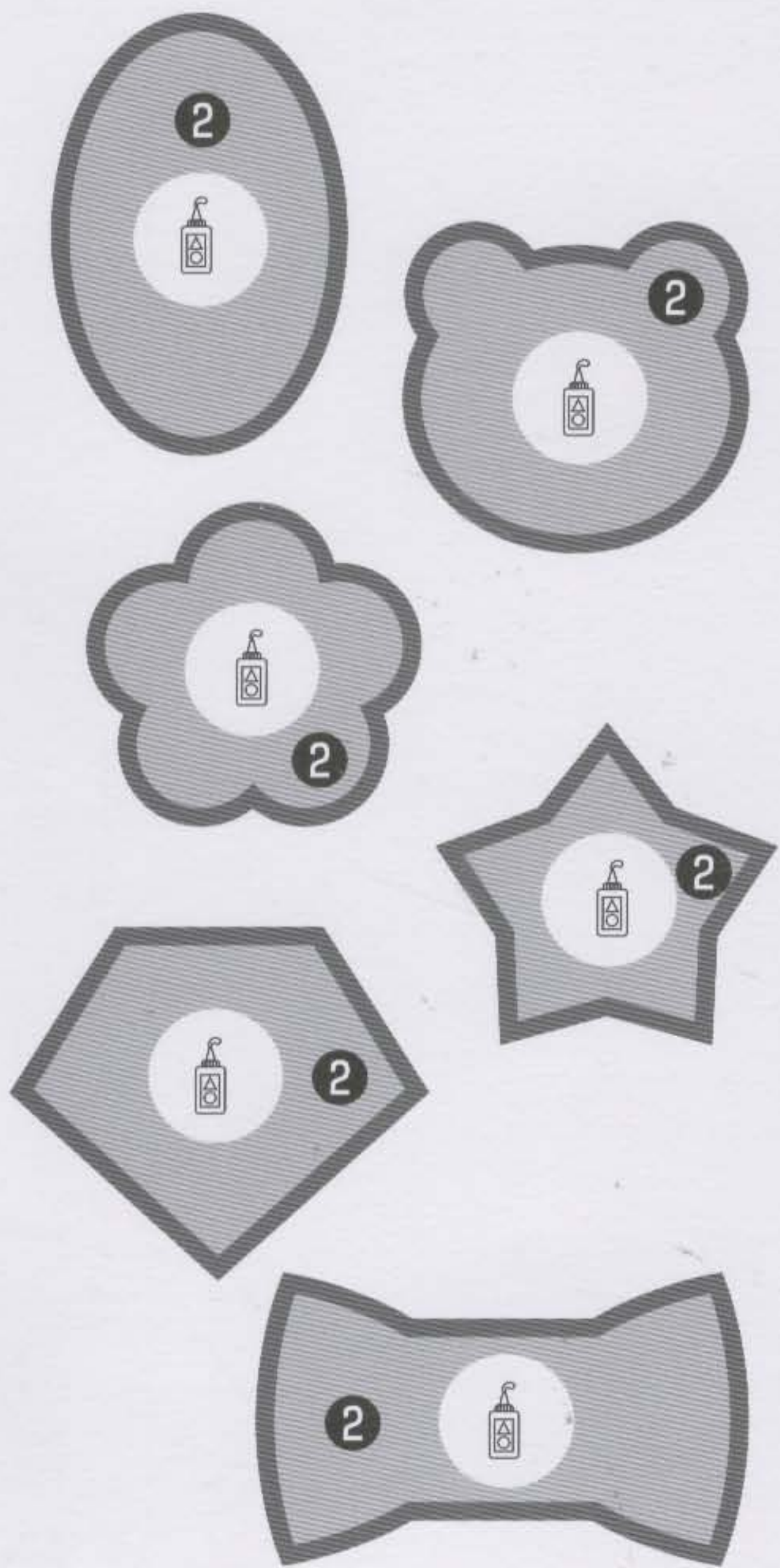

# 3

## Cat Mask

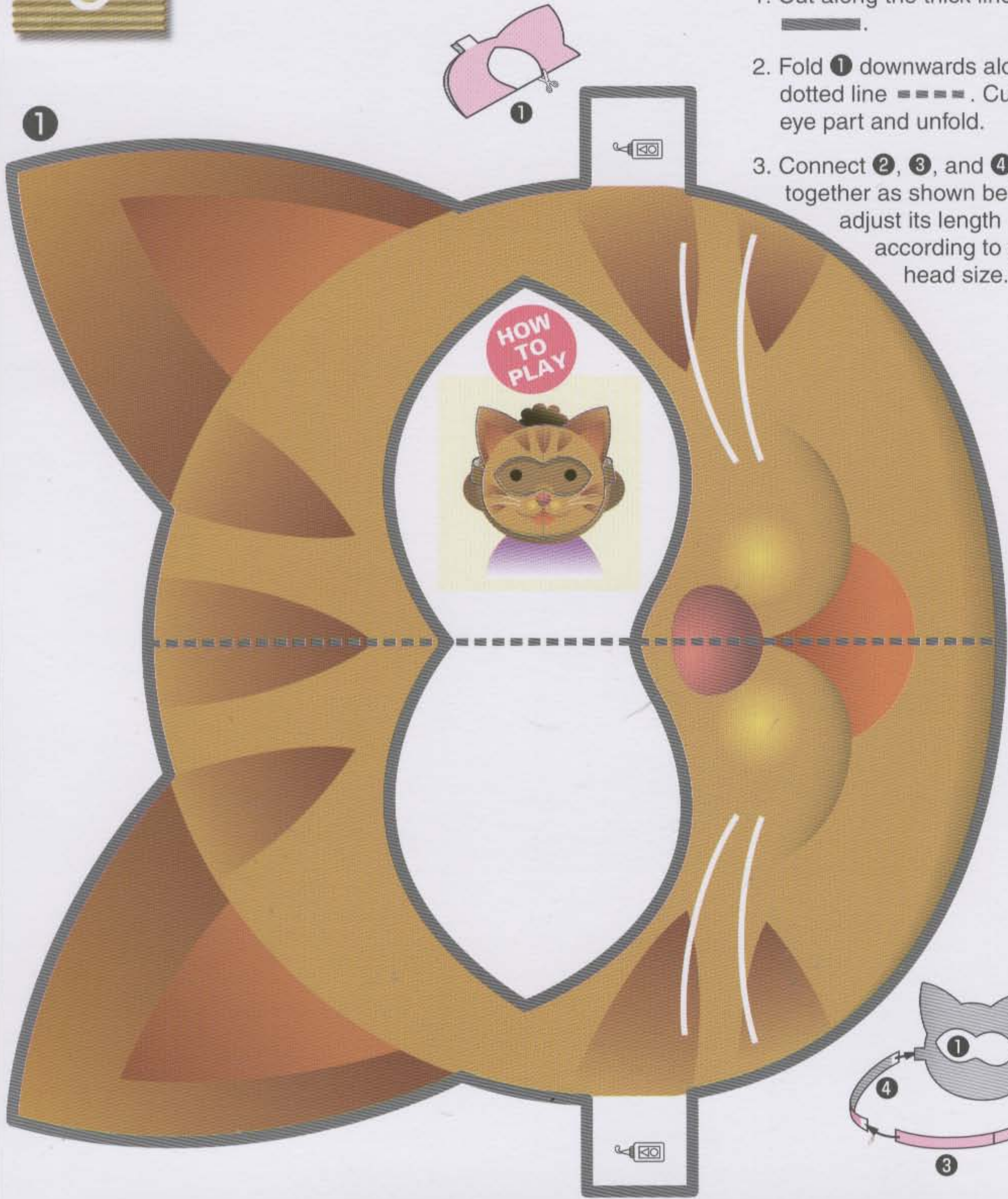

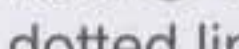
1. Cut along the thick lines .
2. Fold ① downwards along the dotted line . Cut out the eye part and unfold.
3. Connect ②, ③, and ④ together as shown below and adjust its length according to your head size.

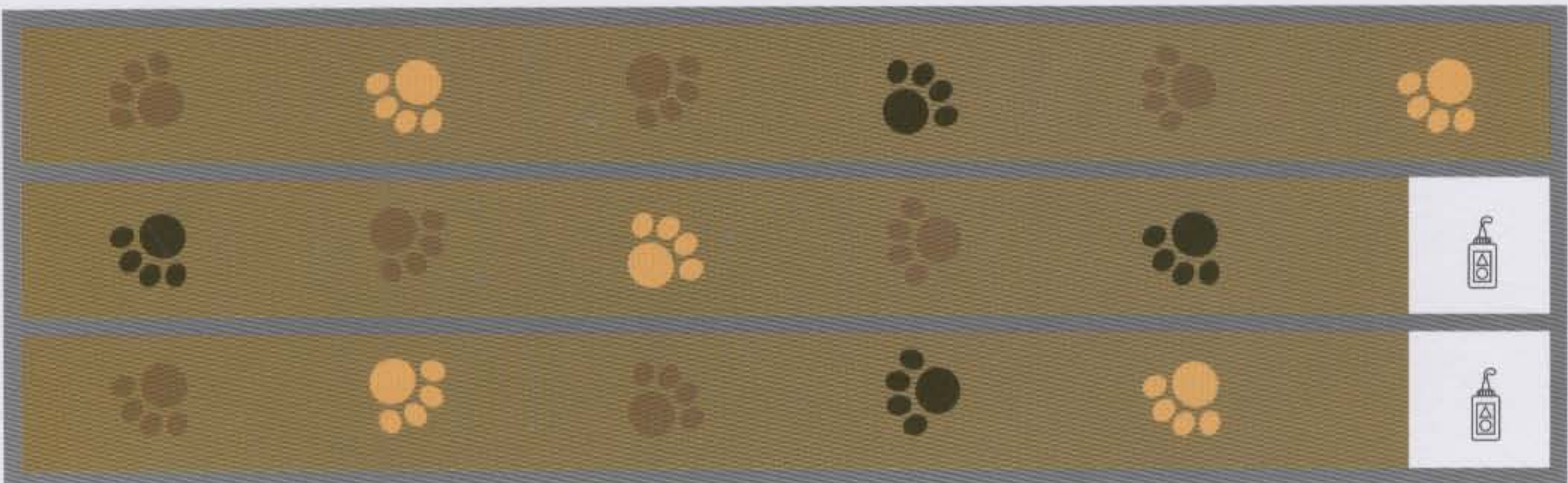
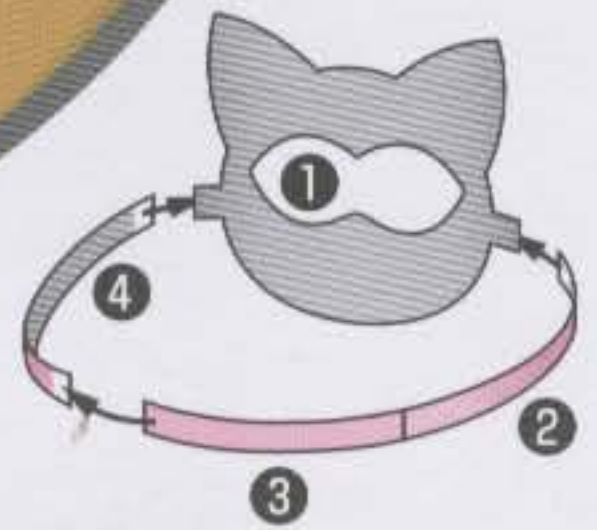

\*Parents, please cut along this line for your child.

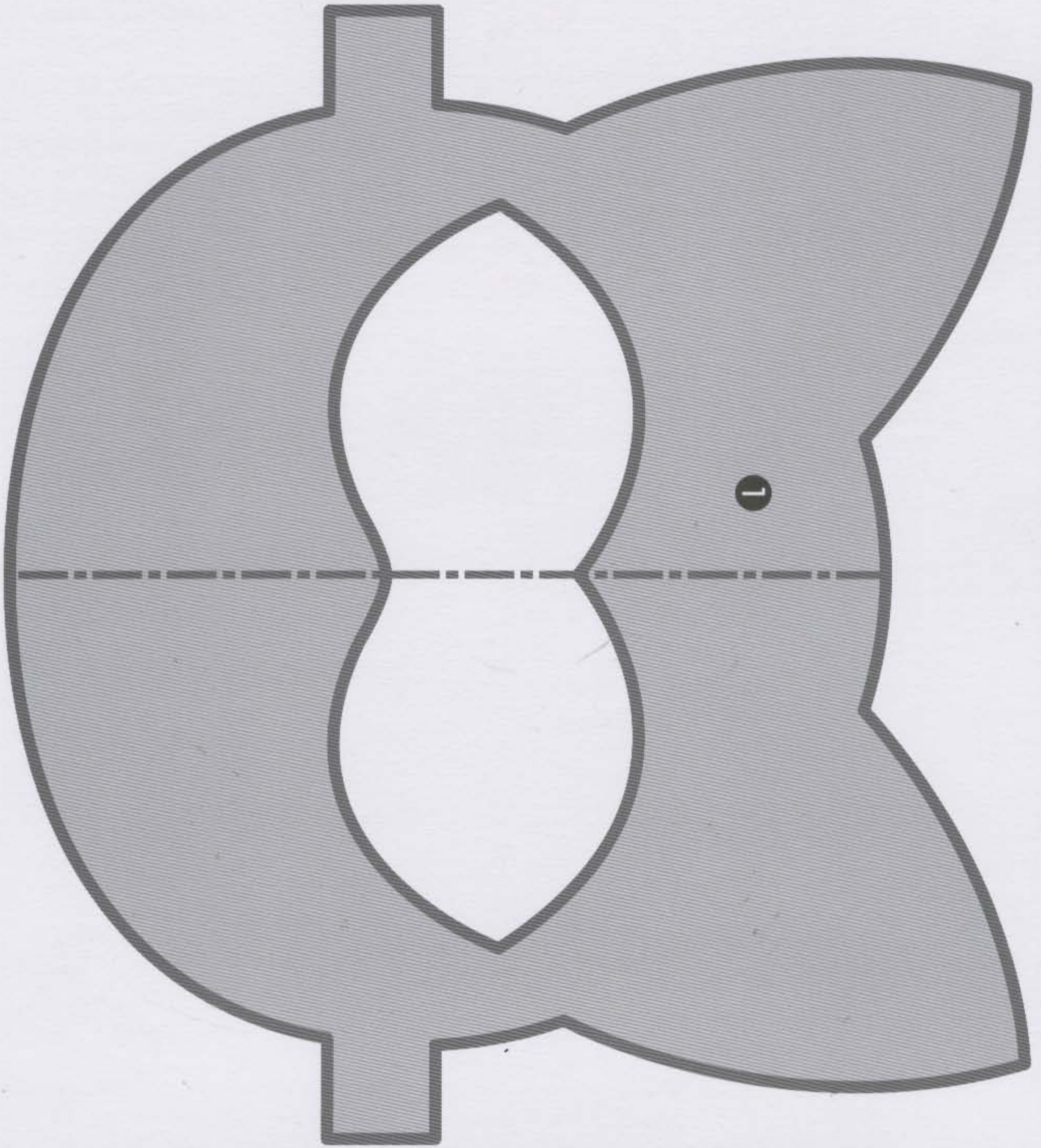



# 4

## Raccoon Mask

1. Cut along the thick lines .

2. Fold **1** downwards along the dotted line . Cut out the eye part and unfold.

3. Connect **2**, **3**, and **4** together as shown below and adjust its length according to your head size.

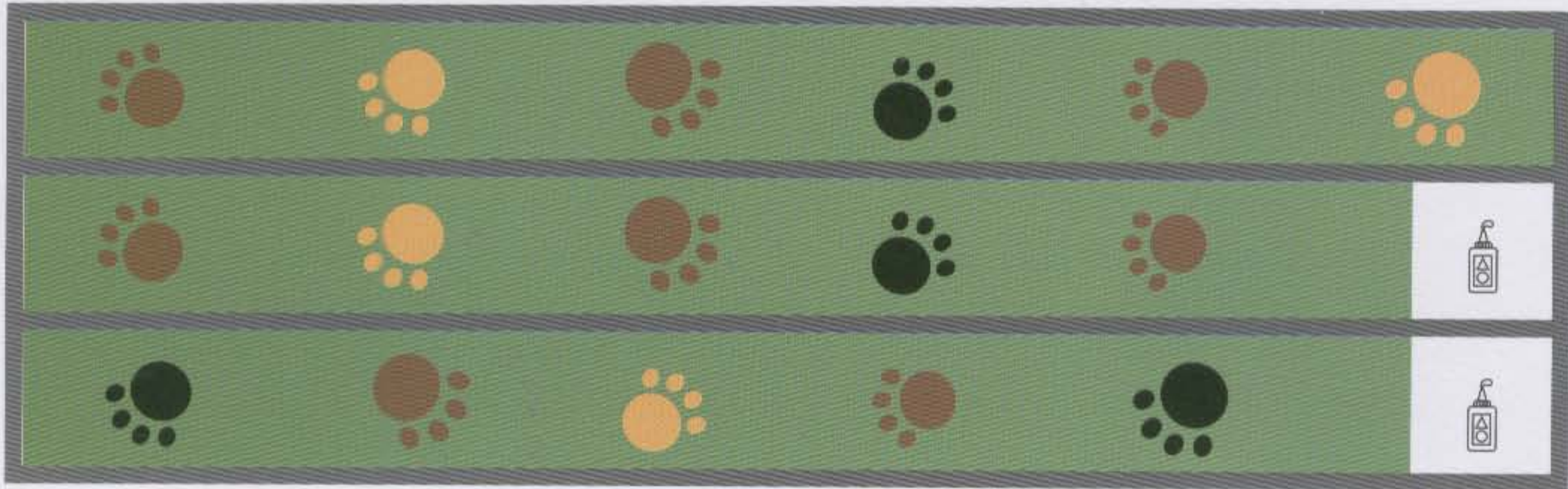
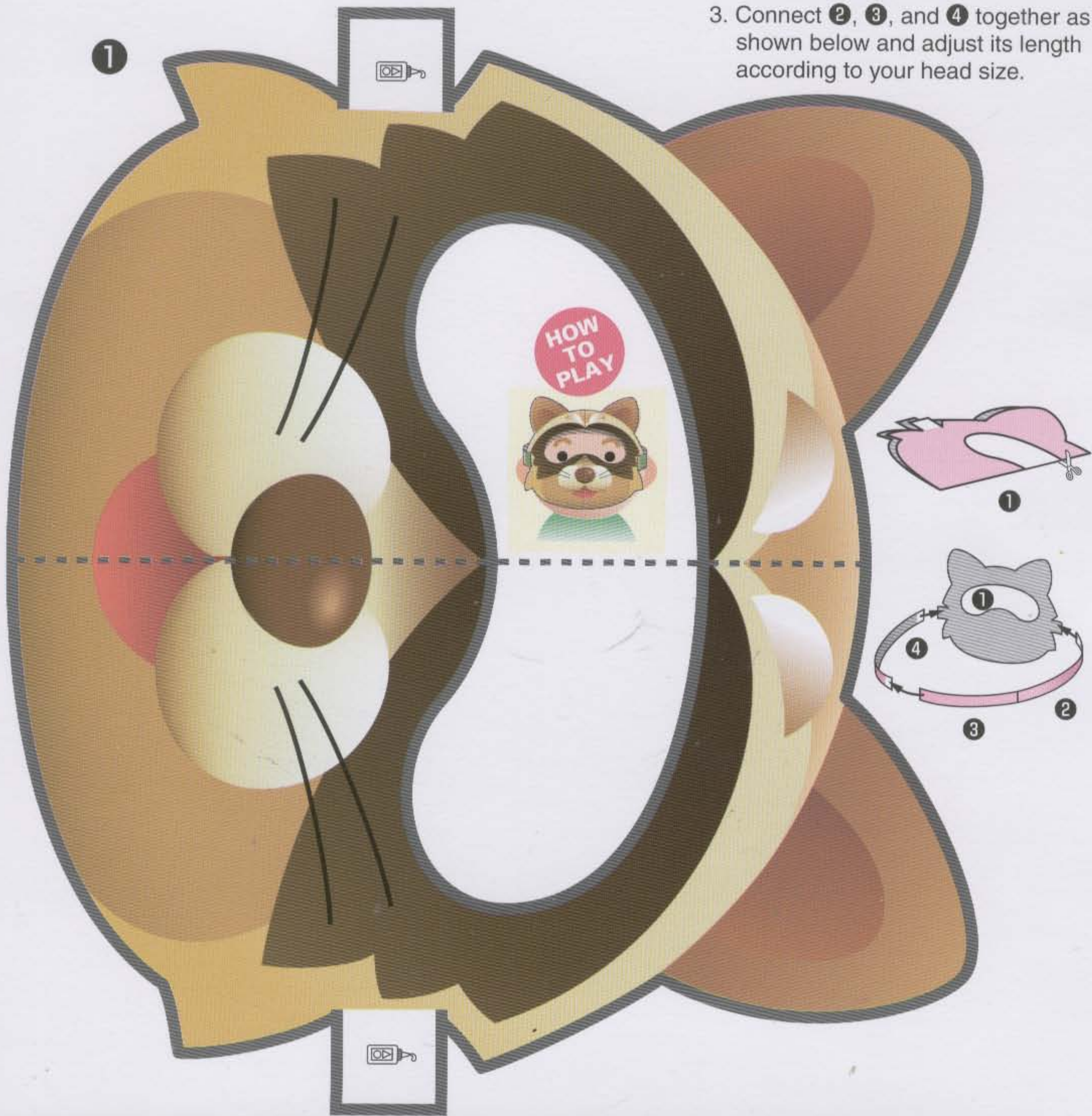

\*Parents, please cut along this line for your child.

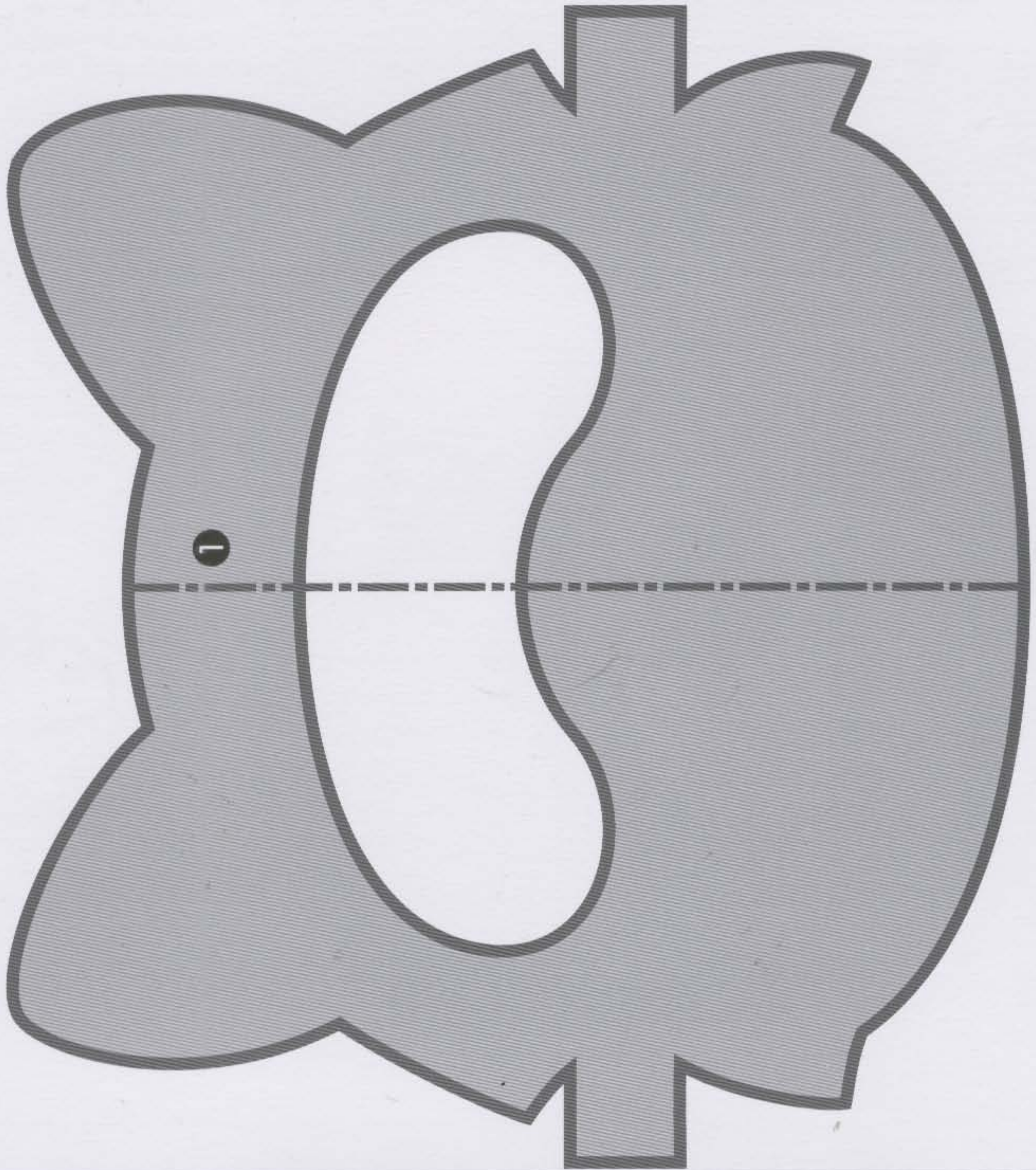

# 5

## Finger Puppets

1. Cut along the thick lines .
2. Roll the half circle part of each piece and adjust the circumference according to your finger size. Paste the edges together.



**HOW TO PLAY**

Put the puppets onto your fingers and play.



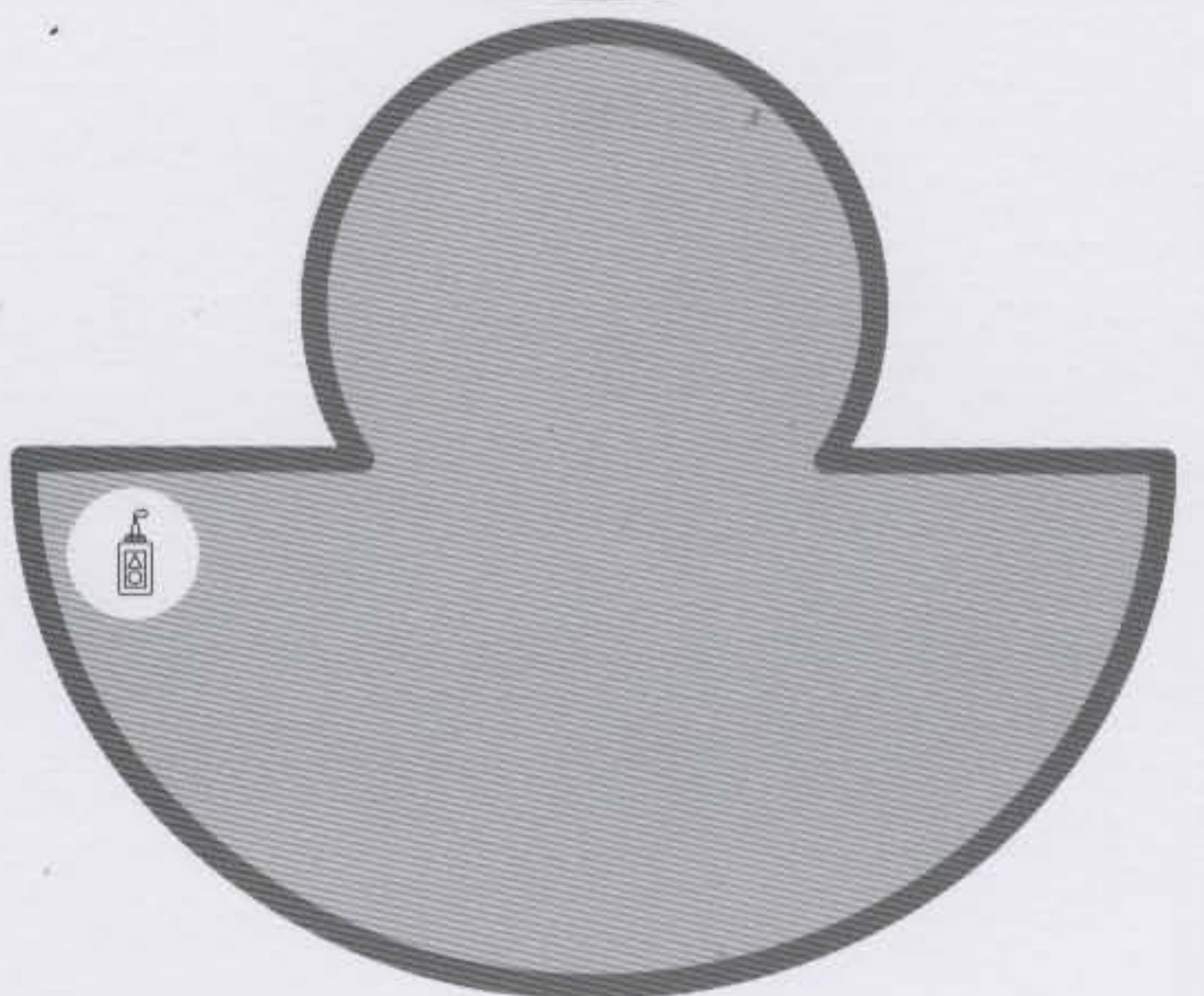
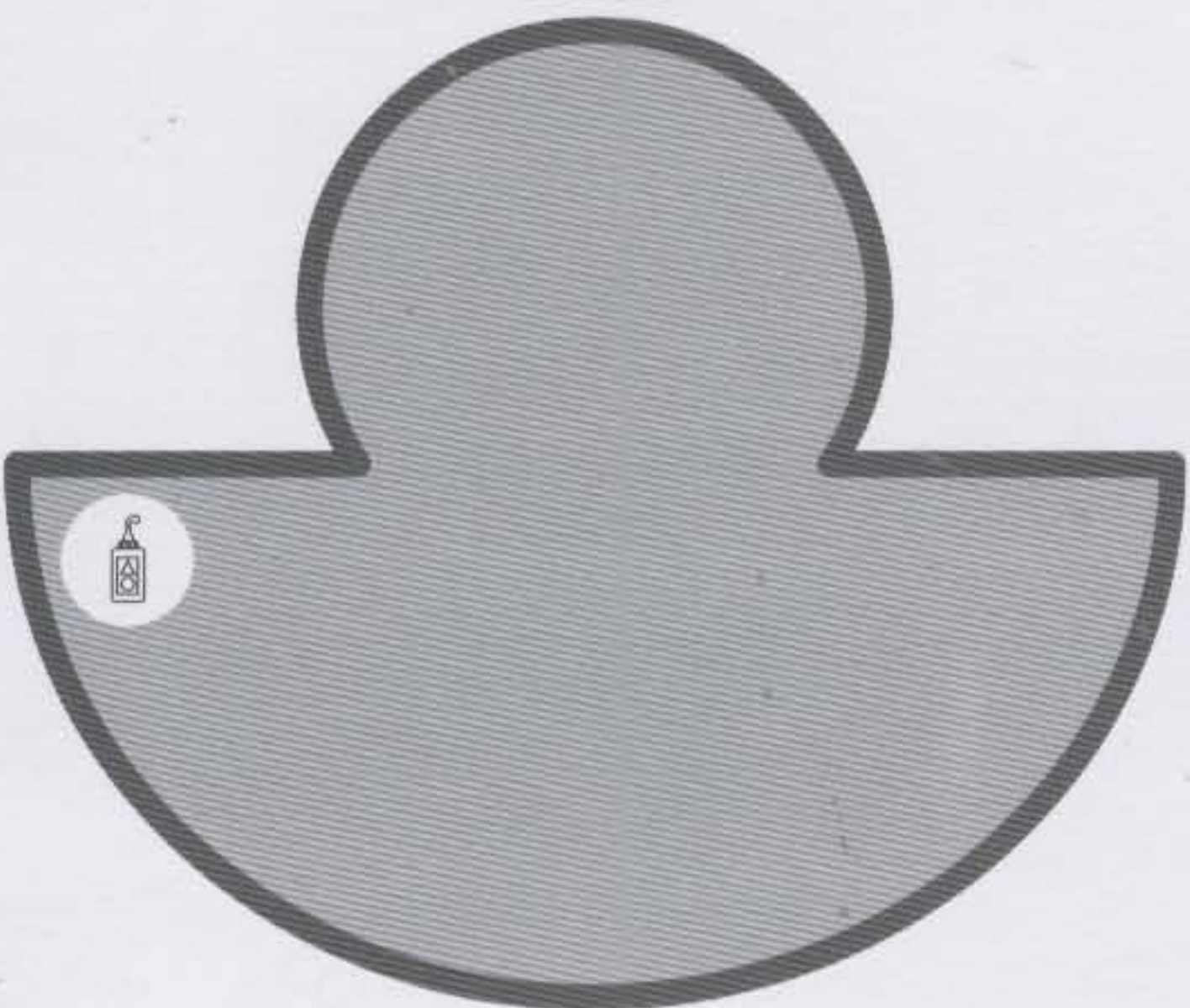
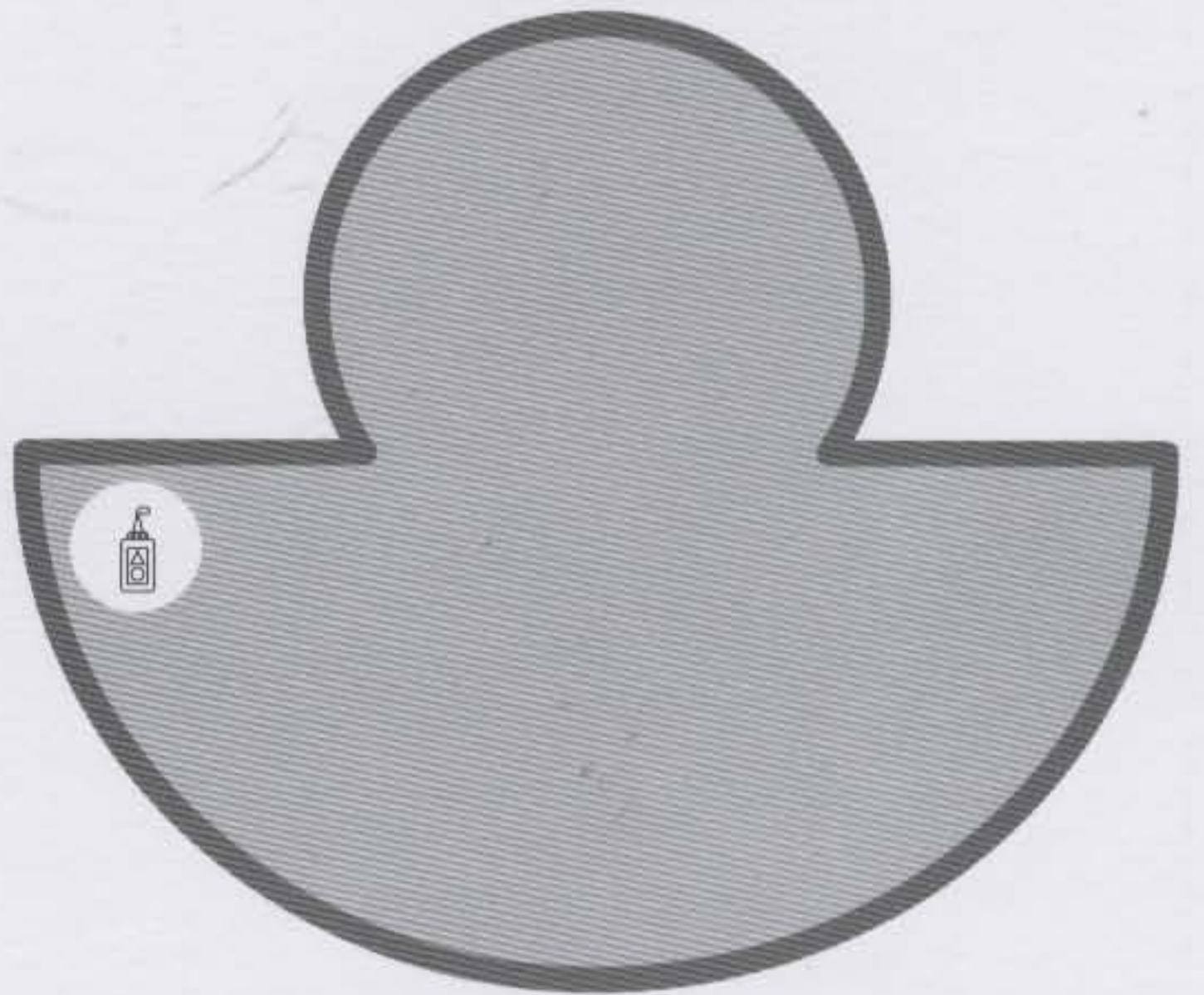
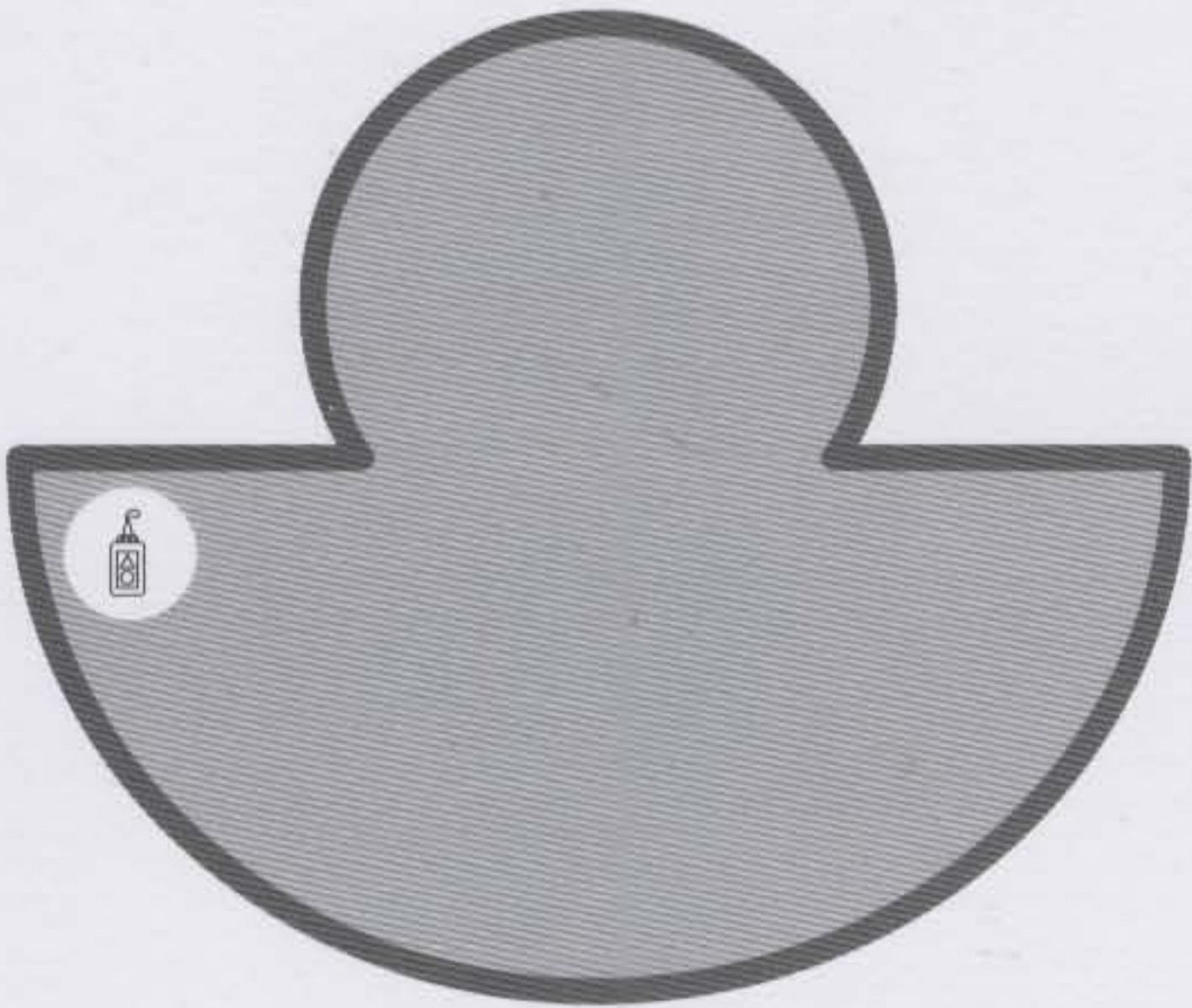
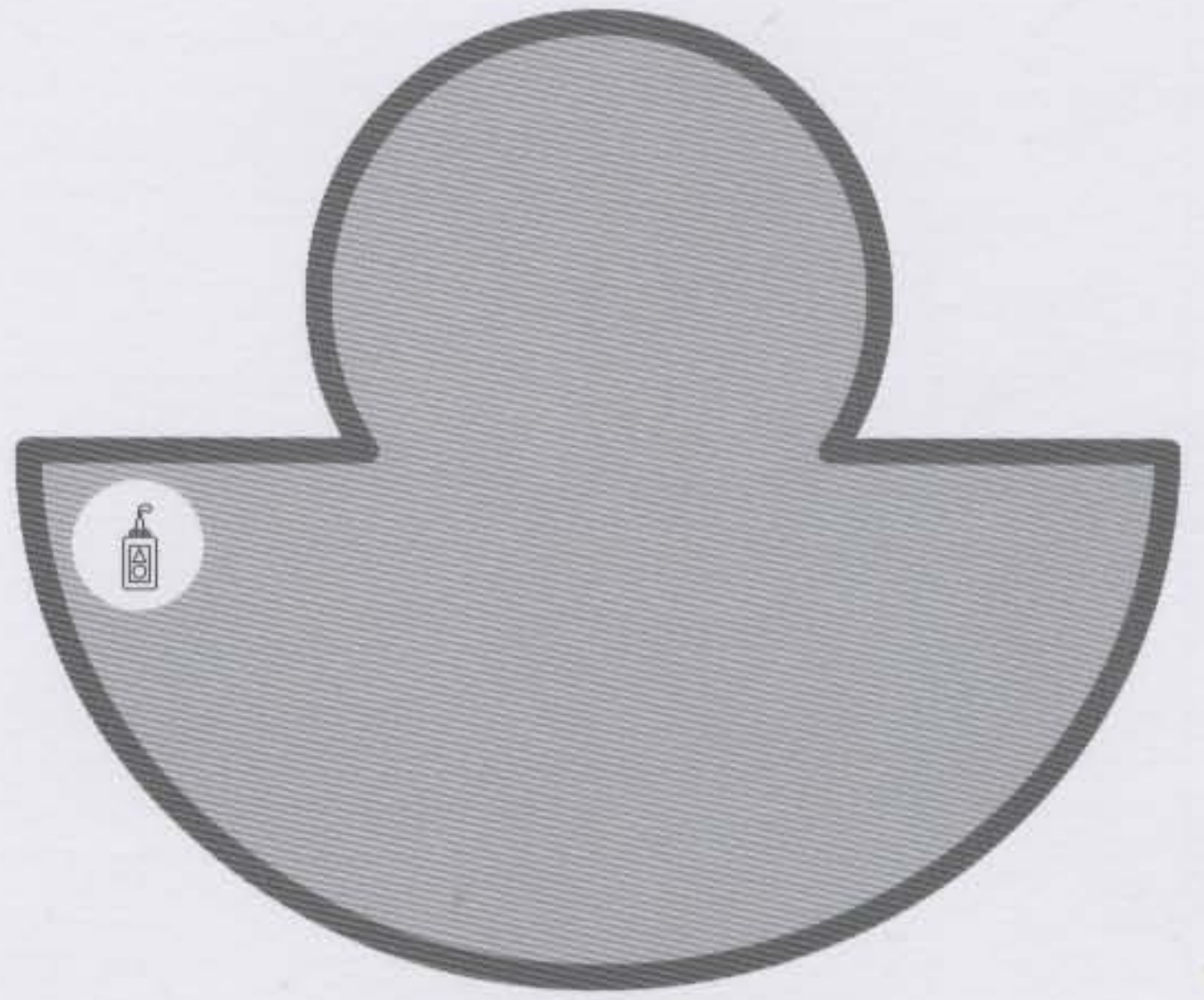



6

# Surfing

HOW TO PLAY

Blow from behind. The animals will surf.

1. Cut along the thick lines .
2. Fold each piece upwards along the dashed line .

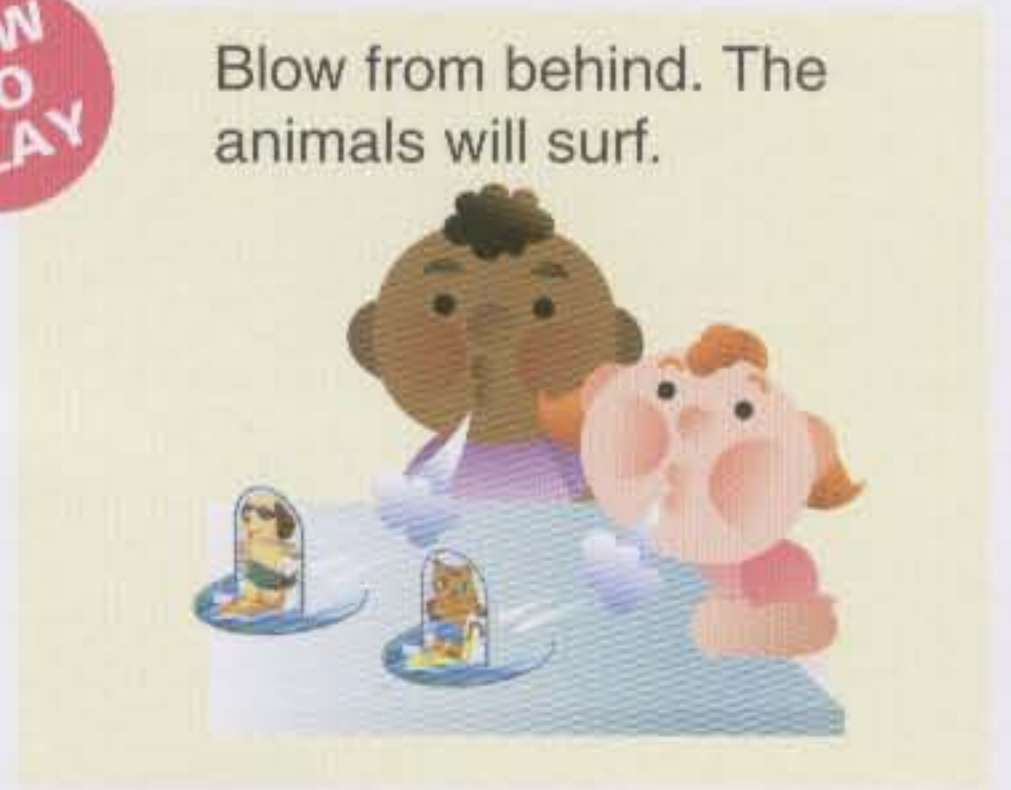
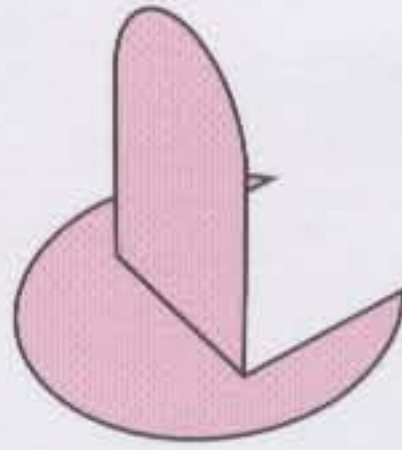

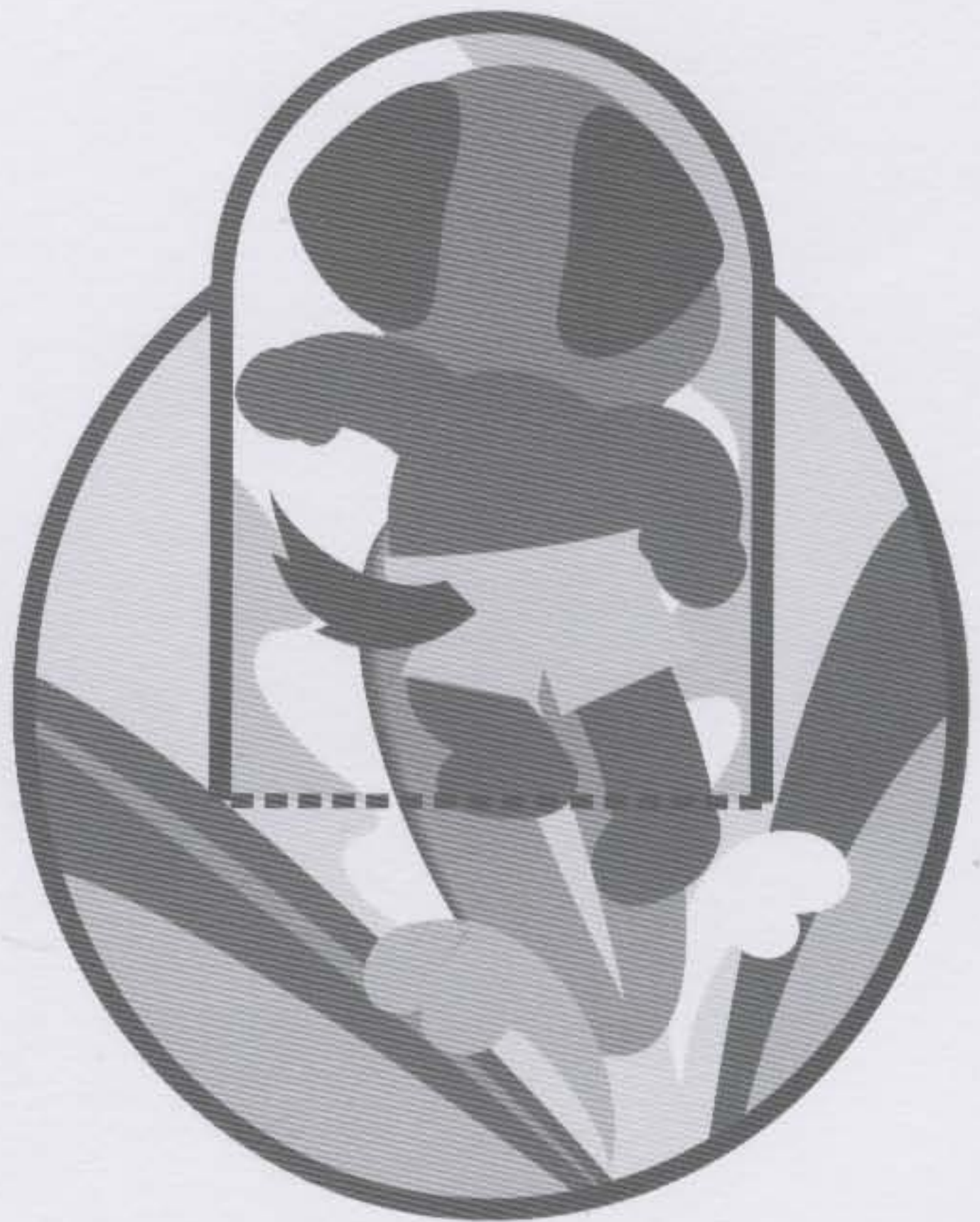

# 7

## Long, Long Snake

1. Cut along the thick lines .
2. Connect all parts together as shown below.

HOW TO PLAY

Curl it or fold it in an accordion style.

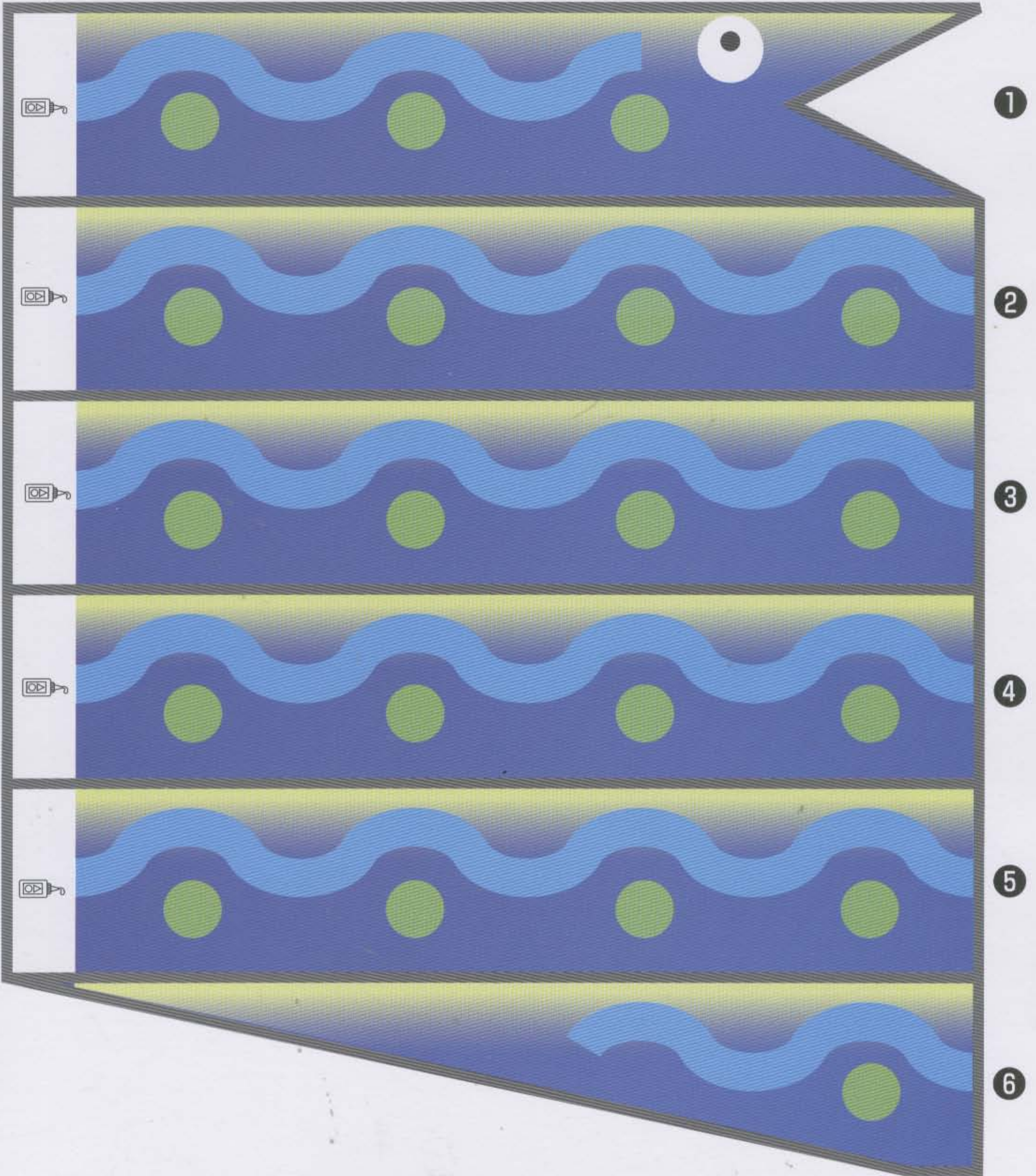
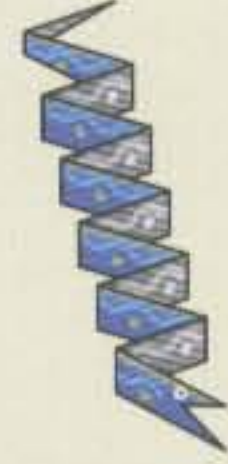

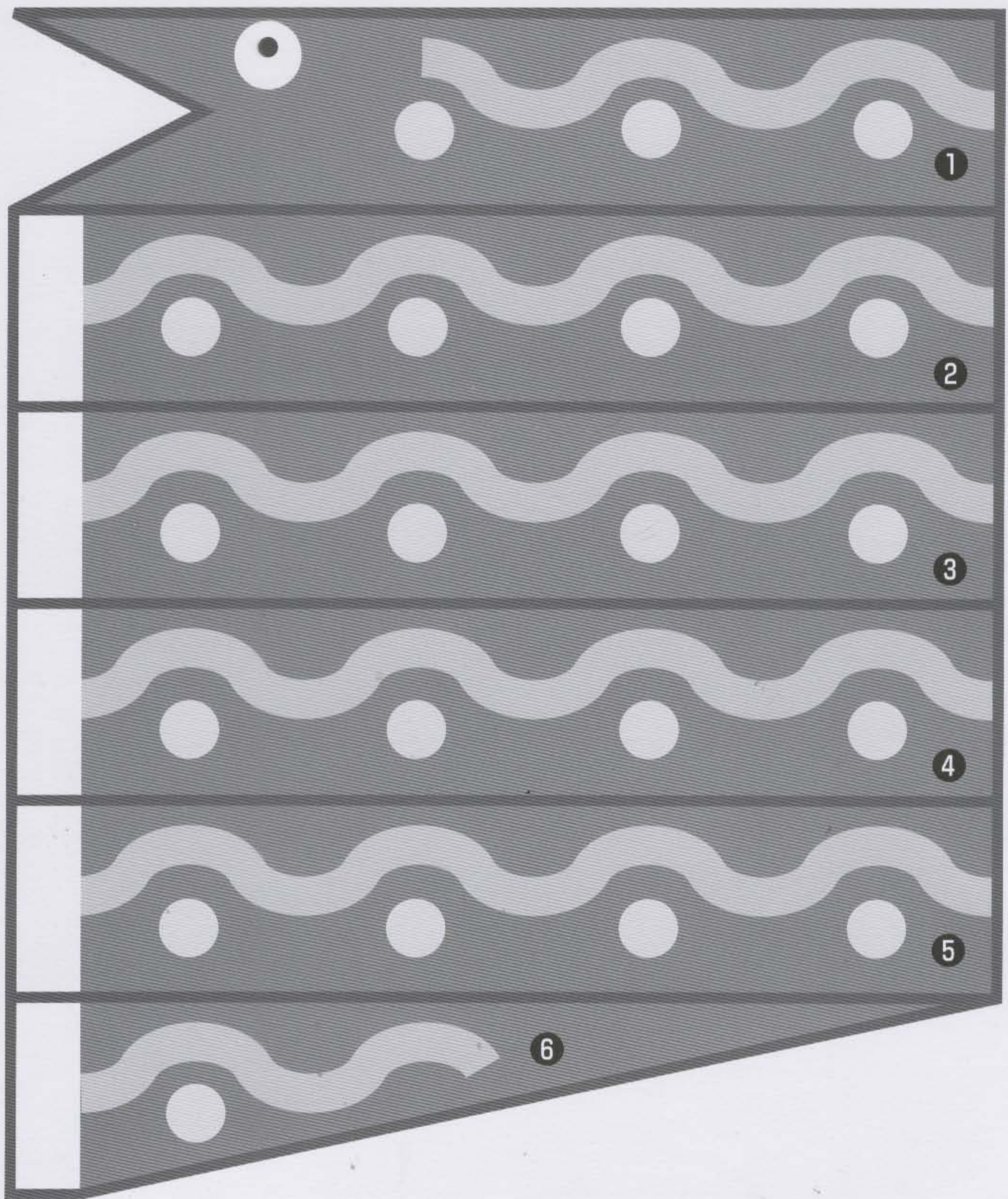

\*Parents, please cut along this line for your child.





# Cries and Smiles

1. Cut along the thick lines .
2. Fold downwards along the dotted lines  and upwards along the dashed line .

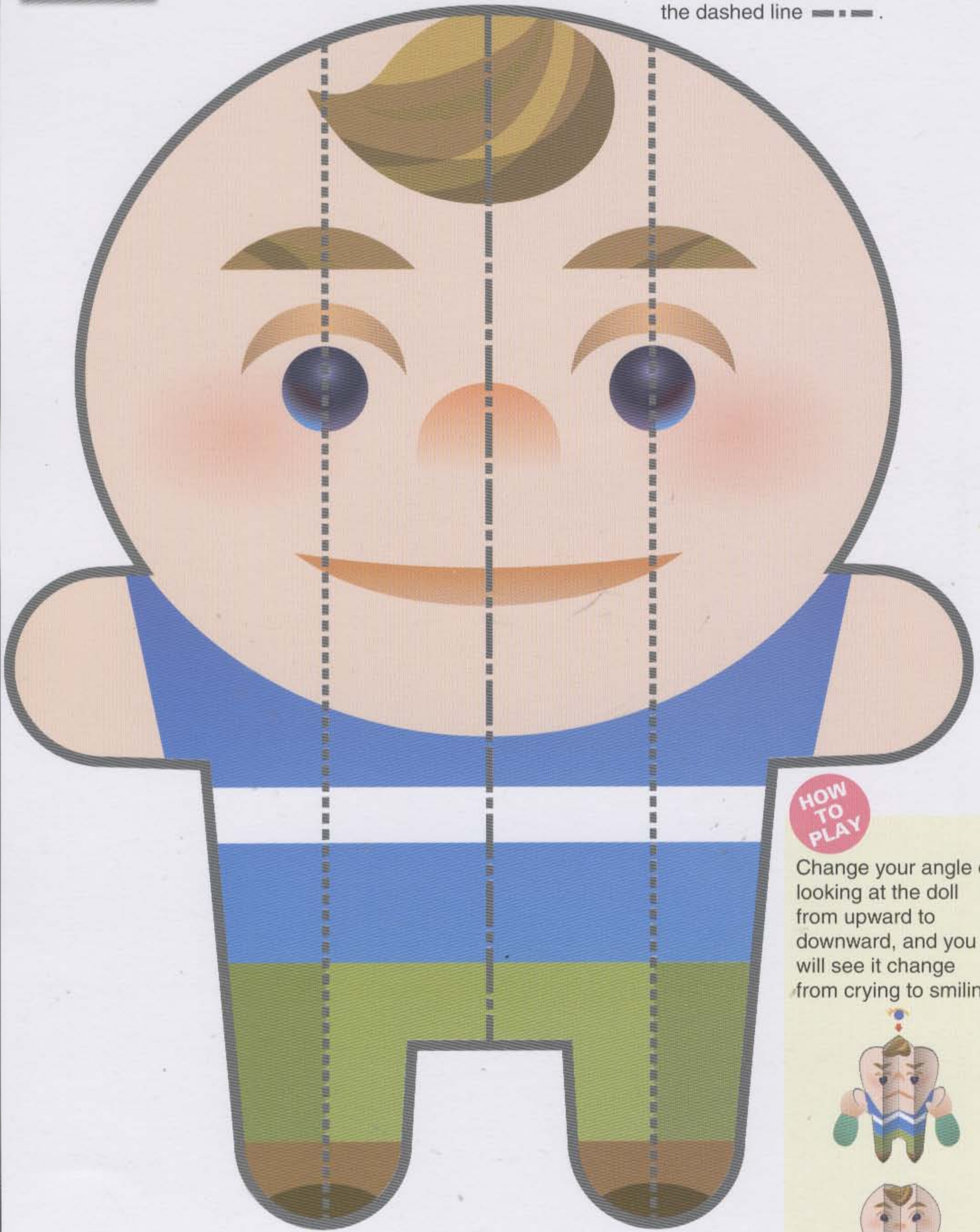

## HOW TO PLAY

Change your angle of looking at the doll from upward to downward, and you will see it change from crying to smiling.

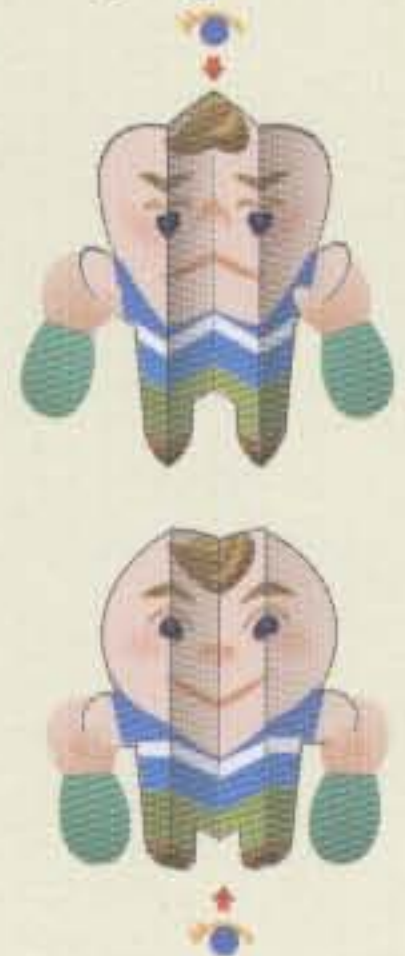

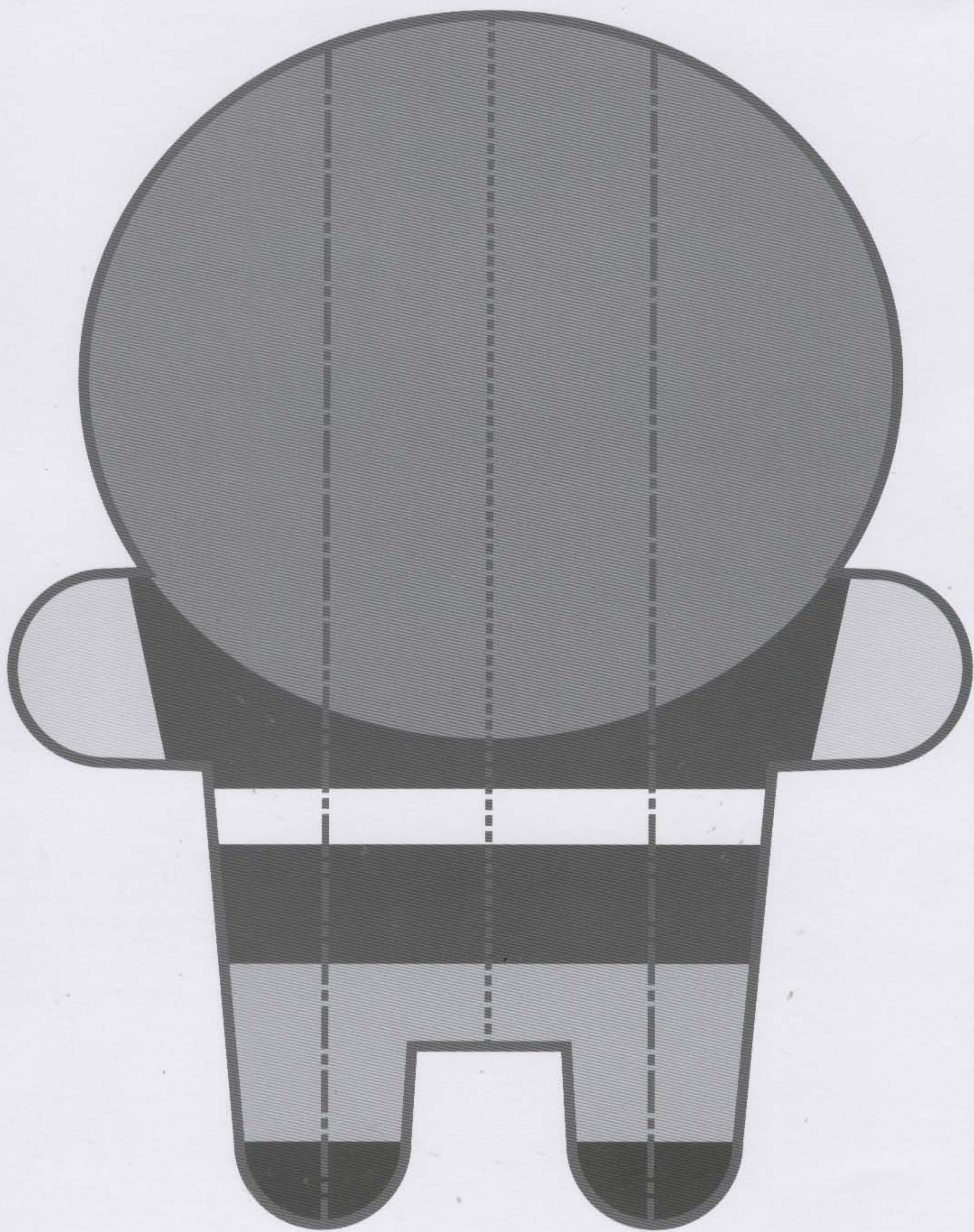



9

# Wriggling Fish



1. Cut along the thick lines .
2. Fold the fish in half by folding downwards along the dotted line .

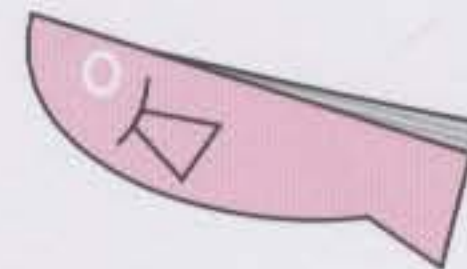

HOW TO PLAY



Pinch the tail with your fingers and rub the sides together. The fish will wriggle.



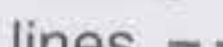

# 10

## Balancing Bird

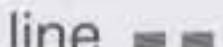
1. Cut along the thick lines .
2. Fold ① downwards along the dotted lines  and upwards along the dashed line .
3. Tuck in and paste the edges of the wings.
4. Fold ② downwards along the dotted line . Paste it onto ①.

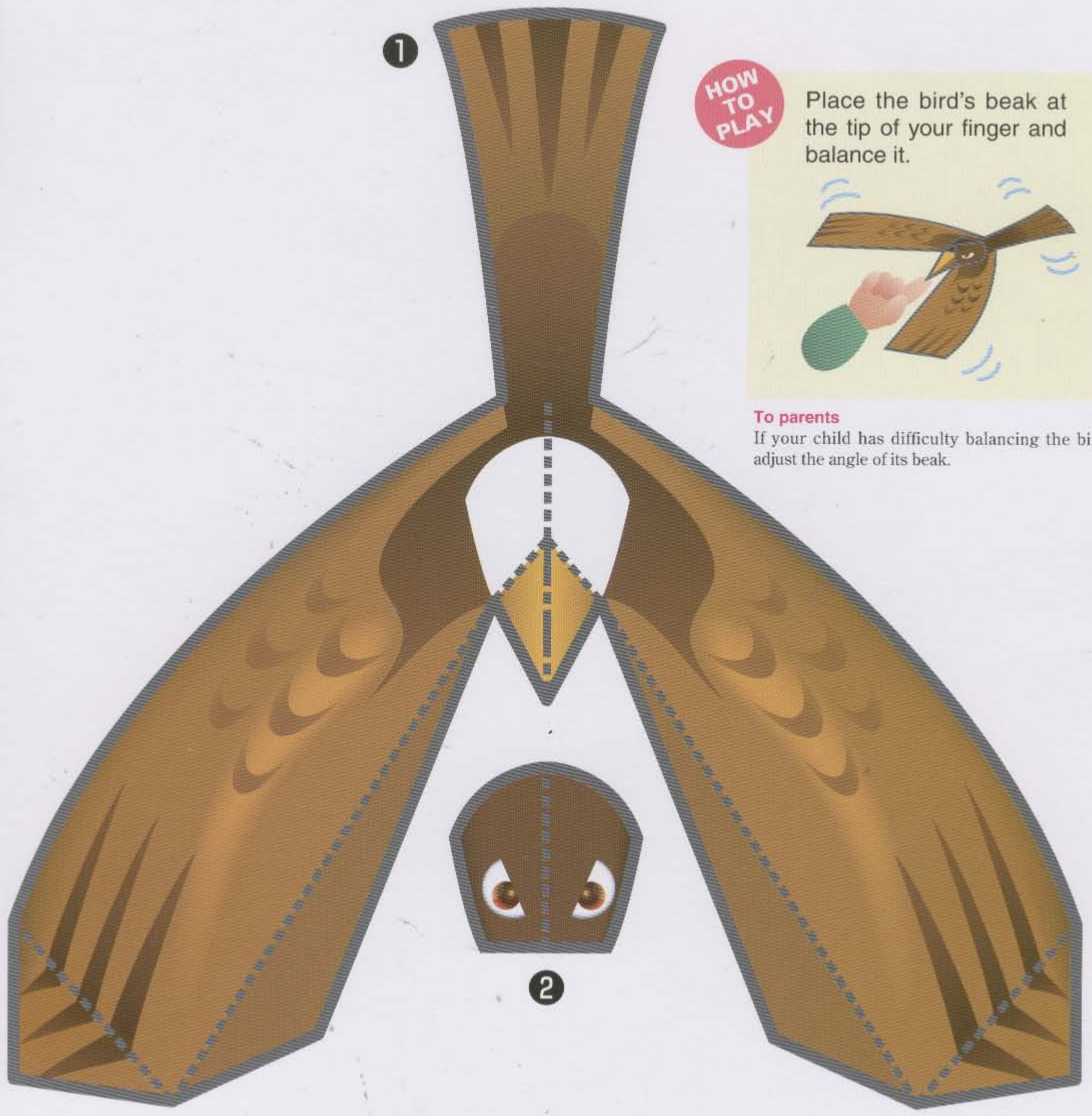
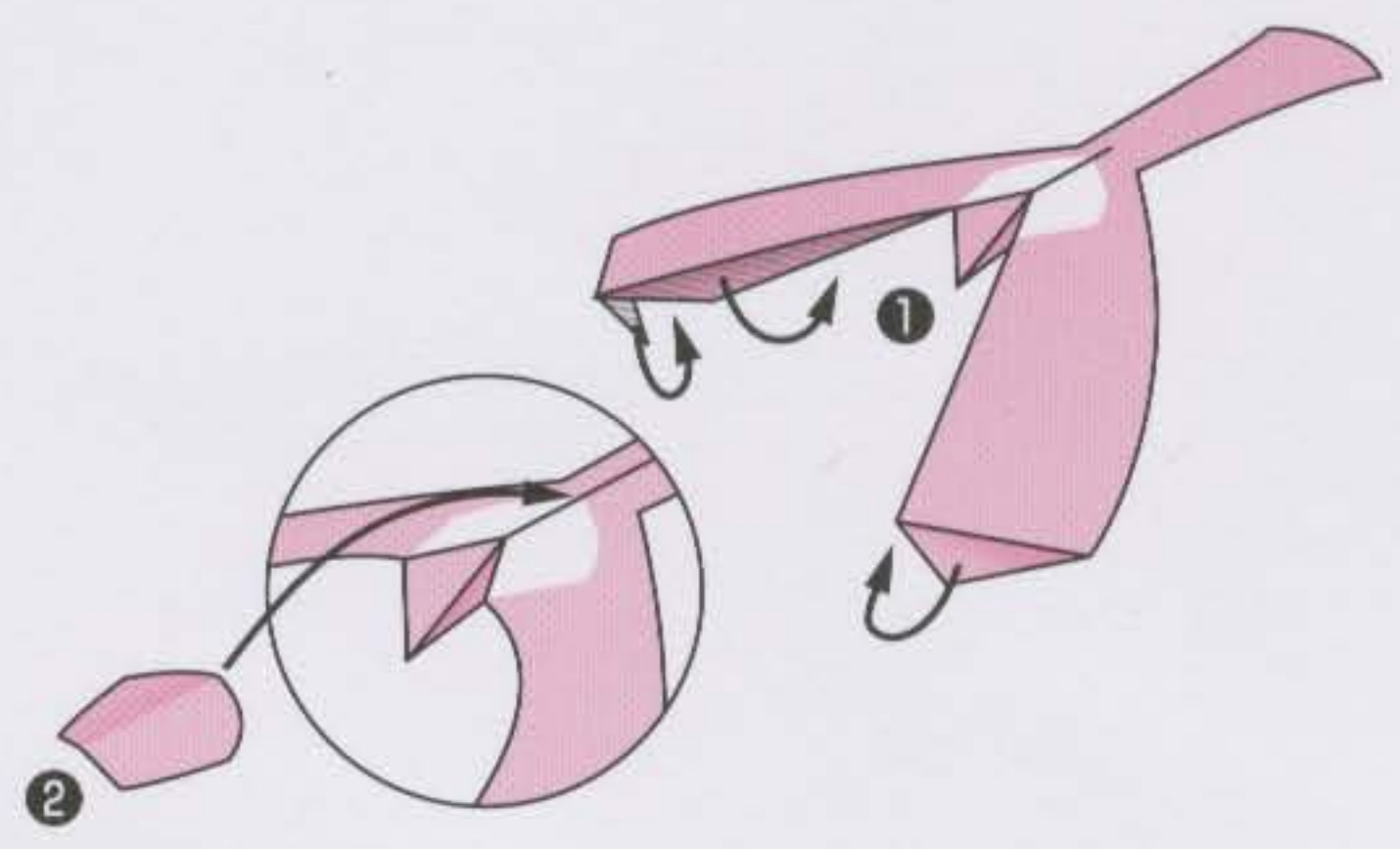

### HOW TO PLAY

Place the bird's beak at the tip of your finger and balance it.



### To parents

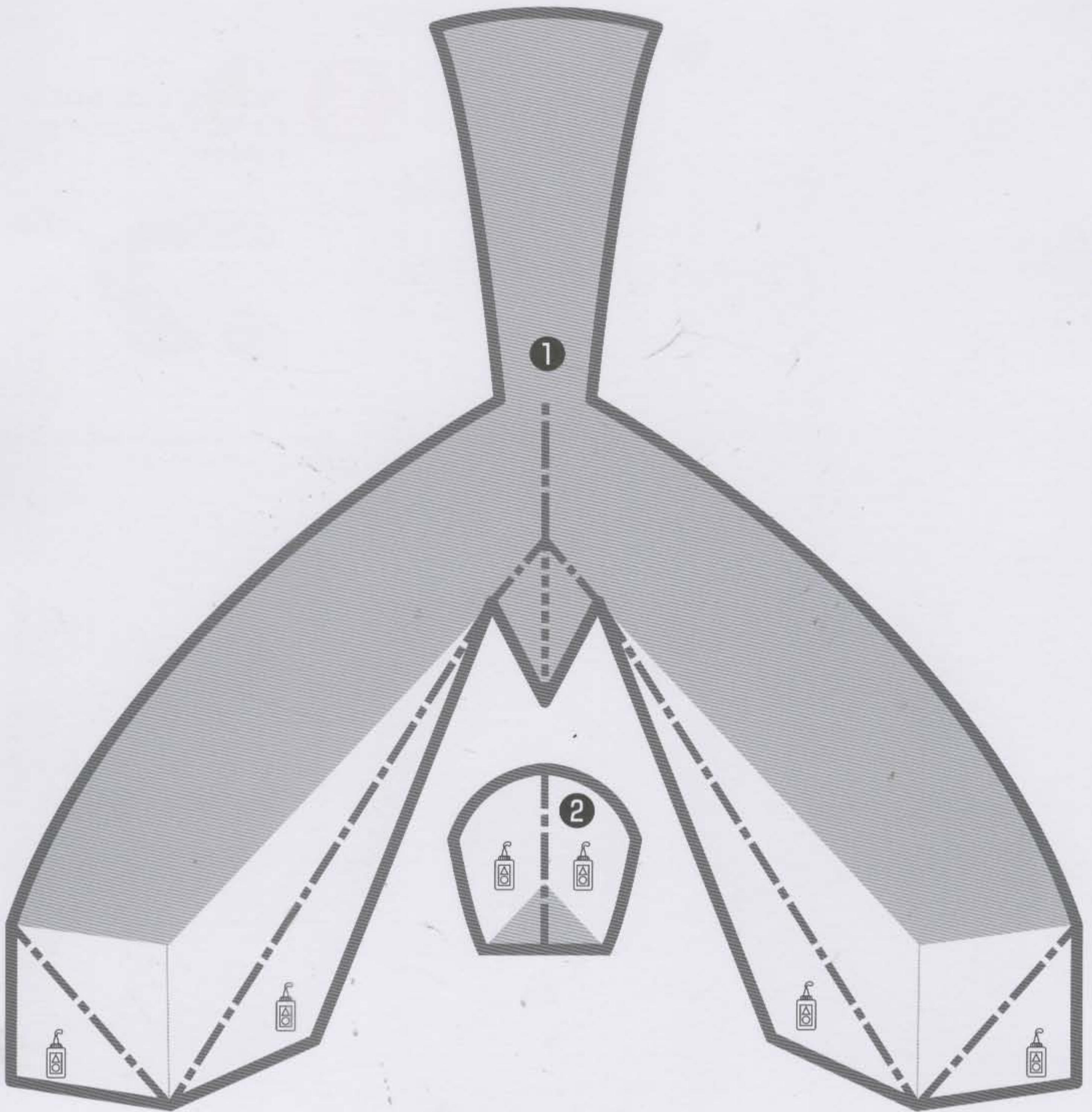

If your child has difficulty balancing the bird, adjust the angle of its beak.

\*Parents, please cut along this line for your child.

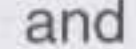

# 11

## Leap!

1. Cut along the thick lines .
2. Fold downwards along the dotted lines  and upwards along the dashed lines .

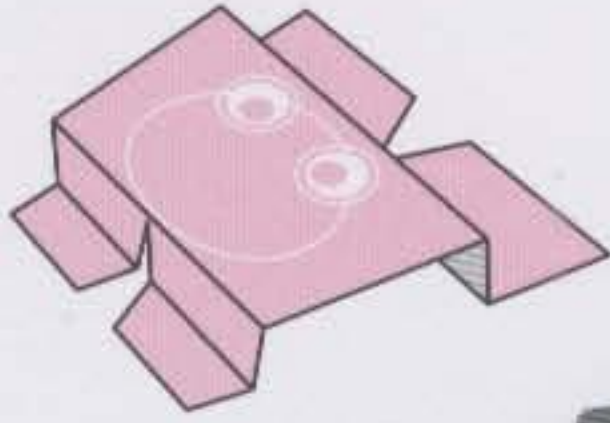

HOW TO PLAY

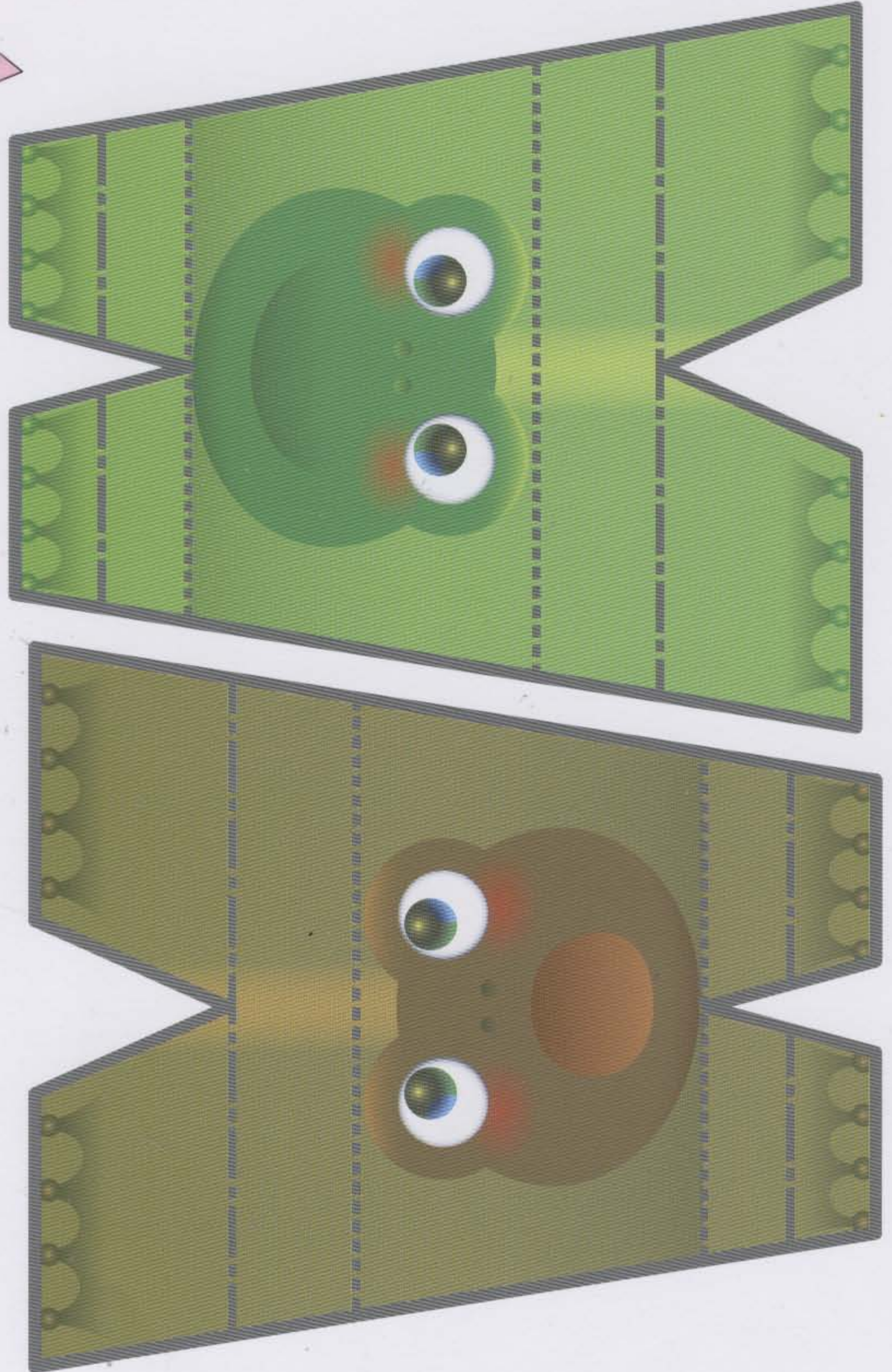

Push down the edge of each frog's back and release. The frog will leap.

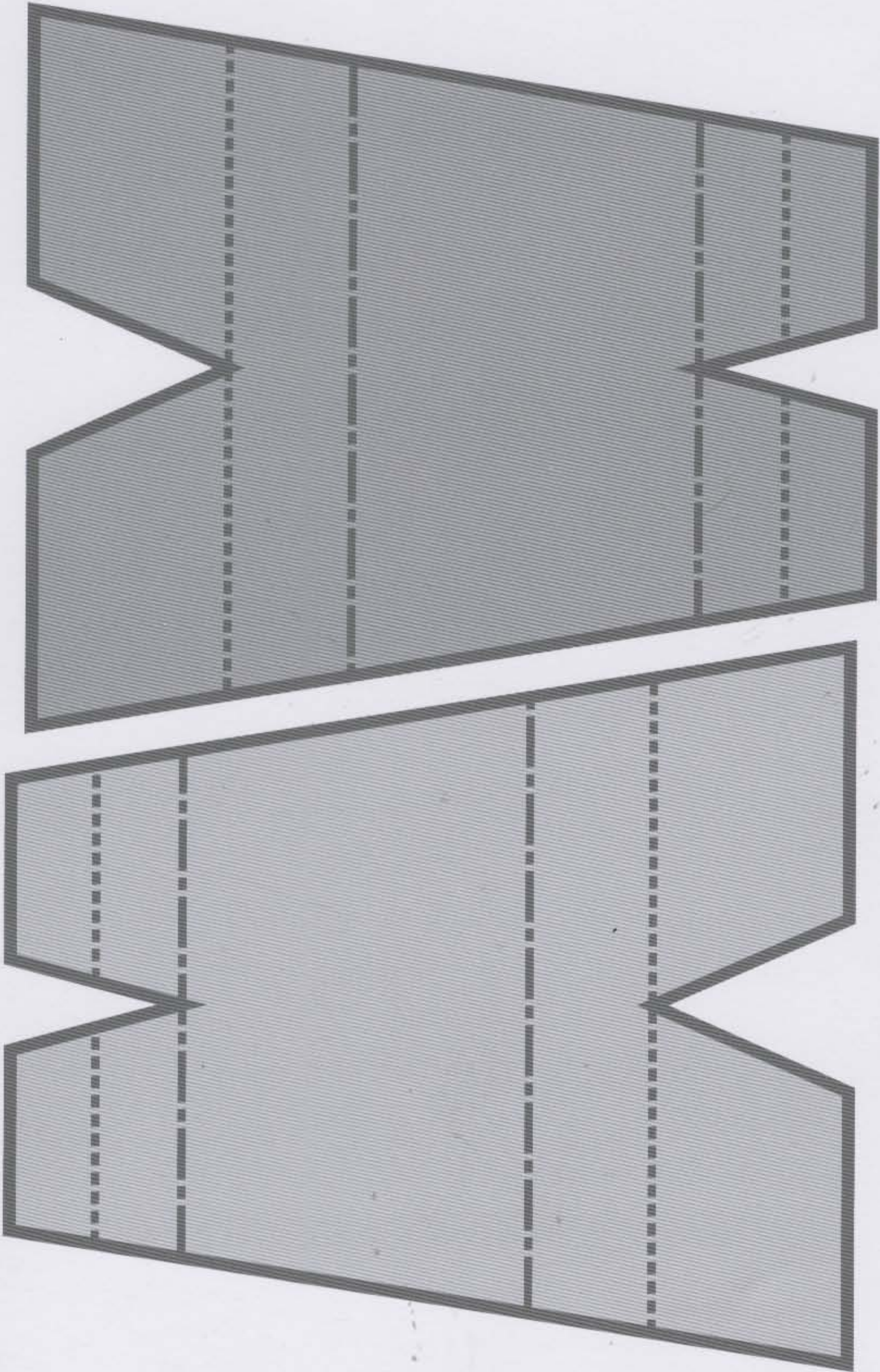



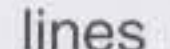

# Belly Landing

1. Cut along the thick lines .
2. Fold downwards along the dotted lines  and upwards along the dashed lines .

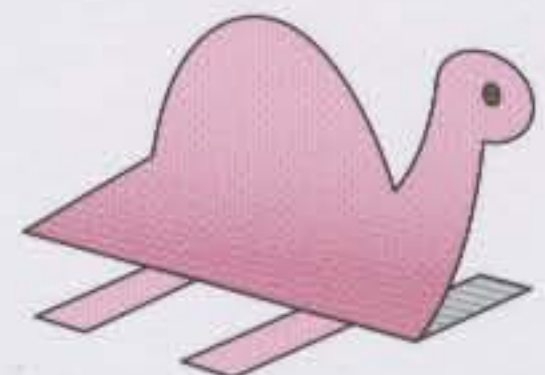

**HOW TO PLAY**

Pick the dinosaur up with your fingertips and toss it in the air.



\*Parents, please cut along this line for your child.

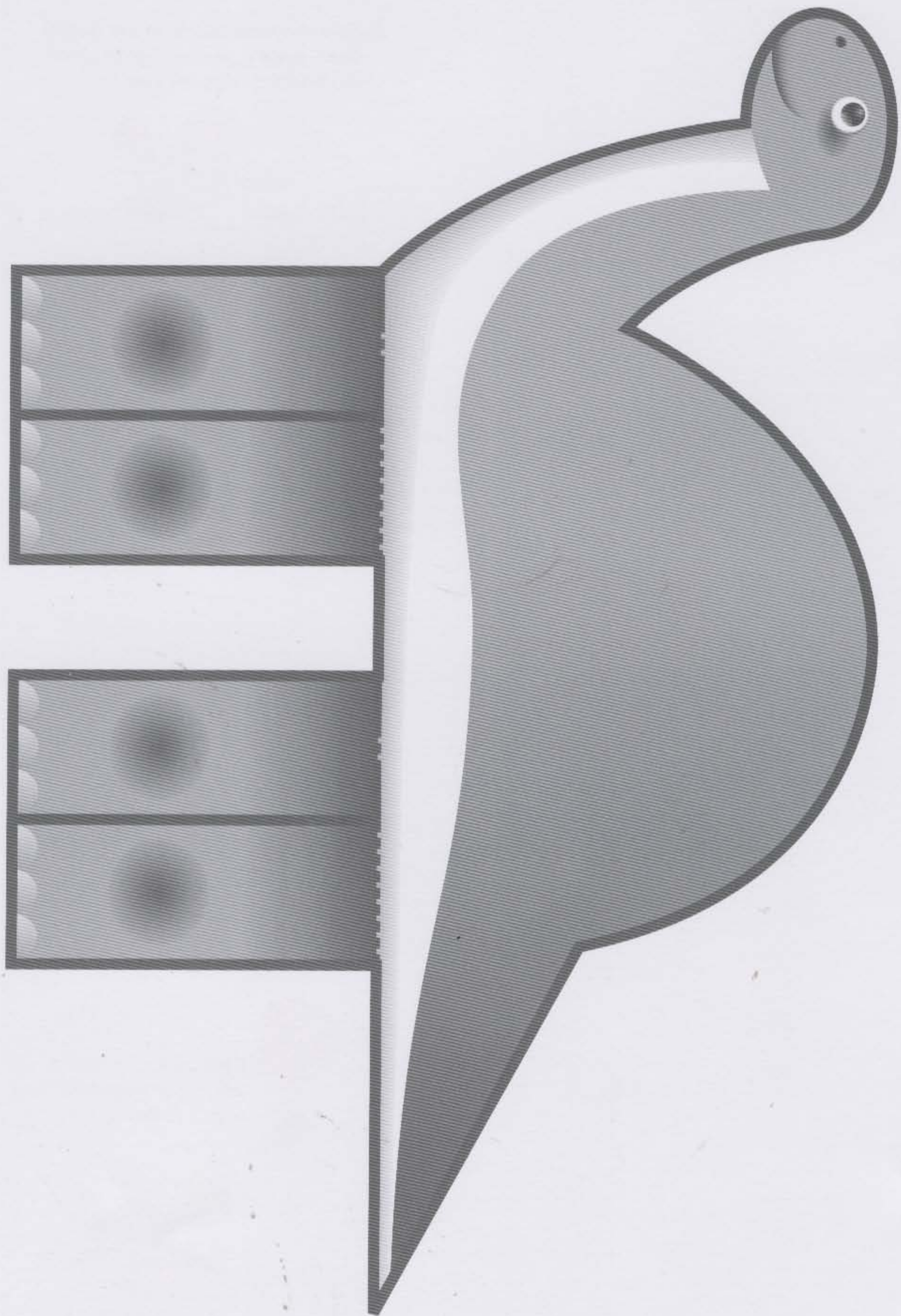



# 13

## Flying Pig

**HOW TO PLAY**

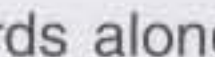
Fly the pig gently. Do not throw it too hard.

1. Cut along the thick lines .
2. Fold each part downwards along the dotted lines  and upwards along the dashed lines . Paste the backs of ②, ③, ④, and ⑤ as shown below.
3. Paste ②, ③, ④, and ⑤ together and attach onto the tip of ①.

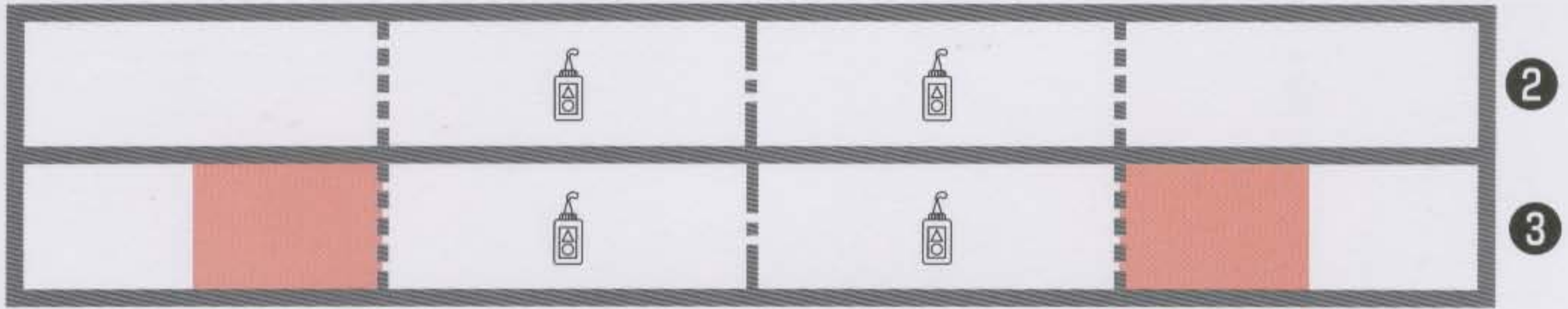
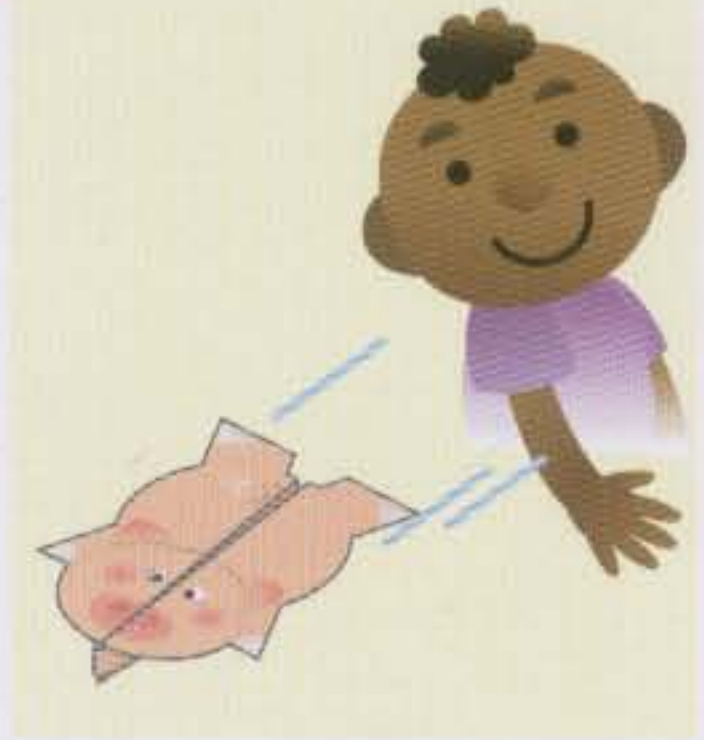
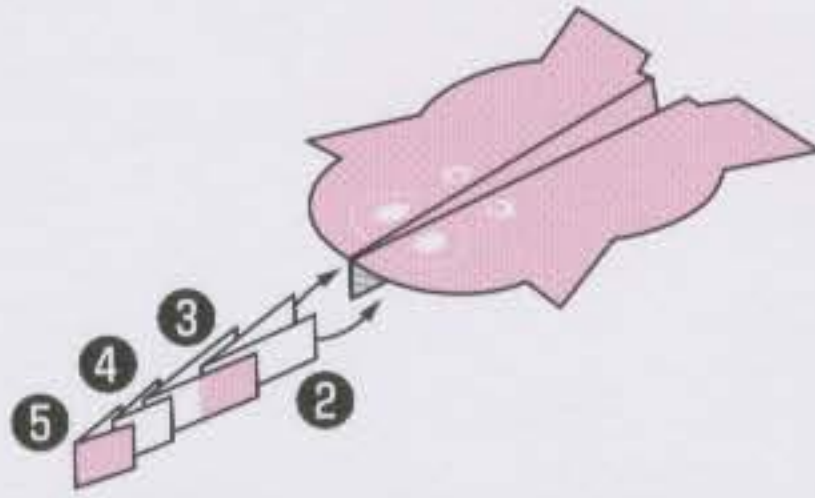
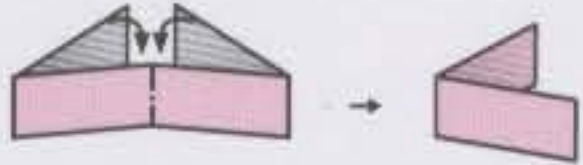

▼ How the pig should look from the front



Turn the wings slightly upwards.

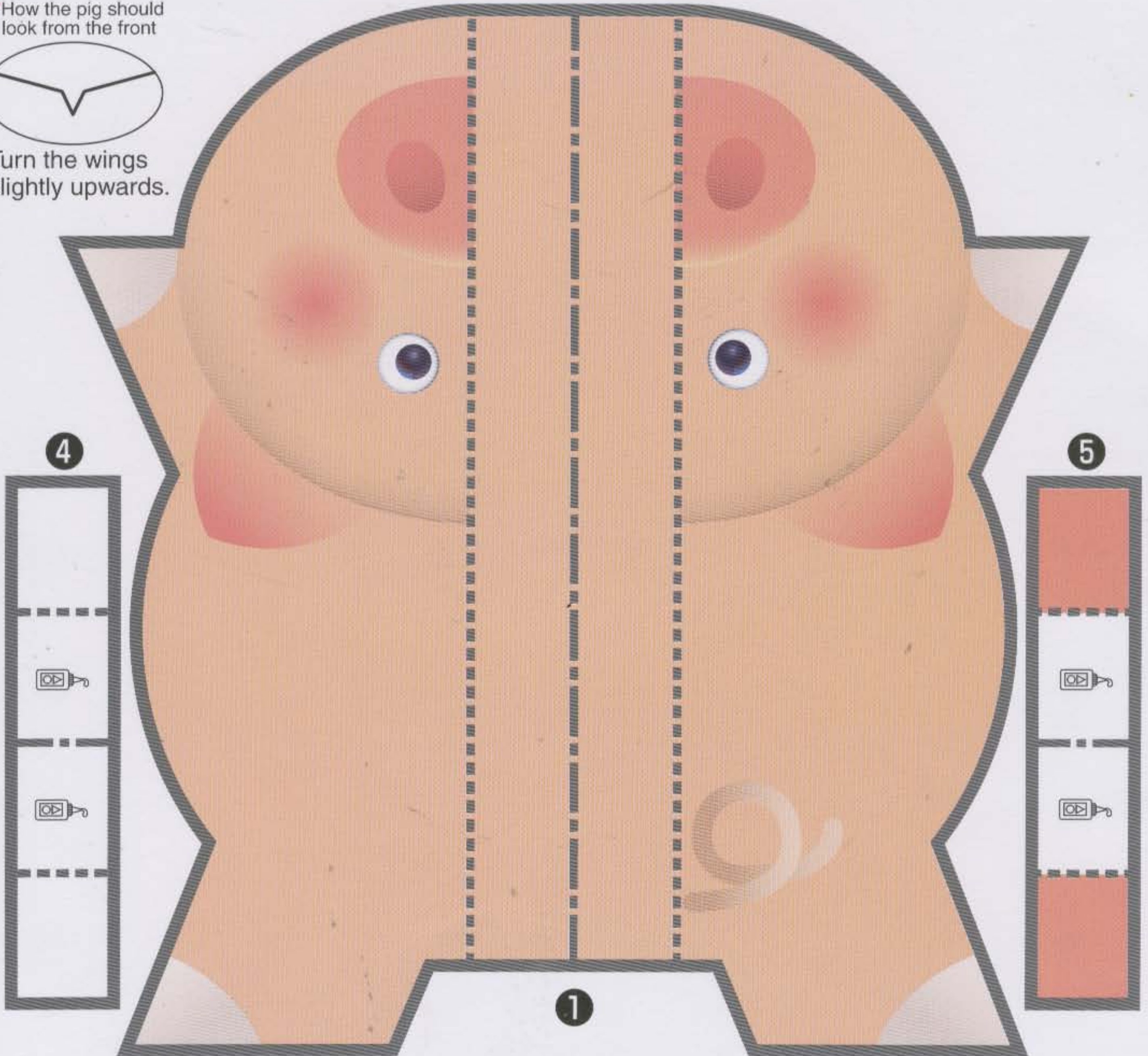

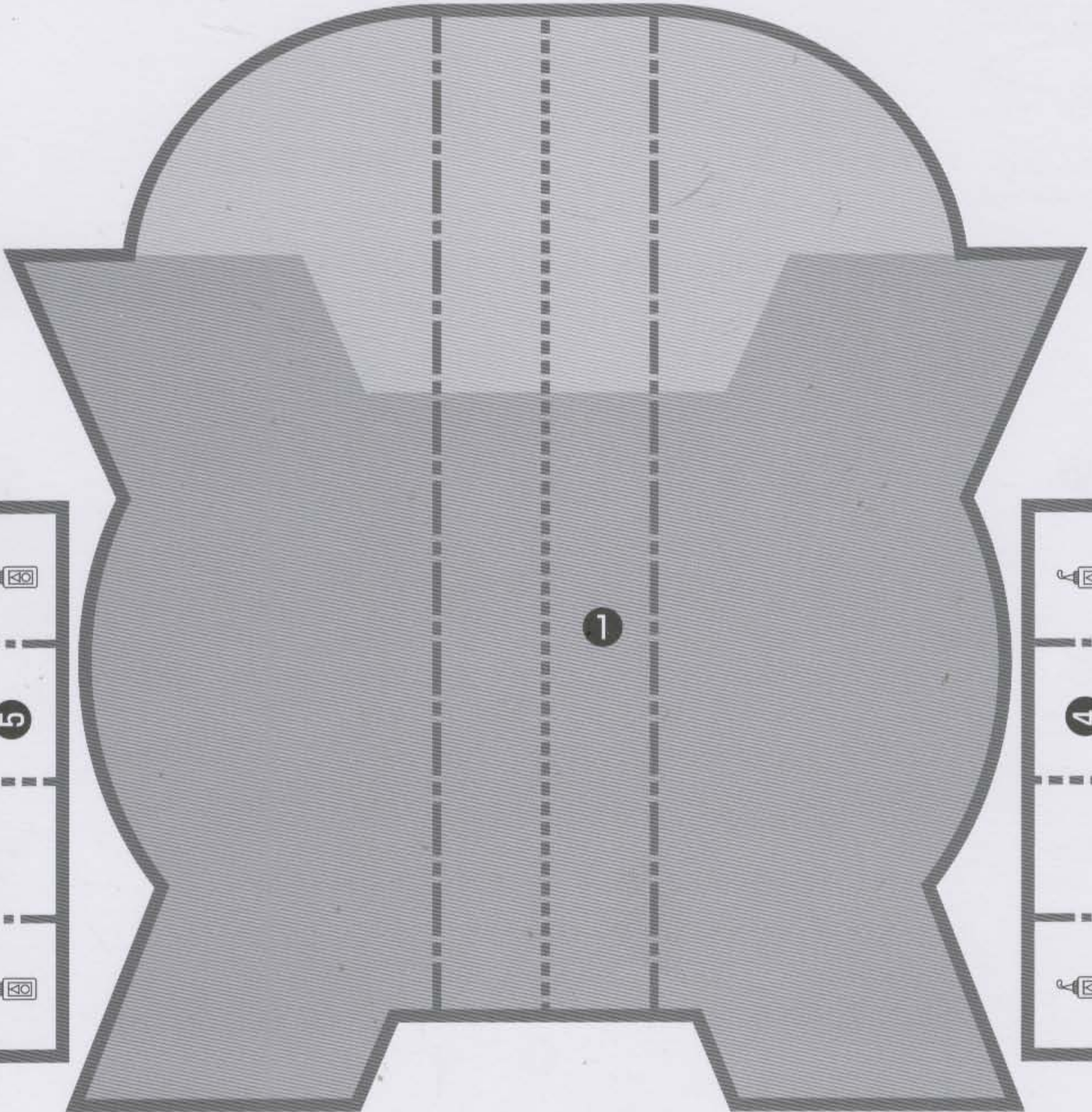
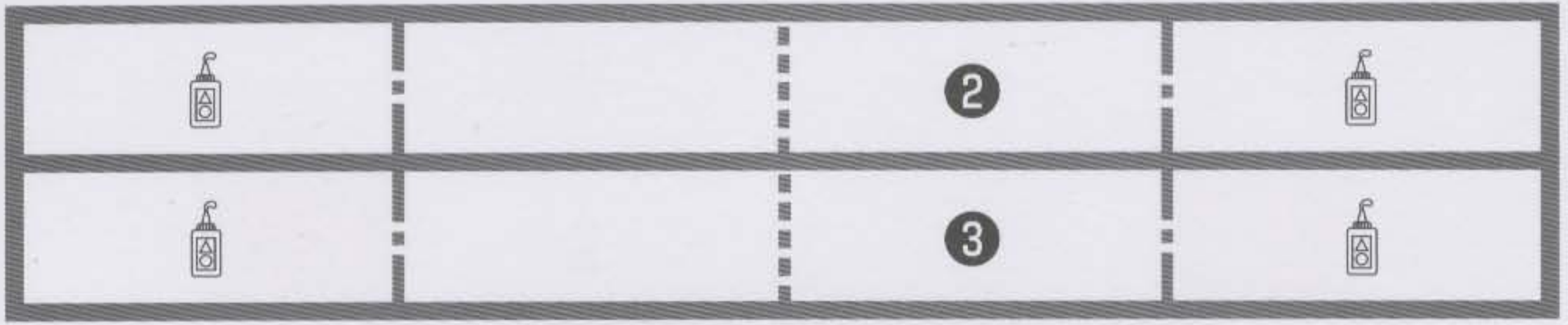

# 14

## Flying Hippo

**HOW TO PLAY**

Fly the hippo gently. Do not throw it too hard.

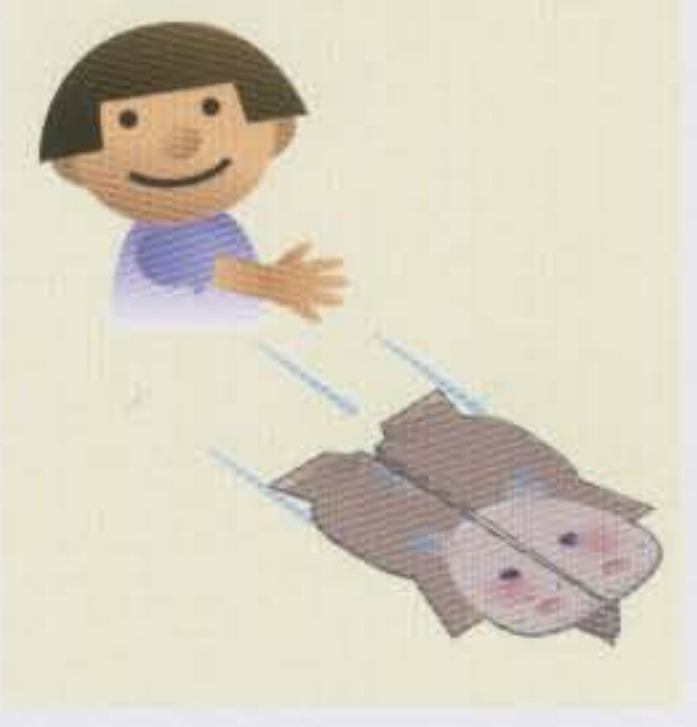

1. Cut along the thick lines .
2. Fold each part downwards along the dotted lines and upwards along the dashed lines . Paste the backs of ②, ③, ④, and ⑤ as shown below.
3. Paste ②, ③, ④, and ⑤ together and attach onto the tip of ①.

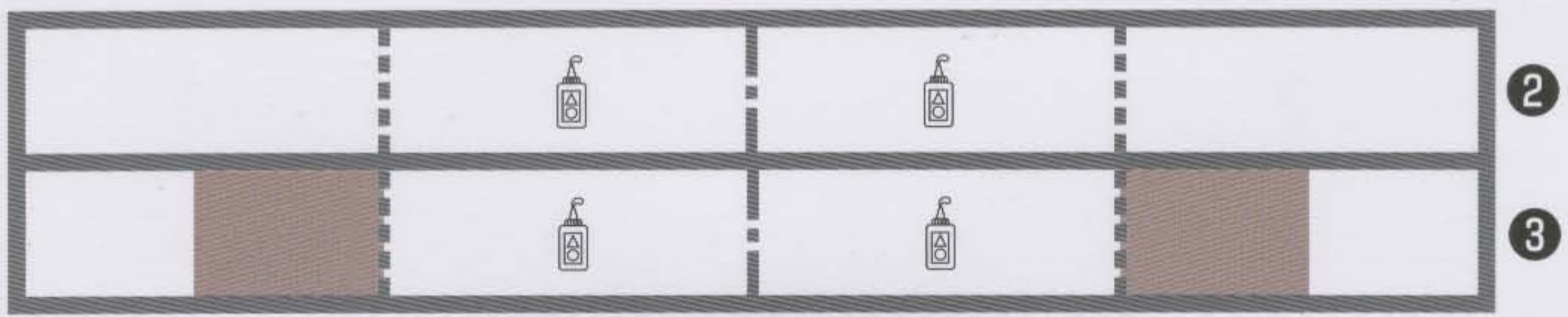
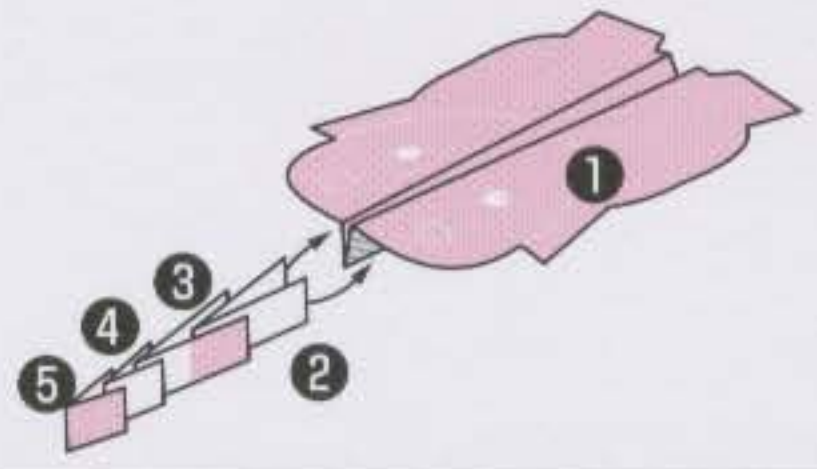
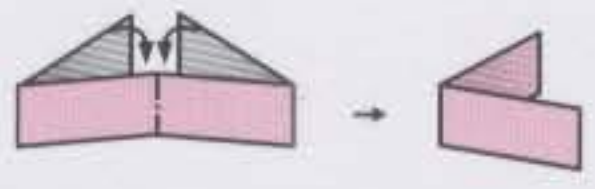

▼ How the hippo should look from the front



Turn the wings slightly upwards.

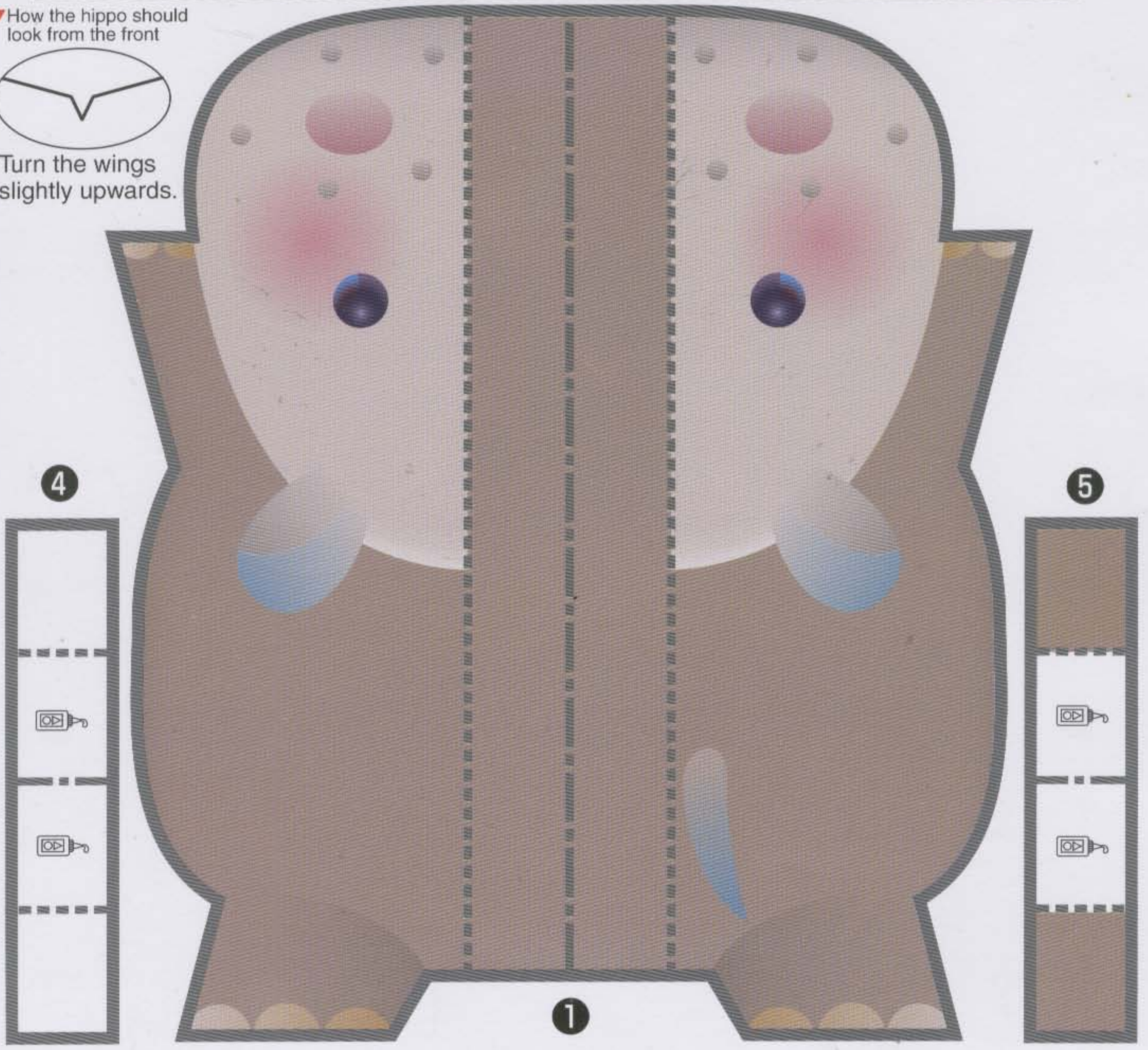

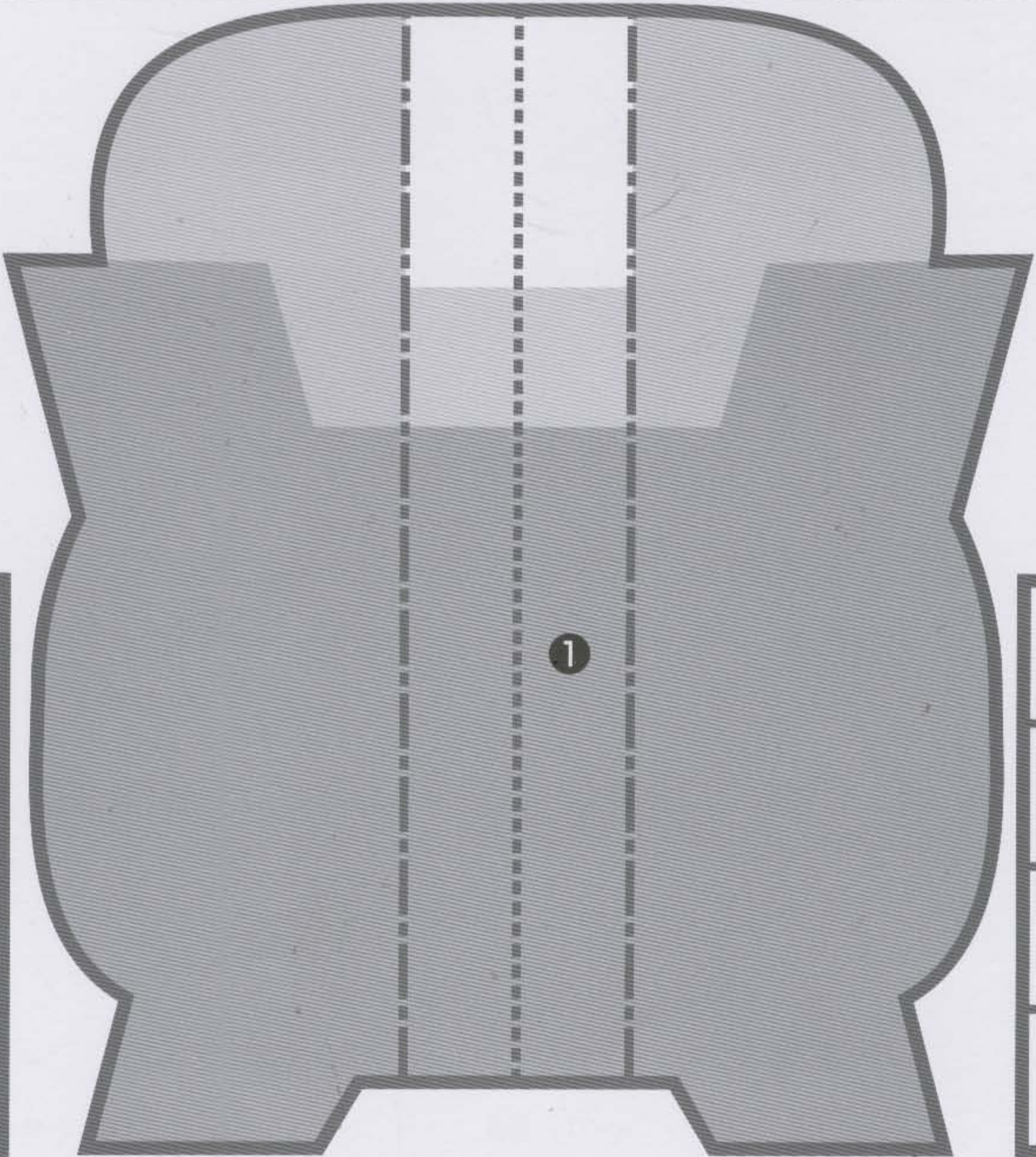
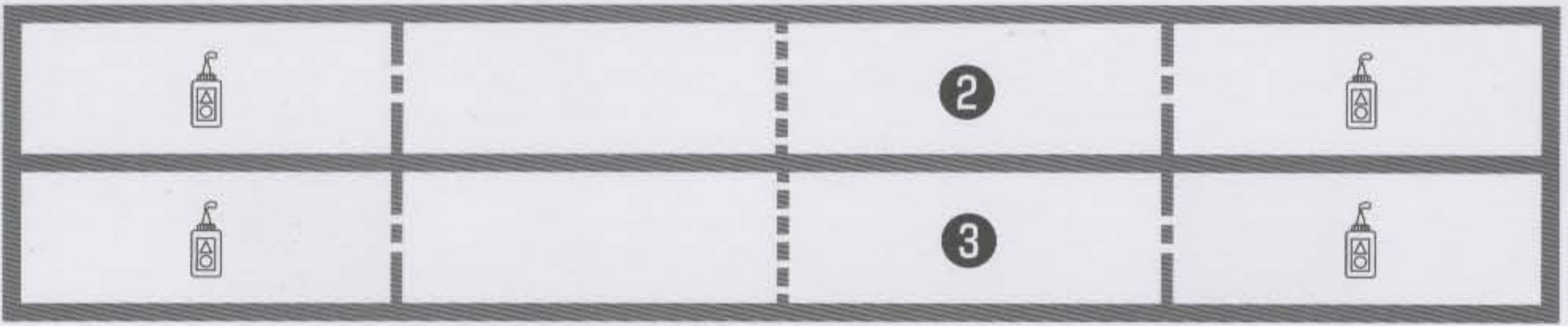

\*Parents, please cut along this line for your child.



# 15

## Spinning Alien

1. Cut along the thick lines .
2. Fold downwards along the long dotted line  and upwards along the dashed lines . Fold up the flaps at the bottom and paste them into place.

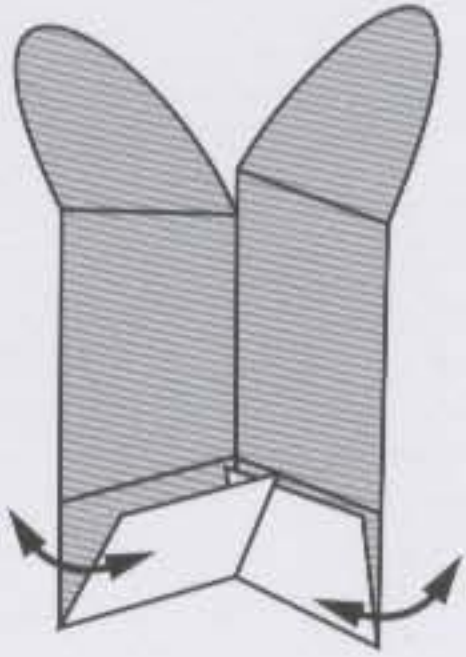

3. Paste the two halves together according to the glue marks.

Do not paste the top parts.

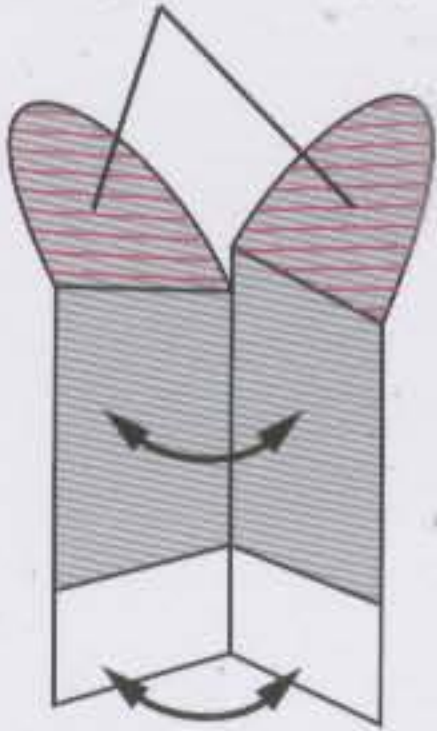

### HOW TO PLAY



Toss it up or throw it down.

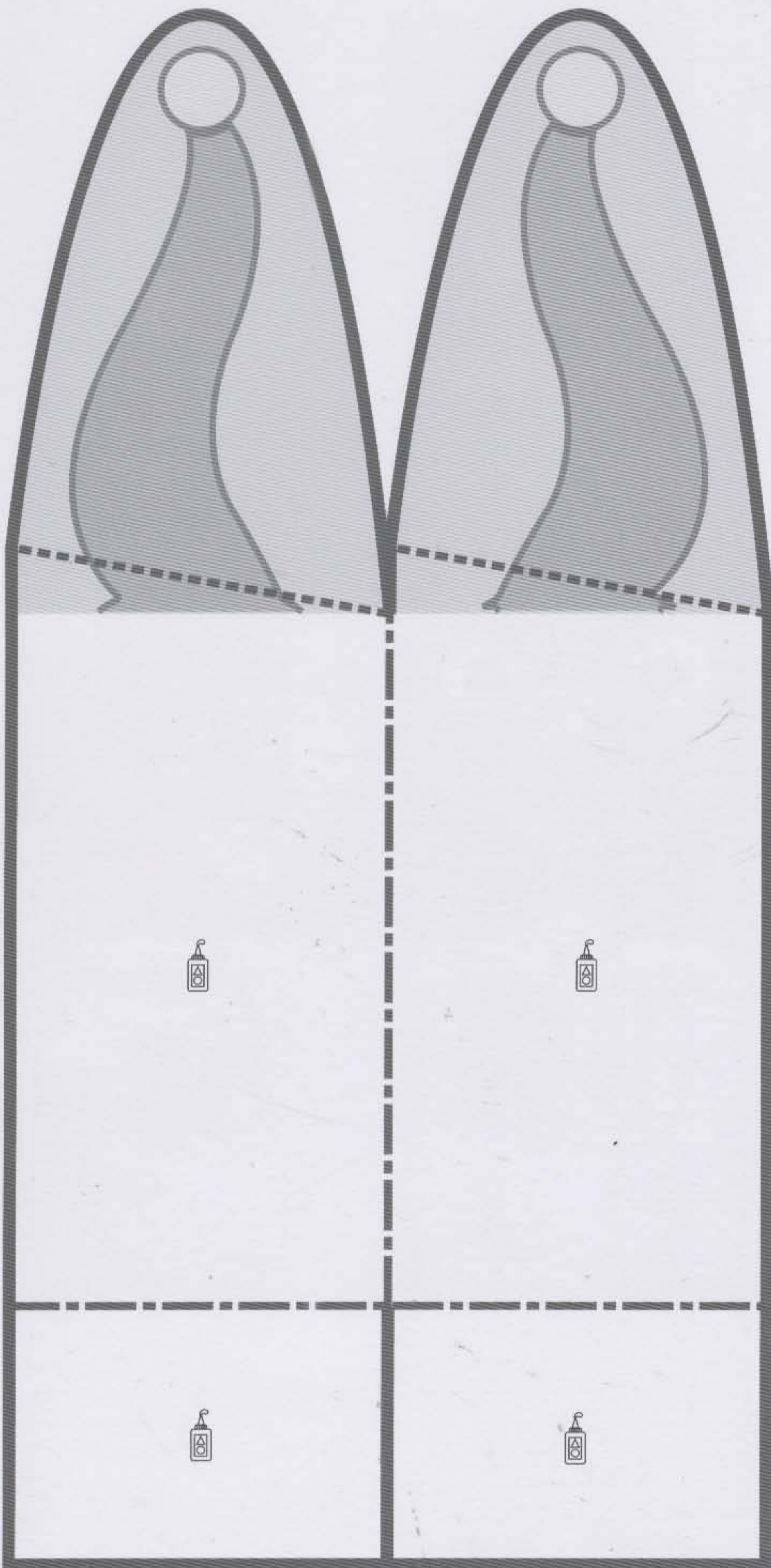





# Spinning Rocket

- 1. Cut along the thick lines .
- 2. Fold upwards along the dashed lines .

- 3. Curl the rocket into a cone shape. Make a knot at the end of a string and place it inside the rocket. Paste the tab onto the back of the other edge to complete the cone with the string inside.

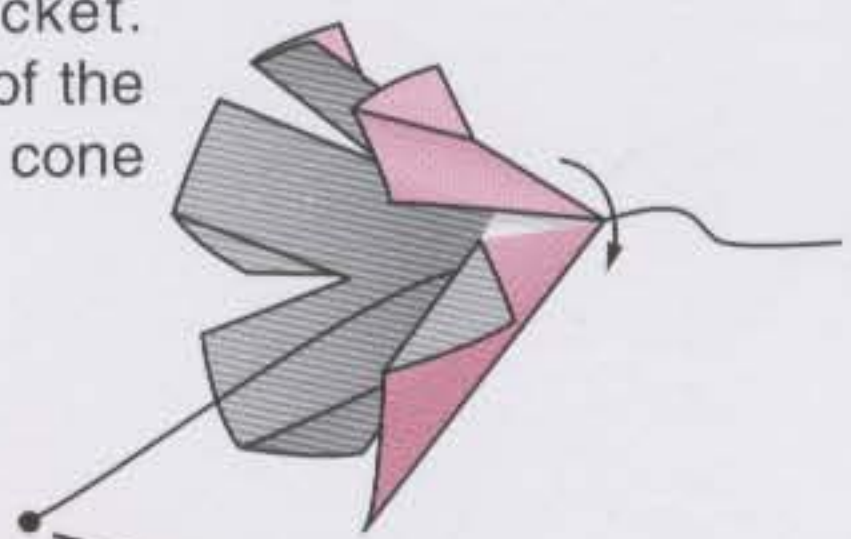
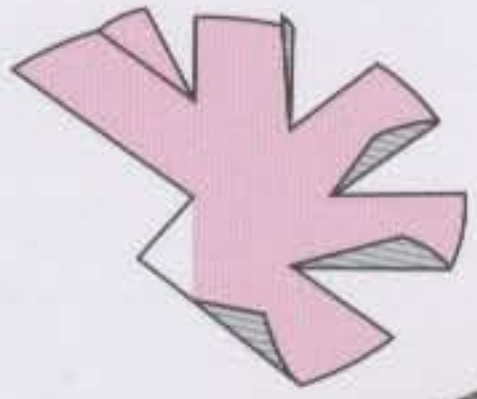

Make a knot at the end of a string.

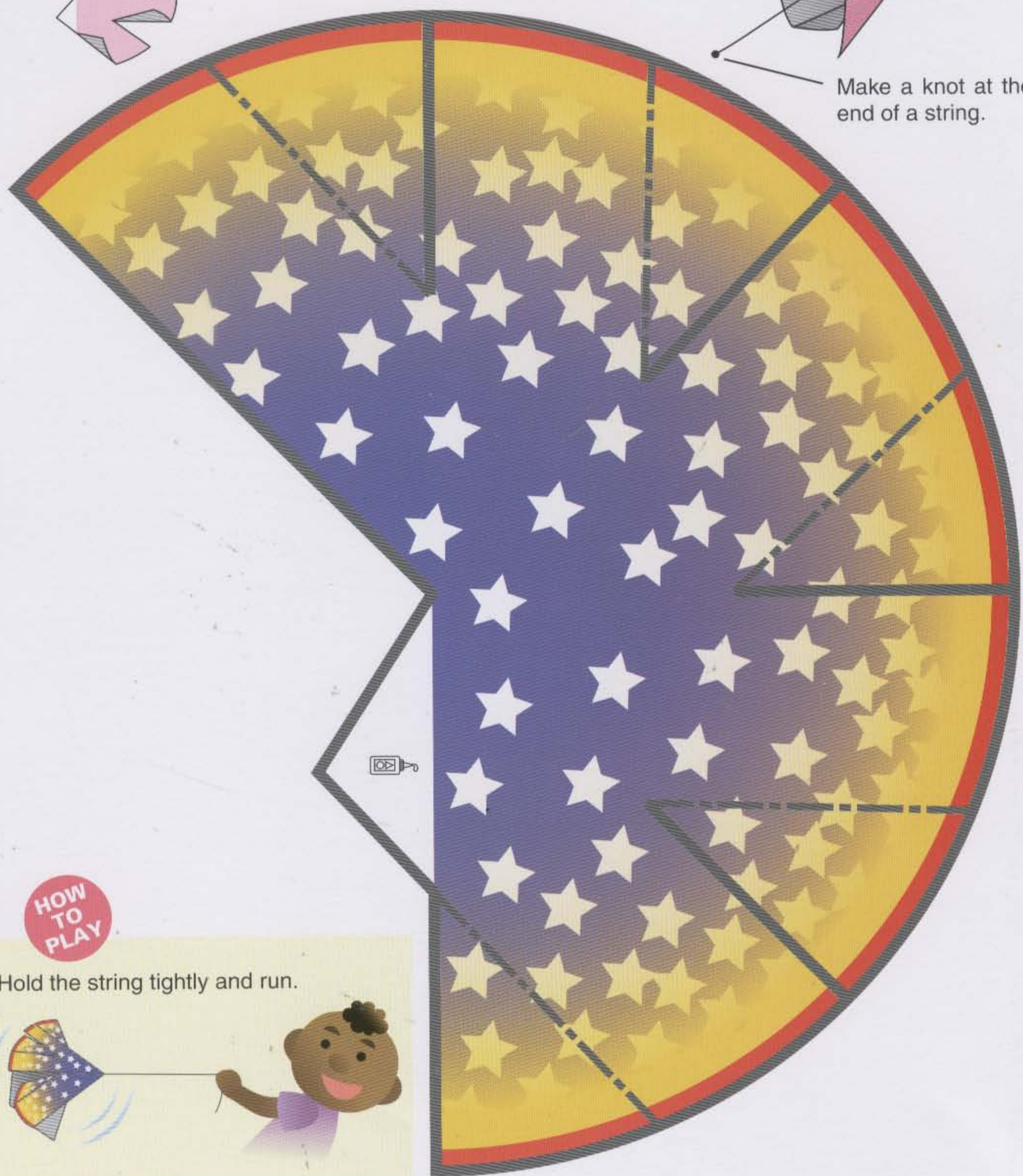

**HOW TO PLAY**

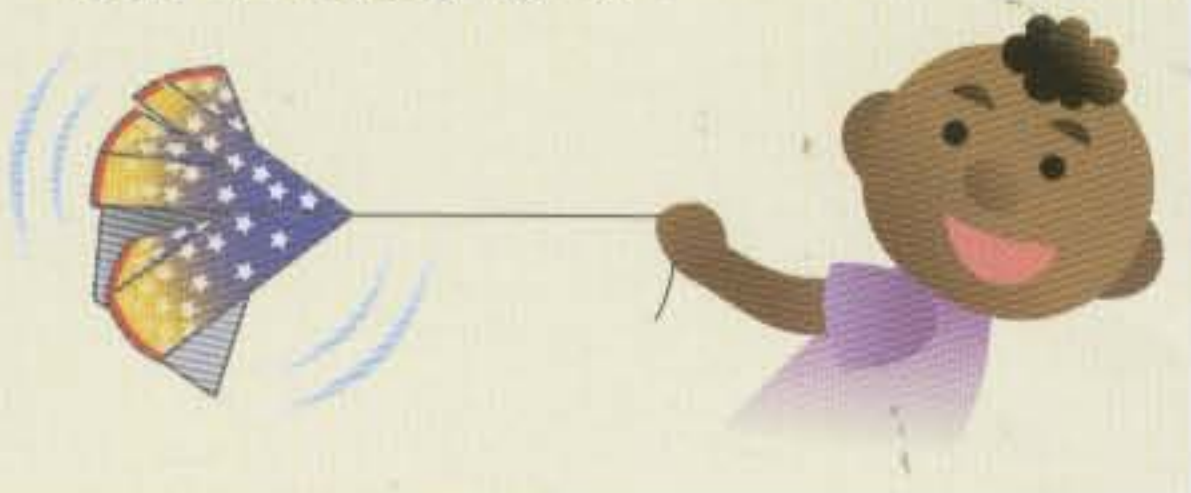

Hold the string tightly and run.

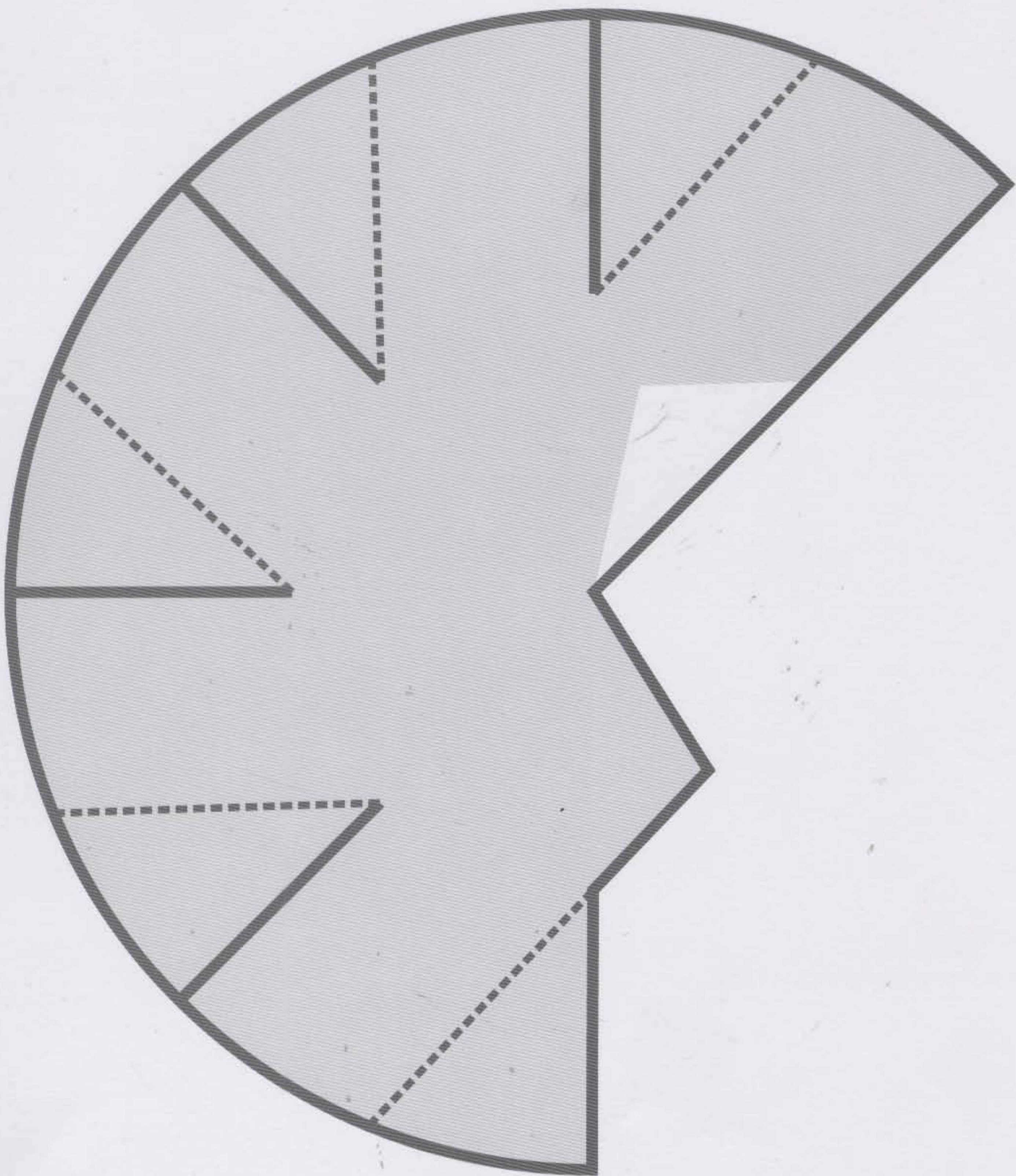

\*Parents, please cut along this line for your child.



## Rocking Bear

1. Cut along the thick lines .
2. Fold **1** upwards along the dashed lines . Curl it into a ring and paste the edges. Please do not forget to curl the bottom of the bear as well.

3. Fold the edge of **2** and roll it tightly into a stick. Paste the edge. This is a weight.
4. Attach the weight onto the bottom of **1**.

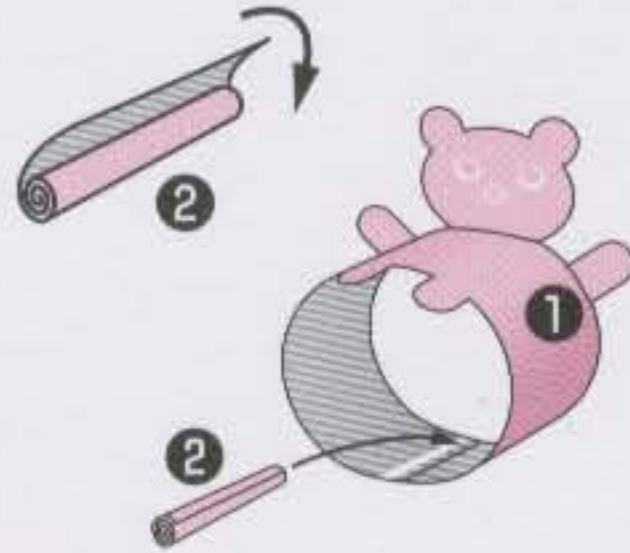

2

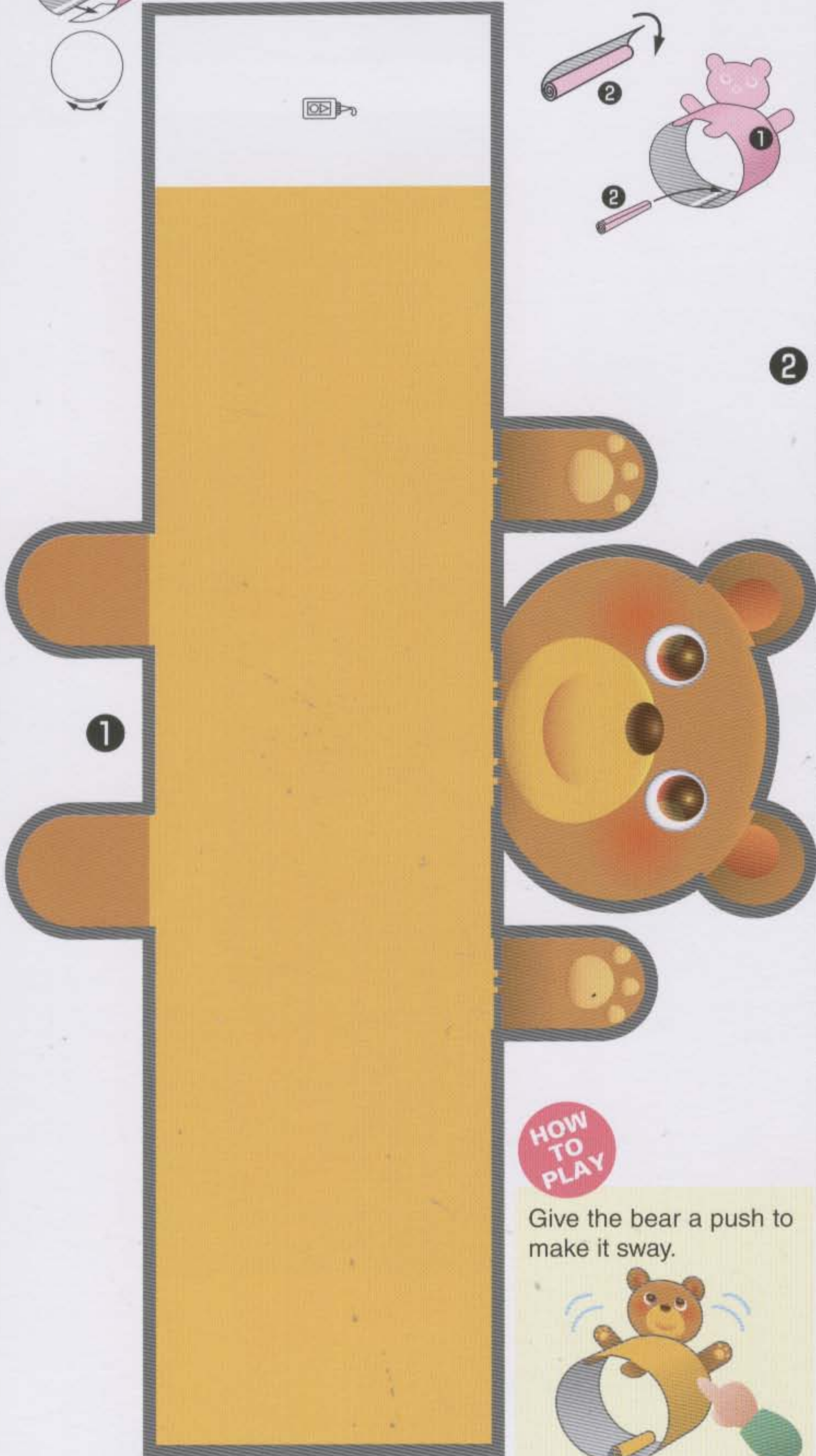



HOW TO PLAY

Give the bear a push to make it sway.

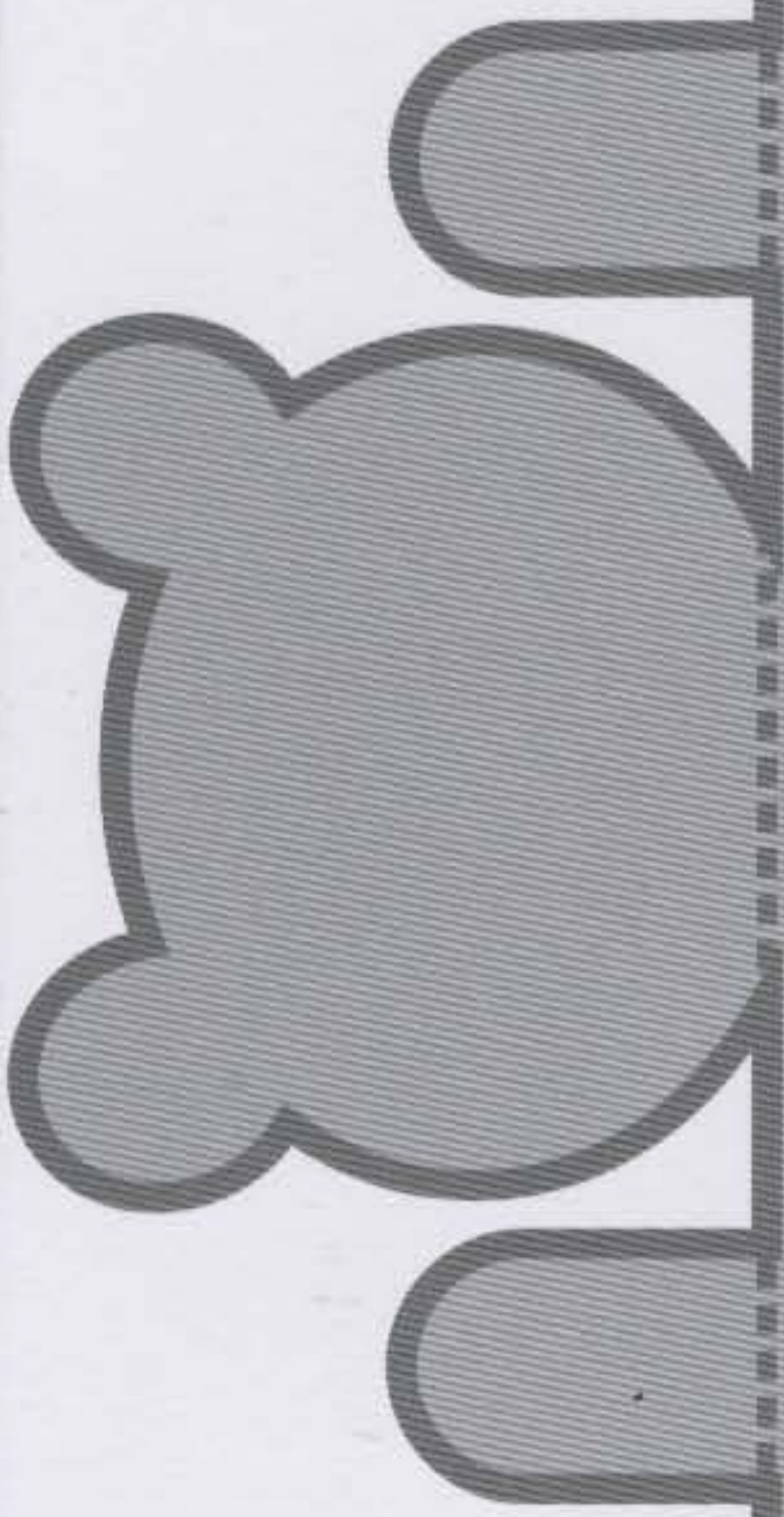
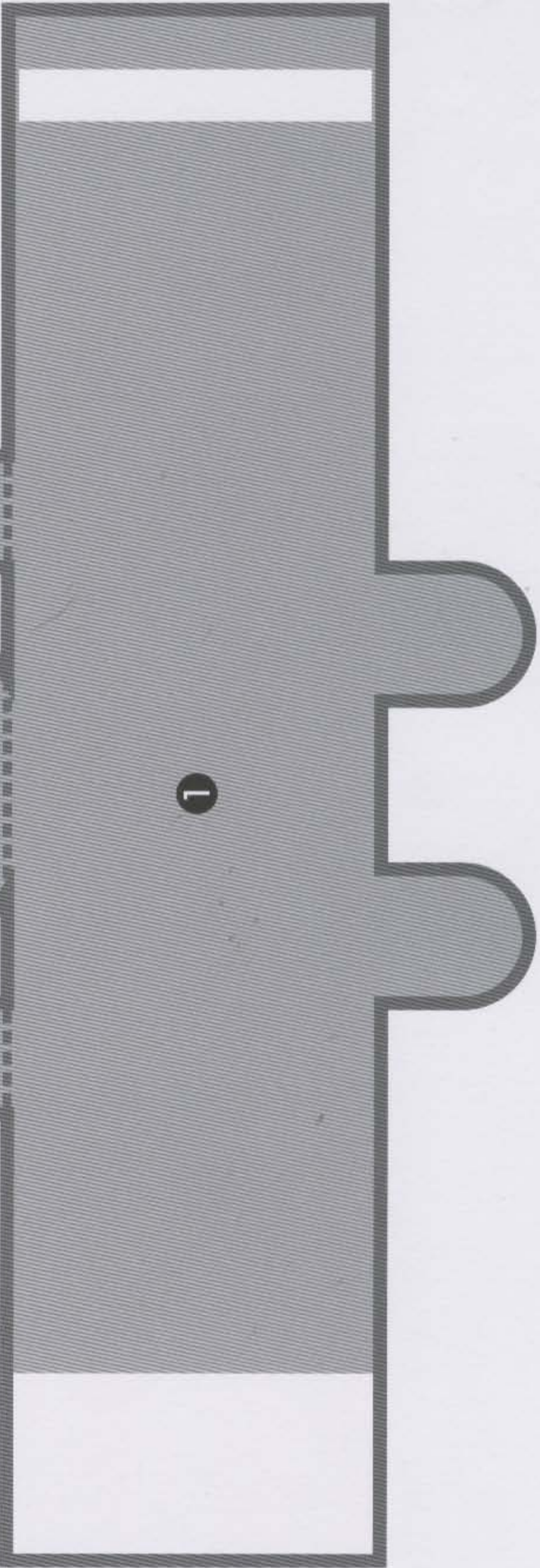

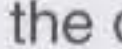

## Bobble Head Doggie

1. Cut along the thick lines .
2. Fold downwards along the dotted line  and upwards along the dashed line .
3. Curl **1** into a cone shape. Paste the tab onto the back of the other edge.
4. Paste the tab of **2** to the back of the adjacent edge. Place **2** on top of **1**.

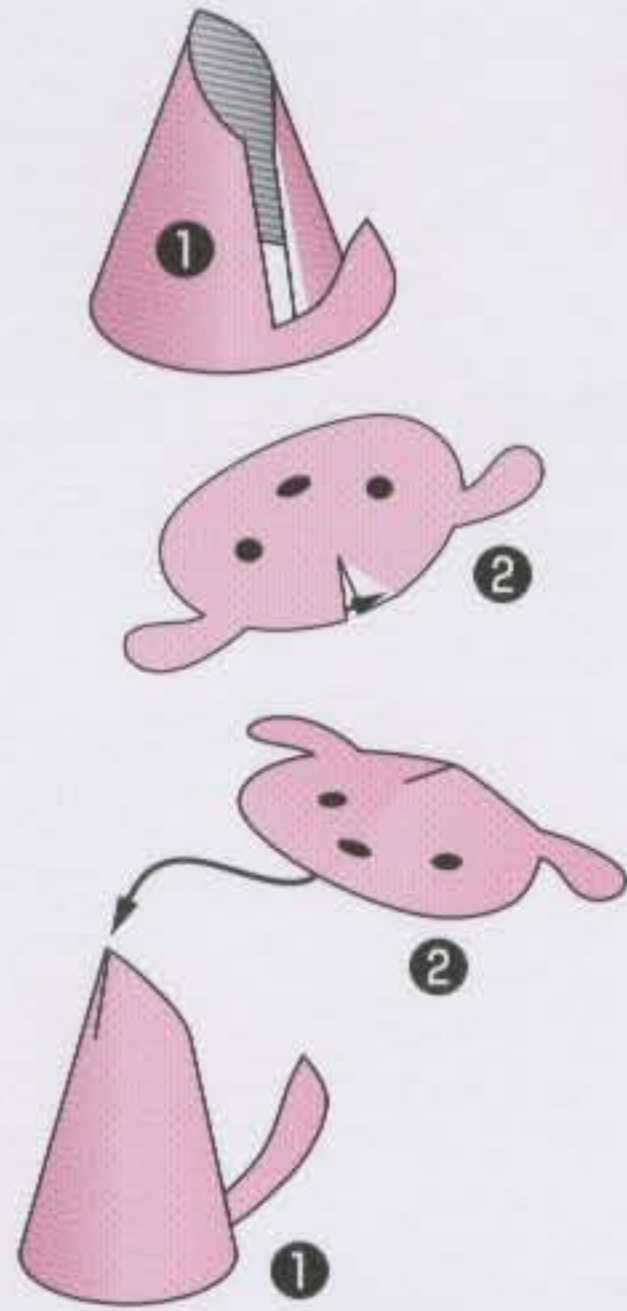

**HOW TO PLAY**

Poke the dog's head with your finger. The dog will bob its head.

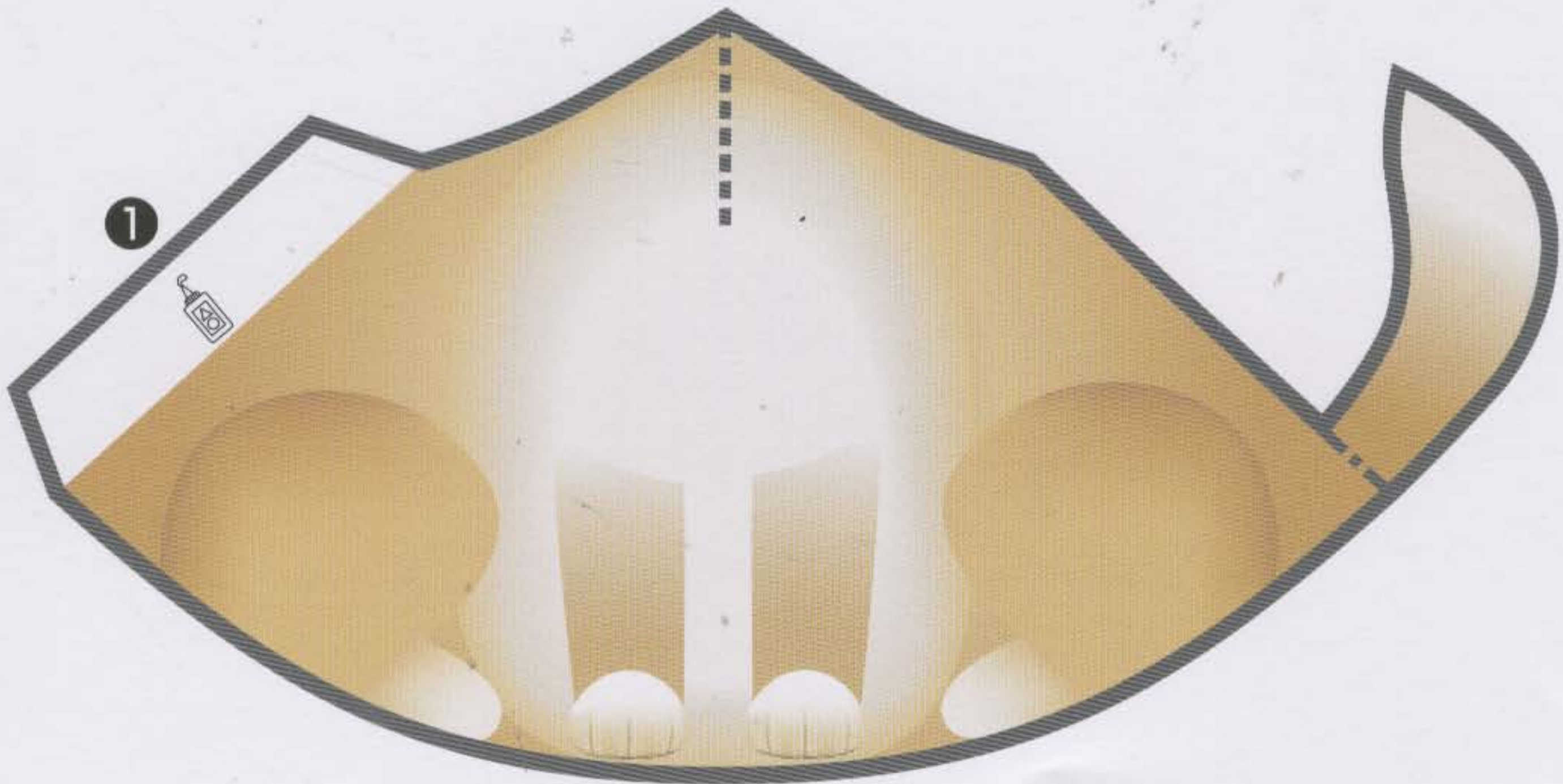

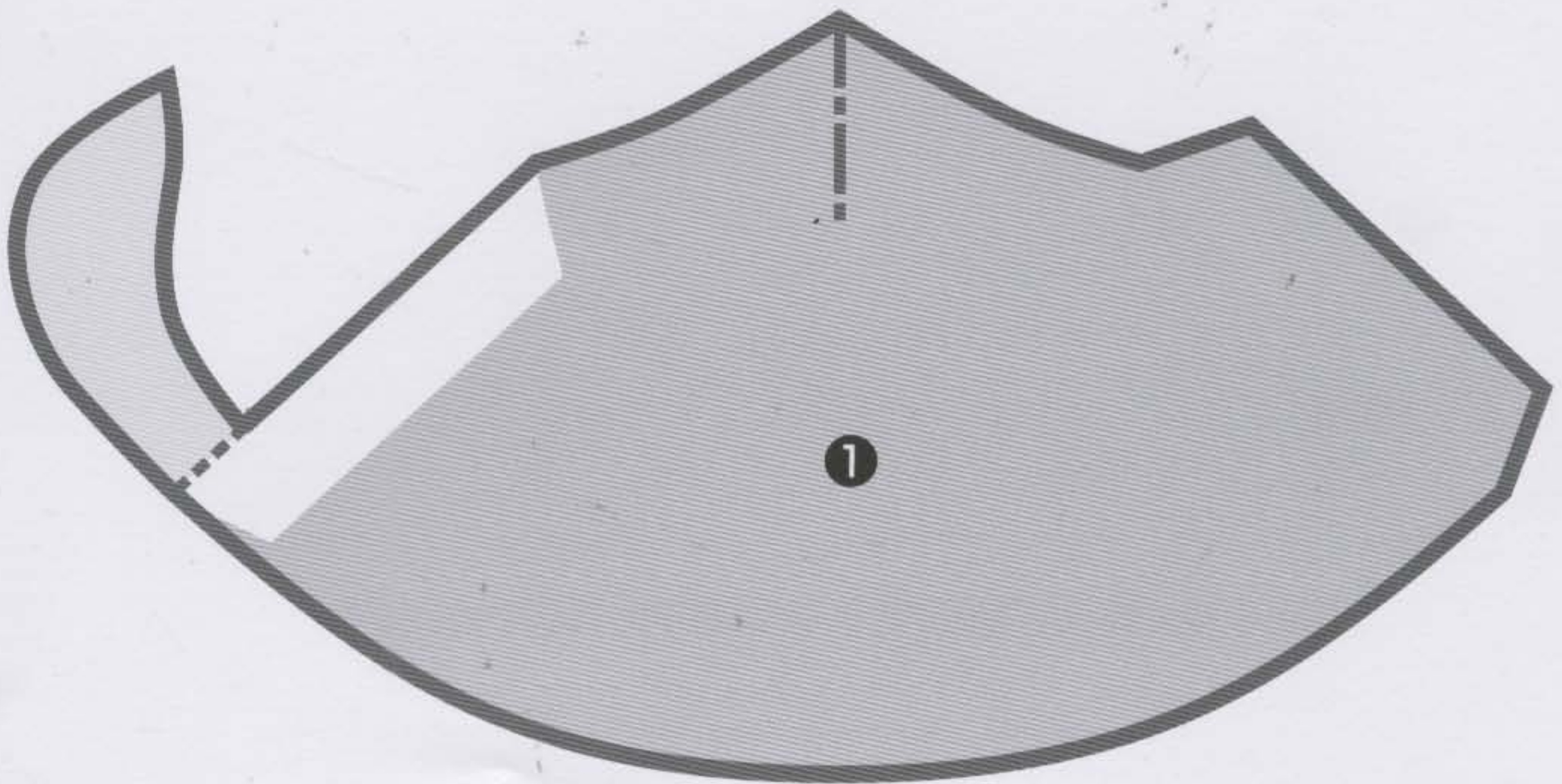
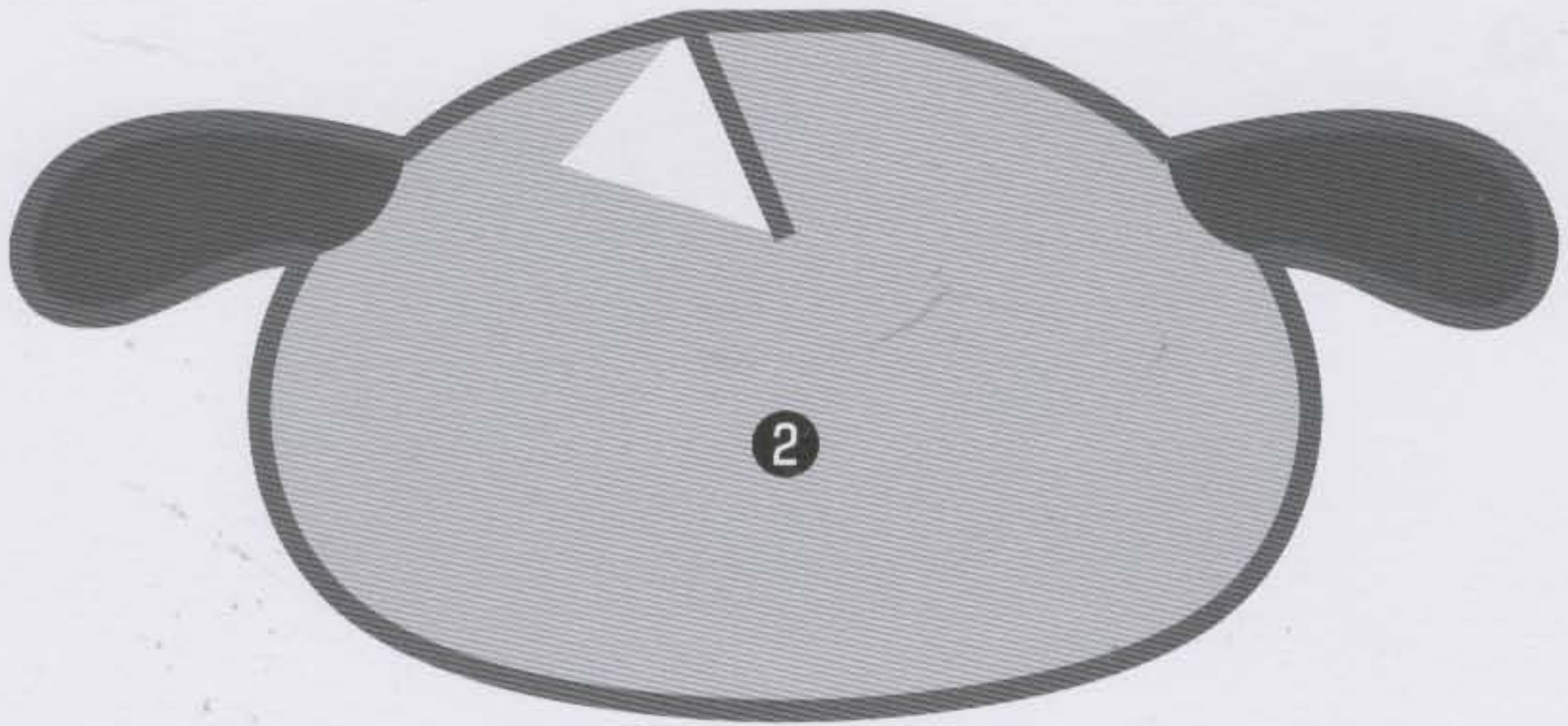

## Fishing

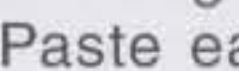
1. Cut along the thick lines .
2. Fold each fish downwards along the dotted lines . Paste each tab onto the back of the adjacent edge.
3. Fold the hooks in half and paste the insides. Tie a piece of string to each hook.

fish

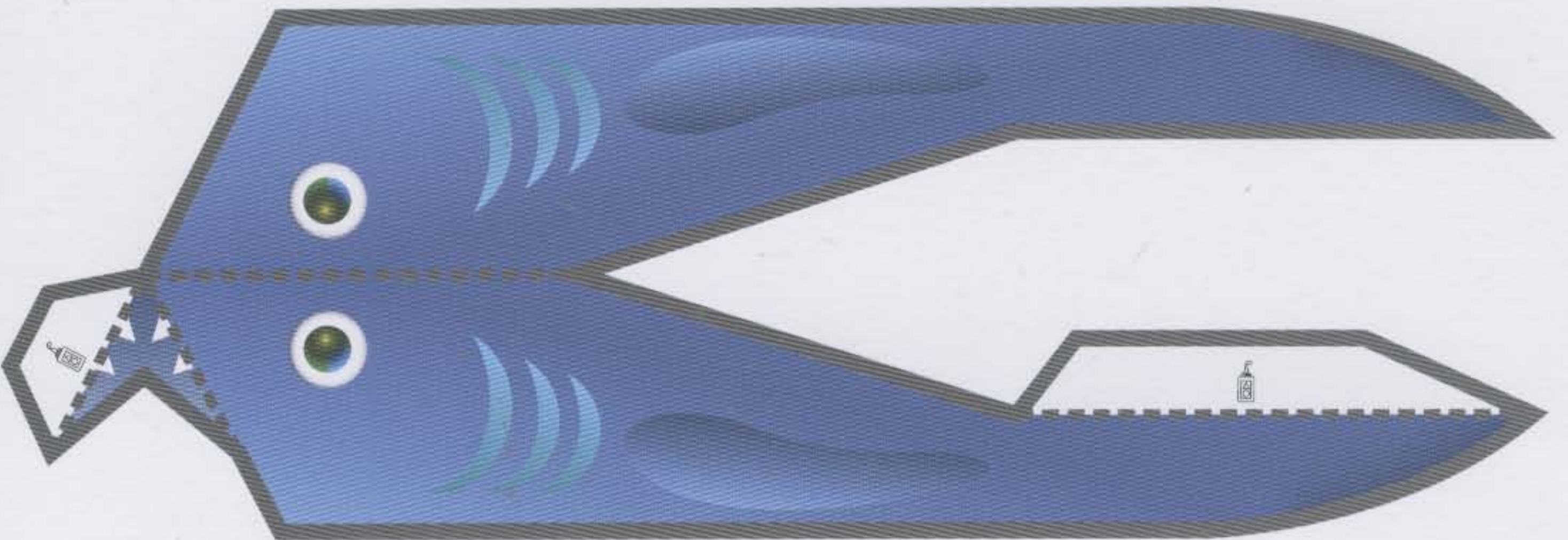
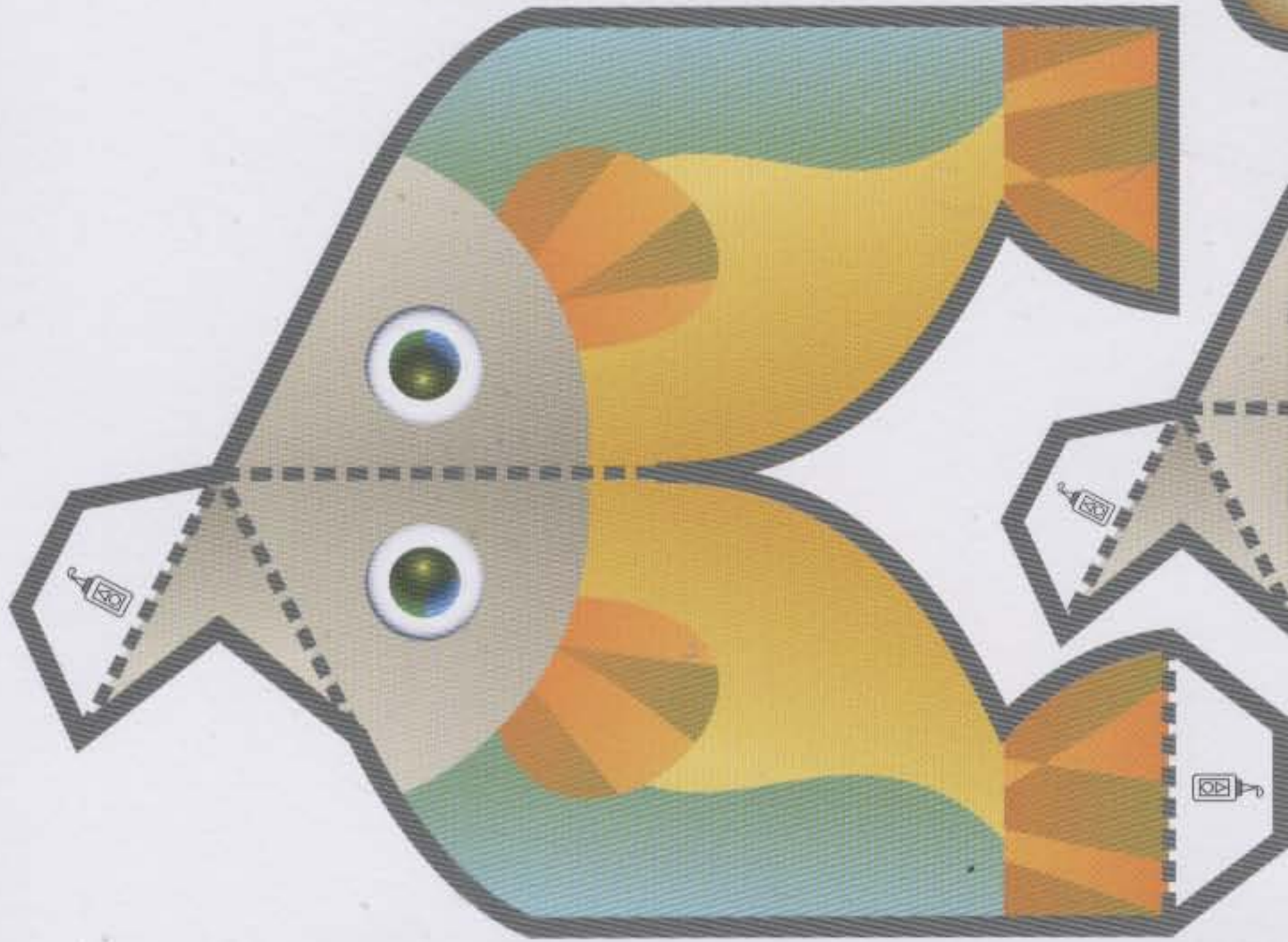
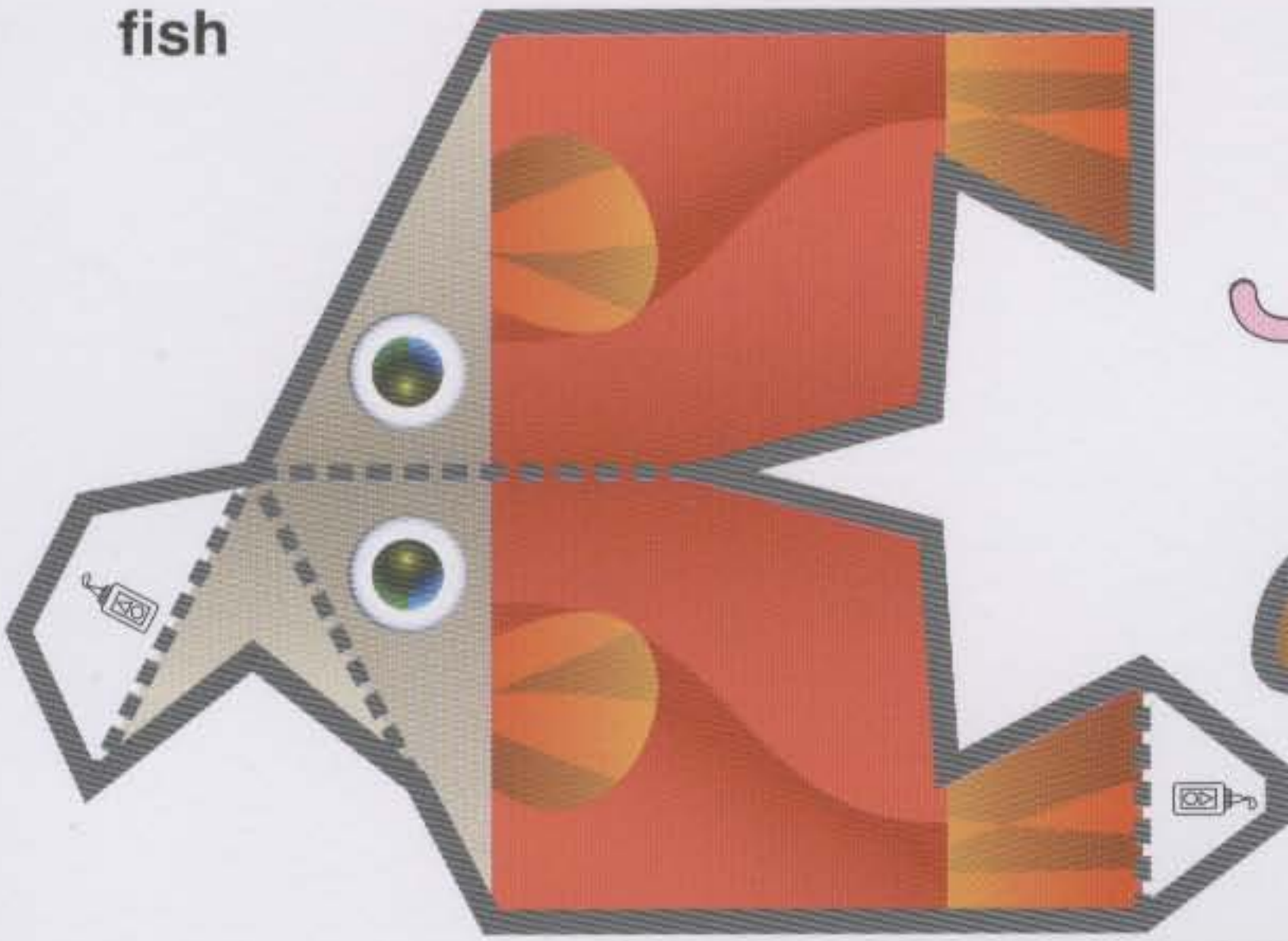

hooks

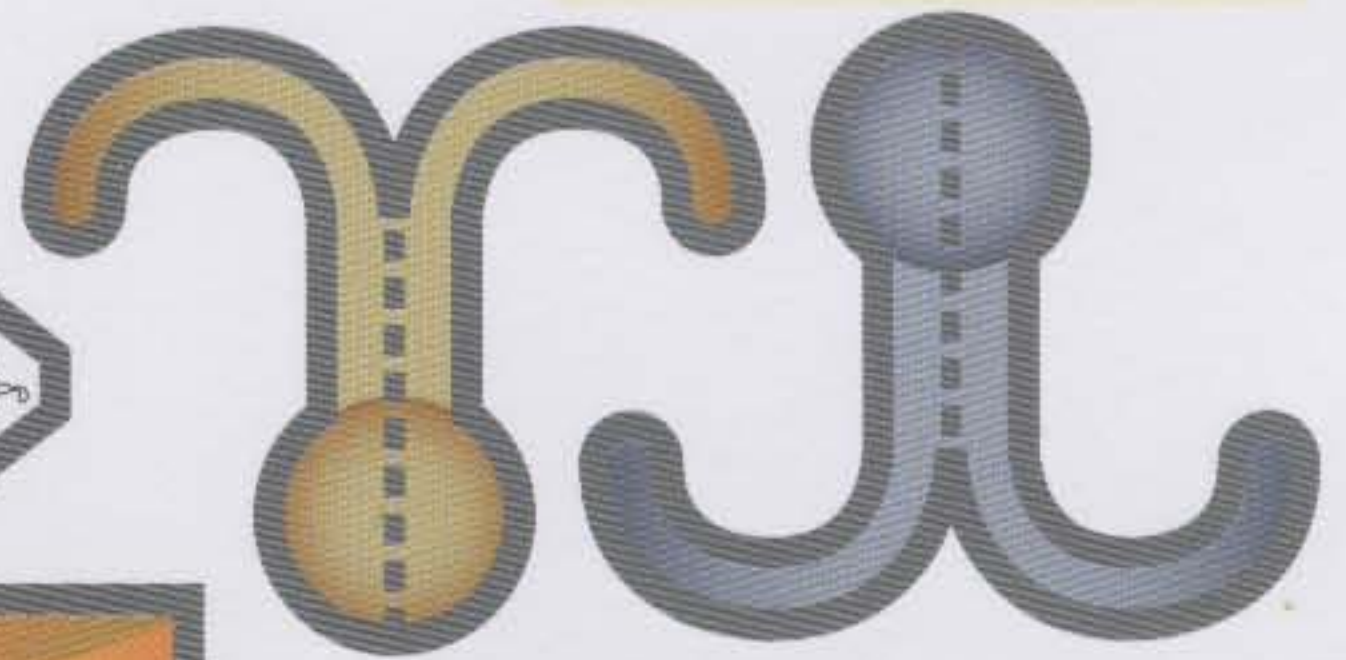

**HOW TO PLAY**

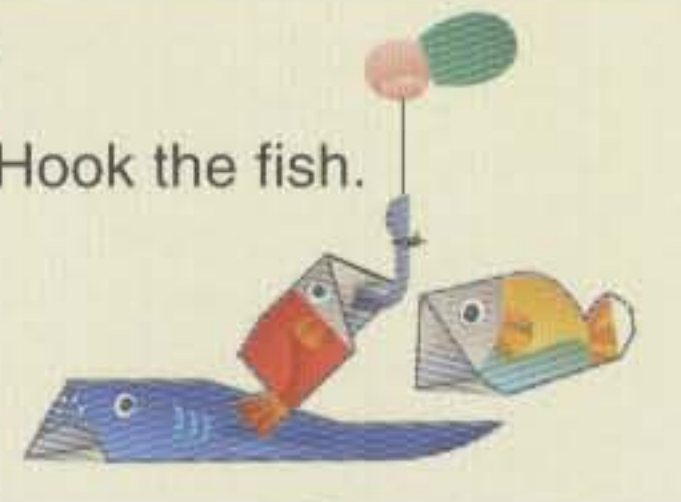

Hook the fish.

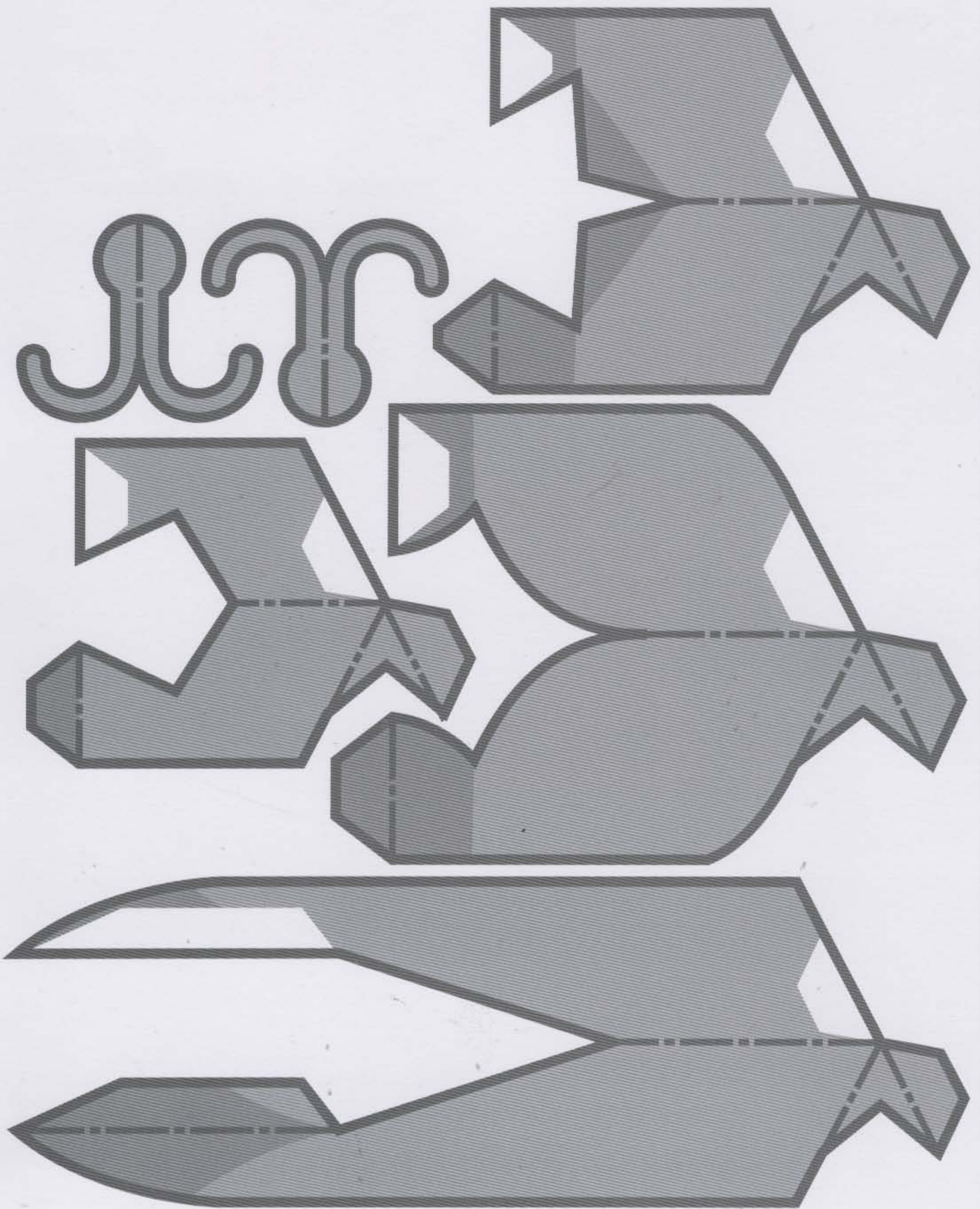





## Walking Rabbit

1. Cut along the thick lines .
2. Fold ① downwards along the dotted lines  and upwards along the dashed lines . Curl it into a ring. Paste the long tab onto the back of the other edge.
3. Attach ② to ①.

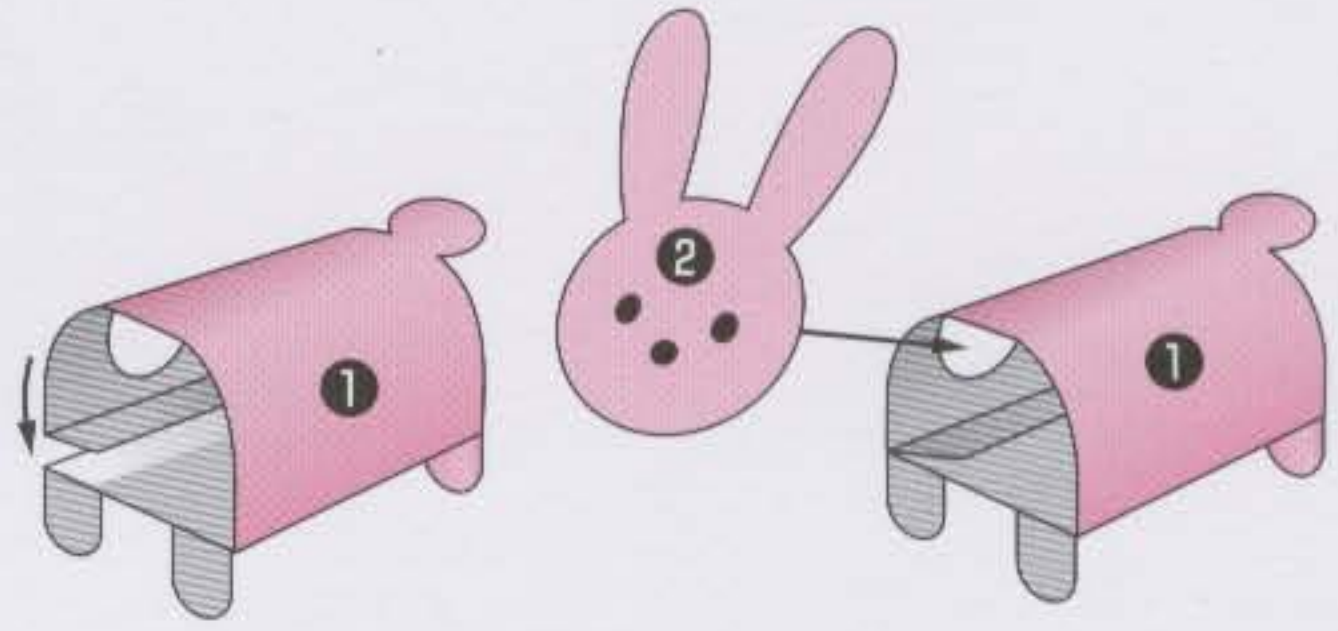

**HOW TO PLAY**

Curl the legs slightly backwards and place the rabbit on a box. Knock the box's surface to make the rabbit walk.

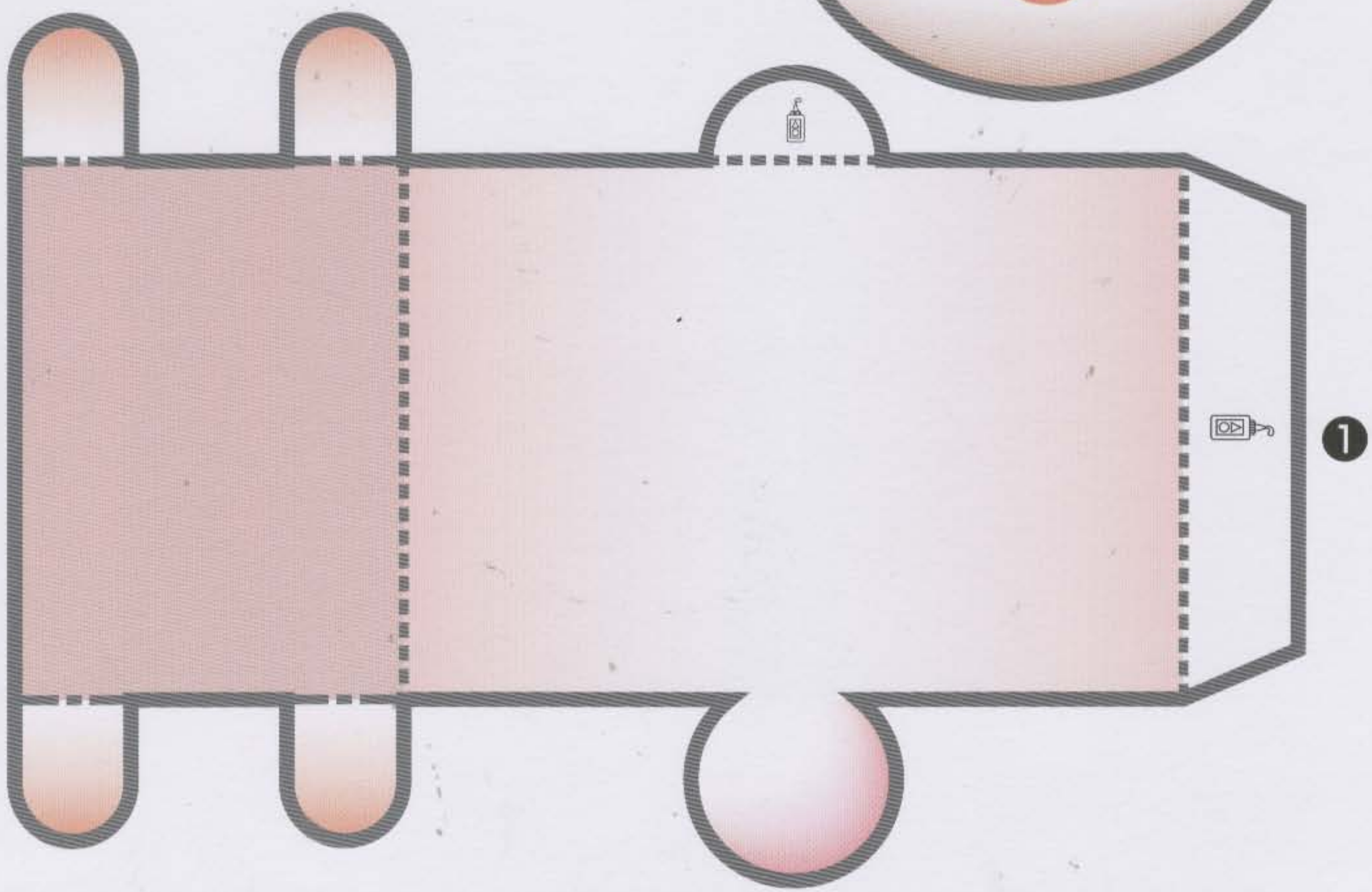

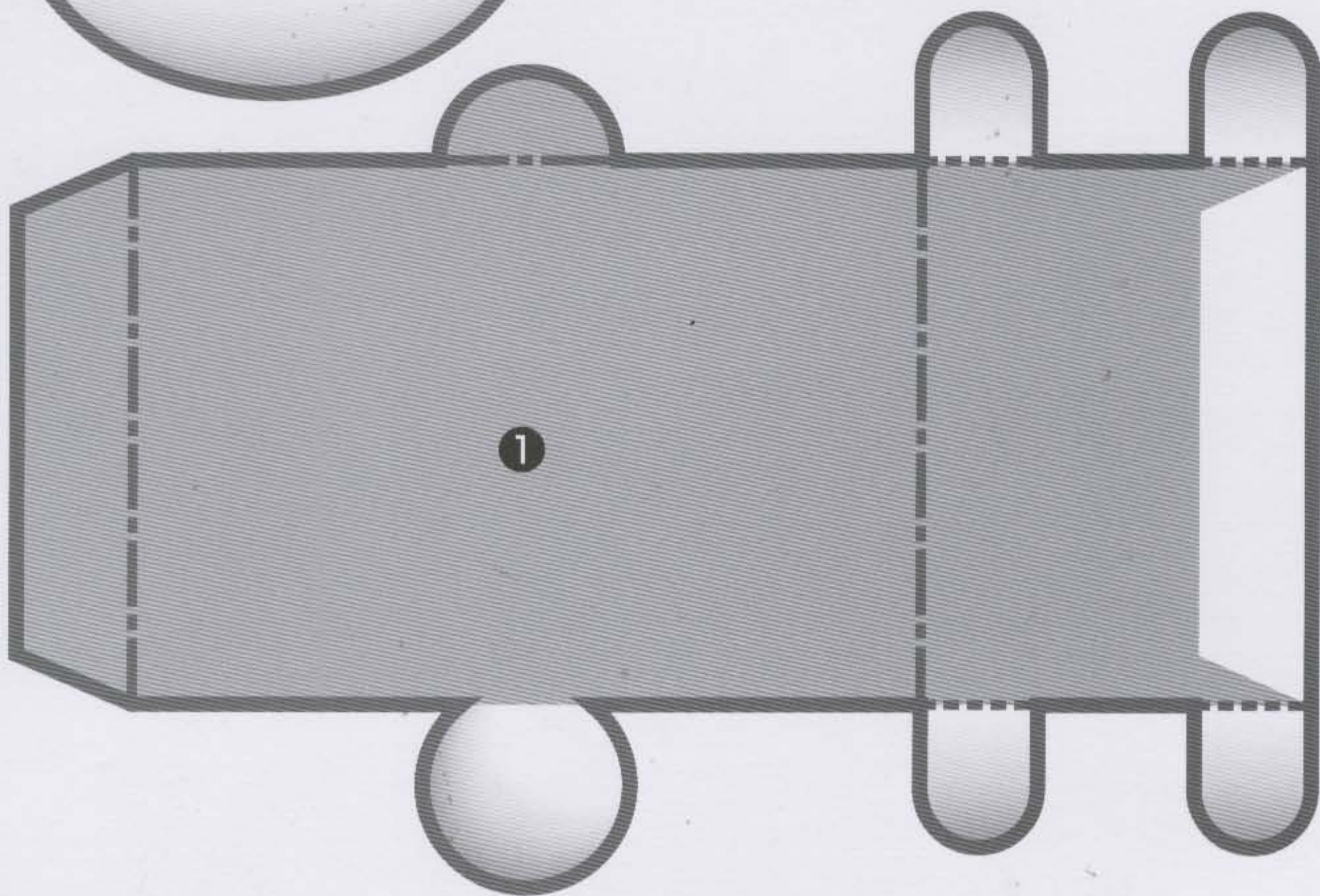
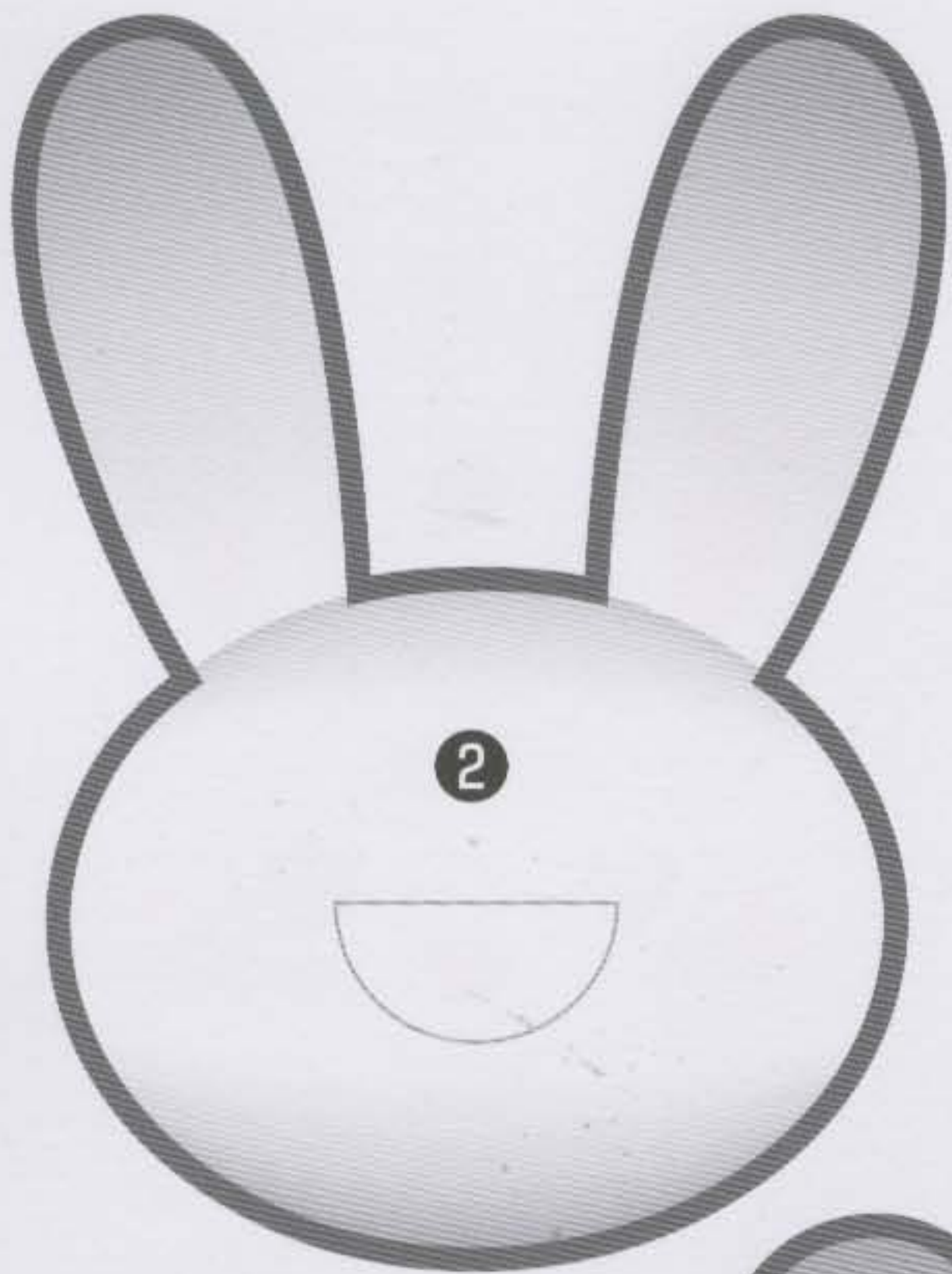

\*Parents, please cut along this line for your child.





# 21

## Skydiving Ninja

1. Cut along the thick lines .

2. Fold **1** in half along the dotted line . Cut along the thick

lines  and unfold. Turn up the flaps.

3. After folding downwards along the dotted lines , paste the tabs of **2** onto the back of **1** as shown below.

4. Paste **3** onto the front of **2** and **4** onto the back of **2**.

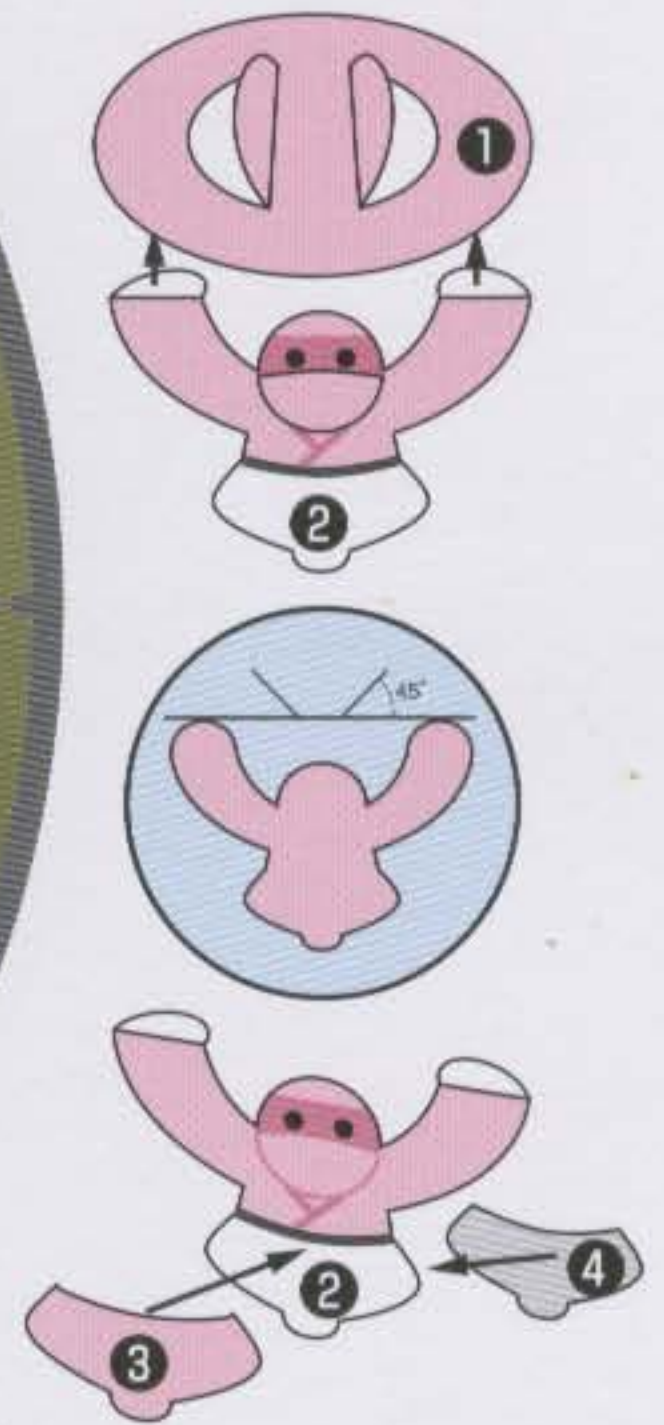
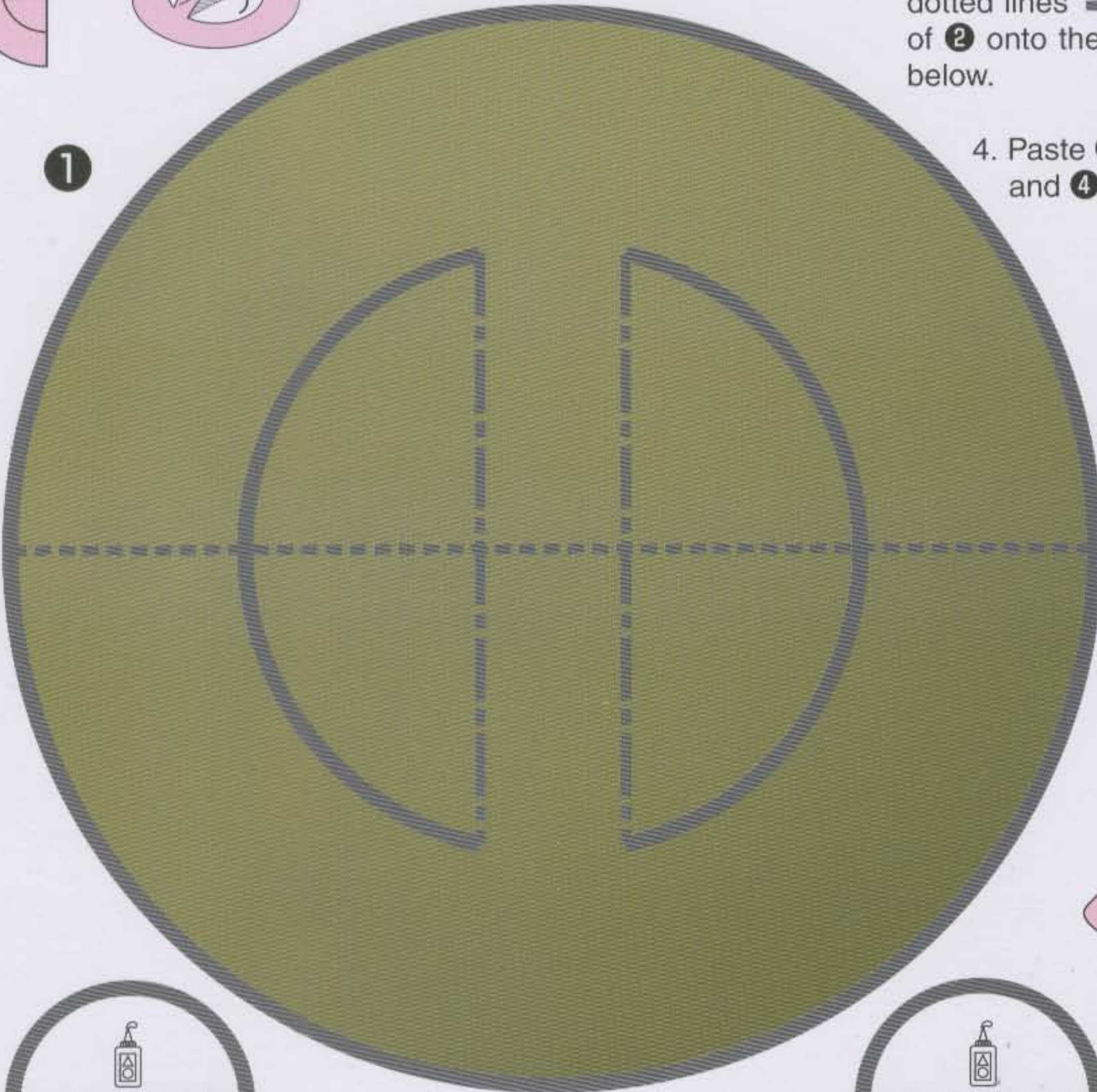

Drop the ninja and watch him float.



HOW TO PLAY



Paste **3** here

\*Parents, please cut along this line for your child.

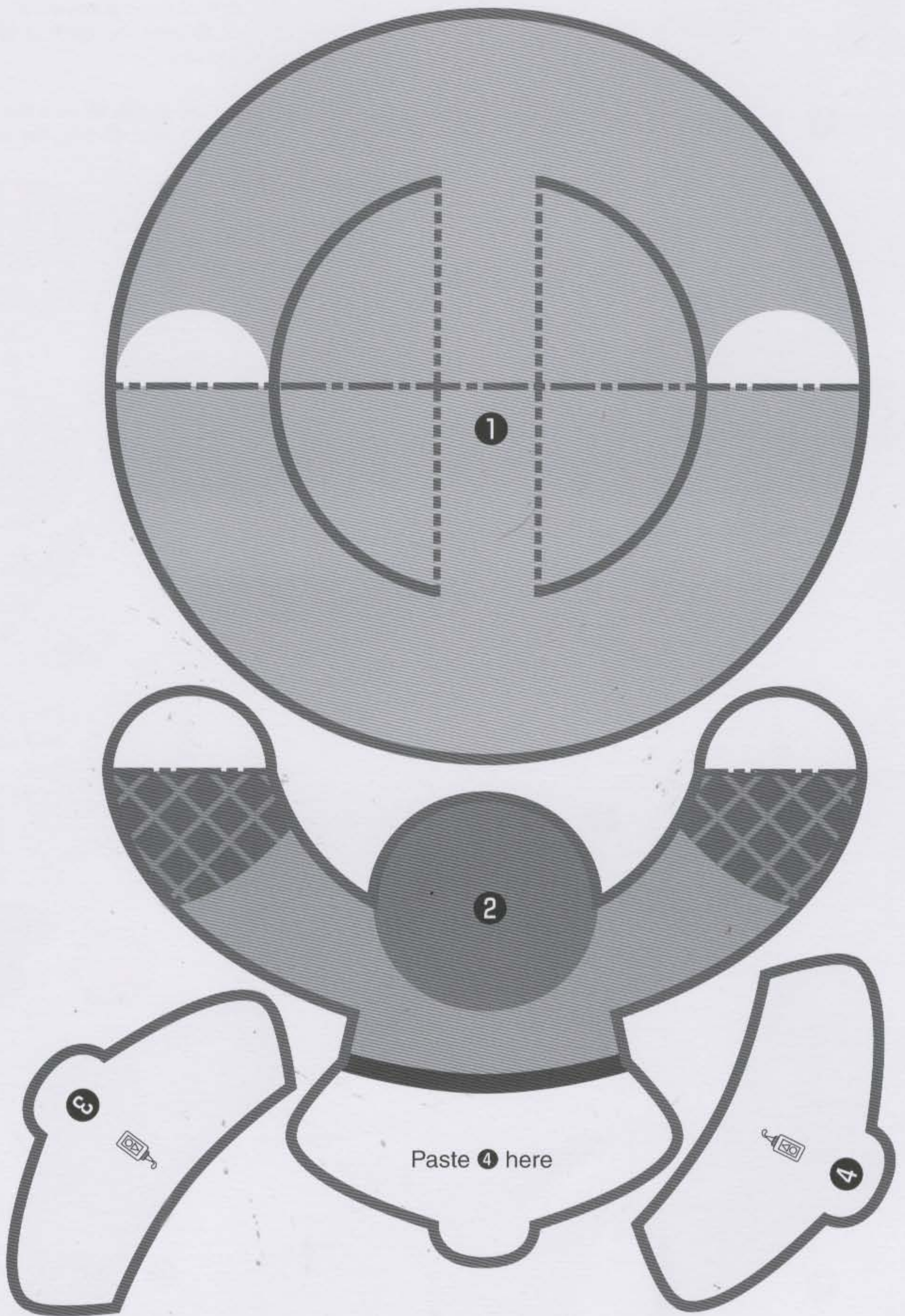

1

2



3

4

Paste 4 here

## Walking Dinosaur

1. Cut along the thick lines .

2. Fold **1** downwards along the long dotted line . Cut out the two holes and unfold. Fold downwards along the other dotted lines .

3. Paste **1**, **2**, **3**, and **4** together as shown below.

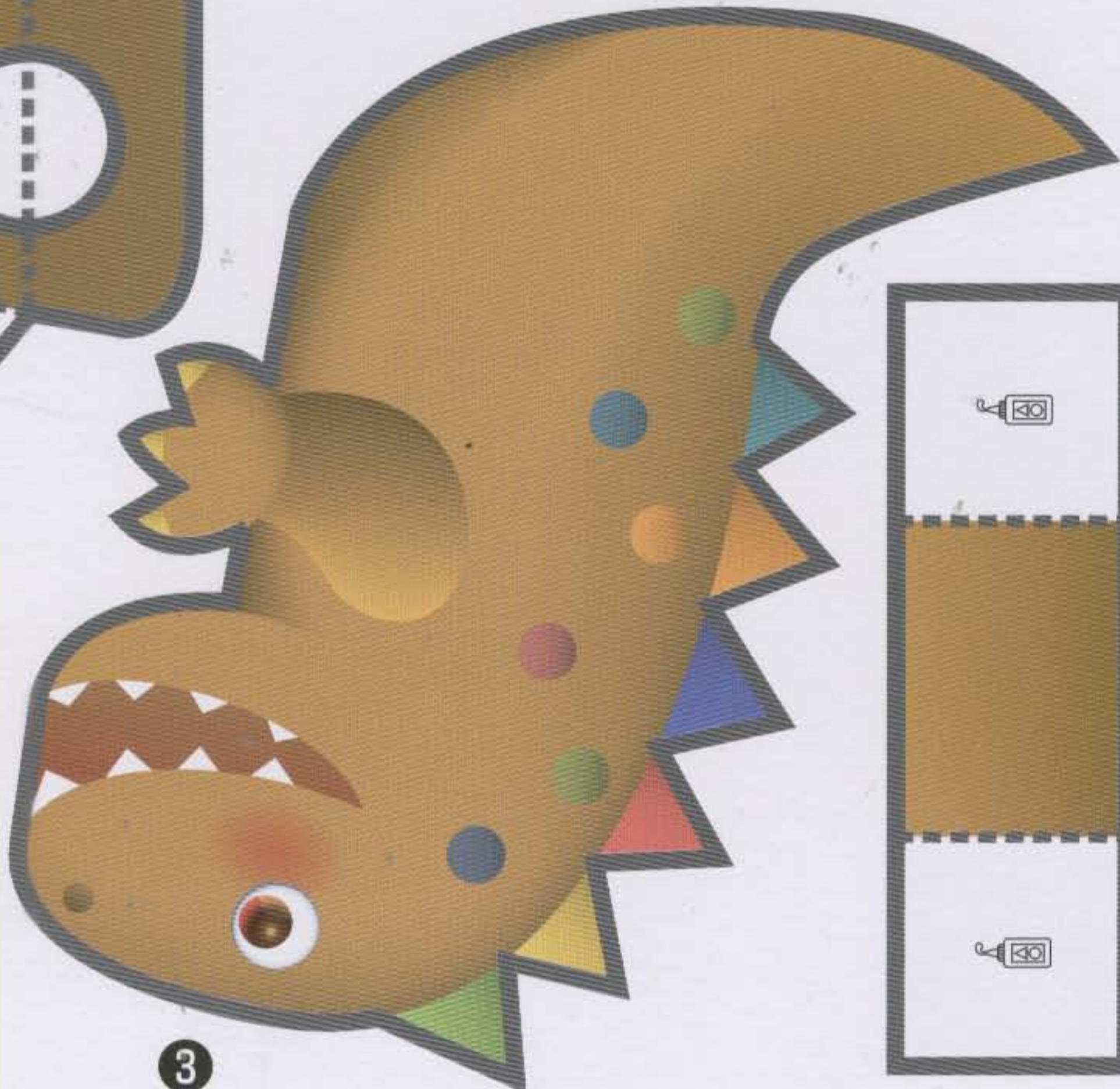
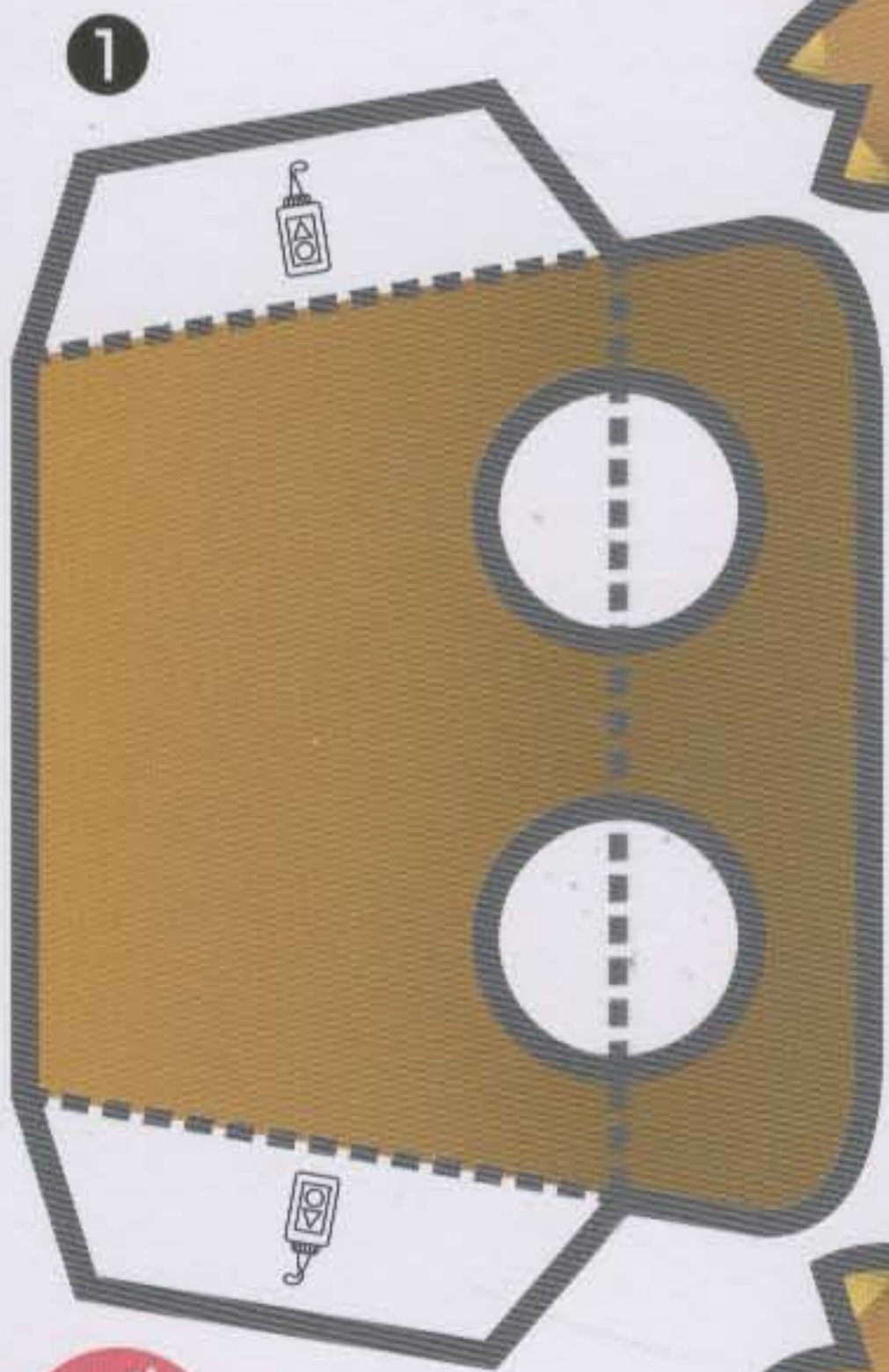
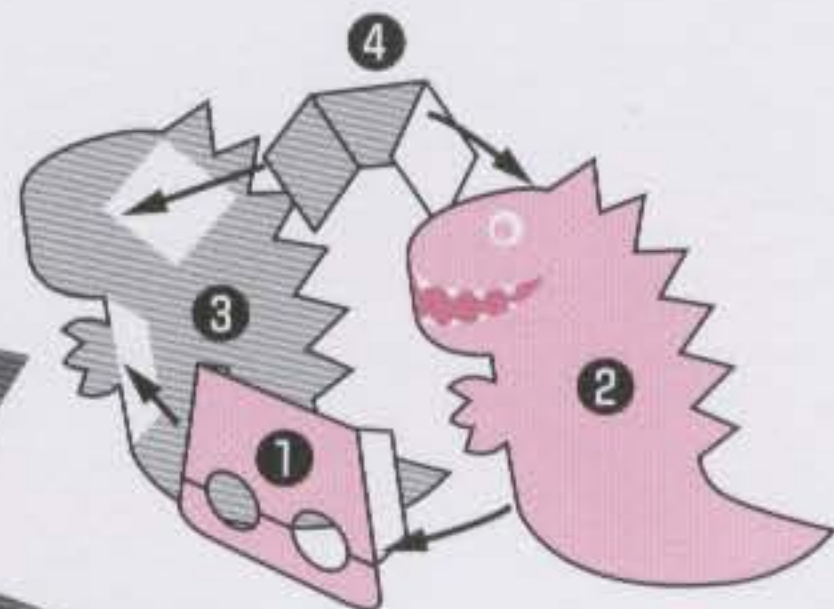
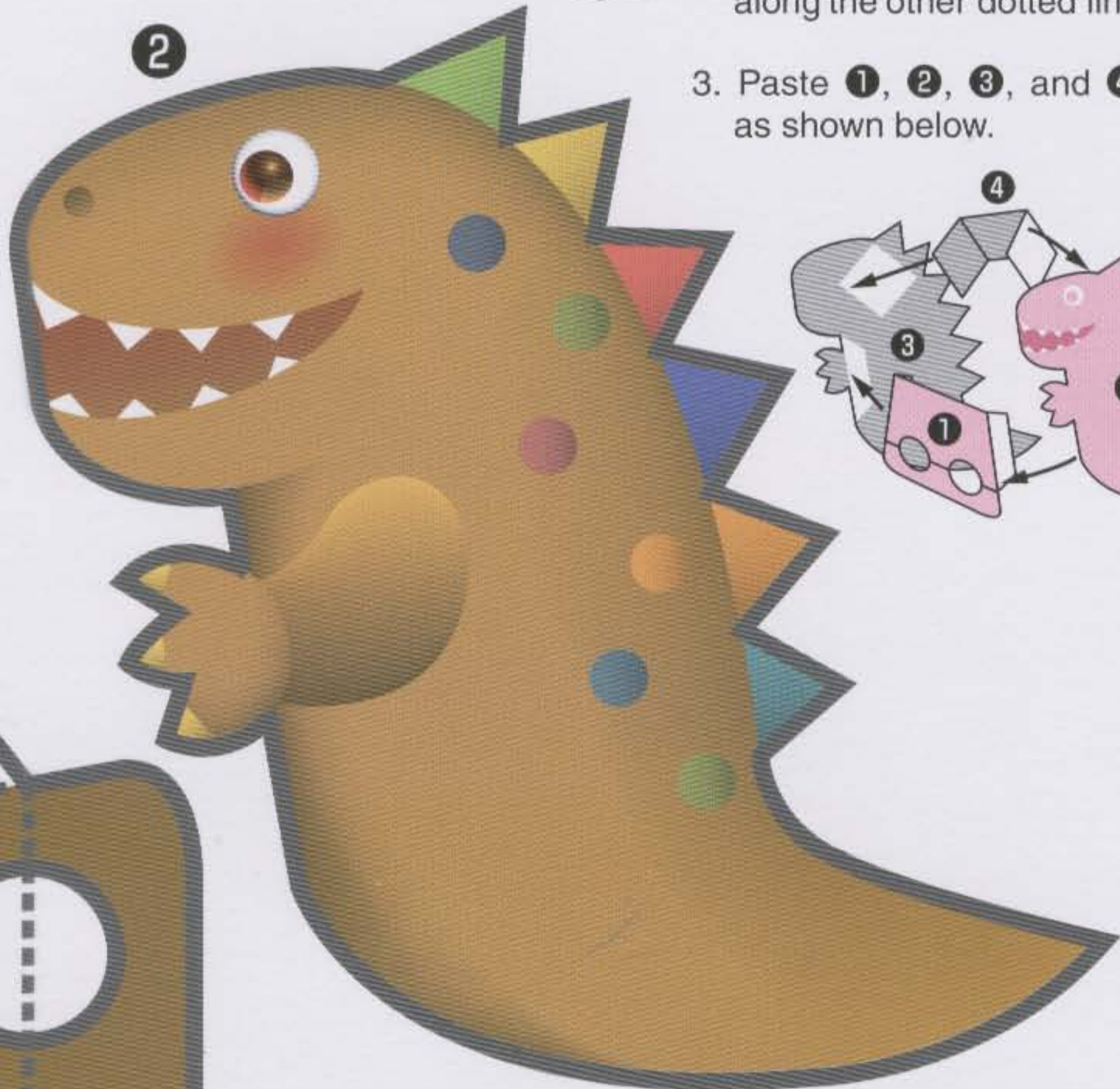
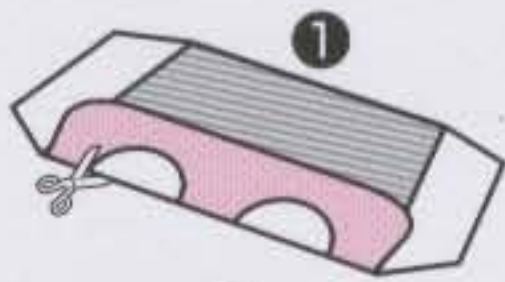

### HOW TO PLAY



Put your first and middle fingers into the holes to make the dinosaur walk.

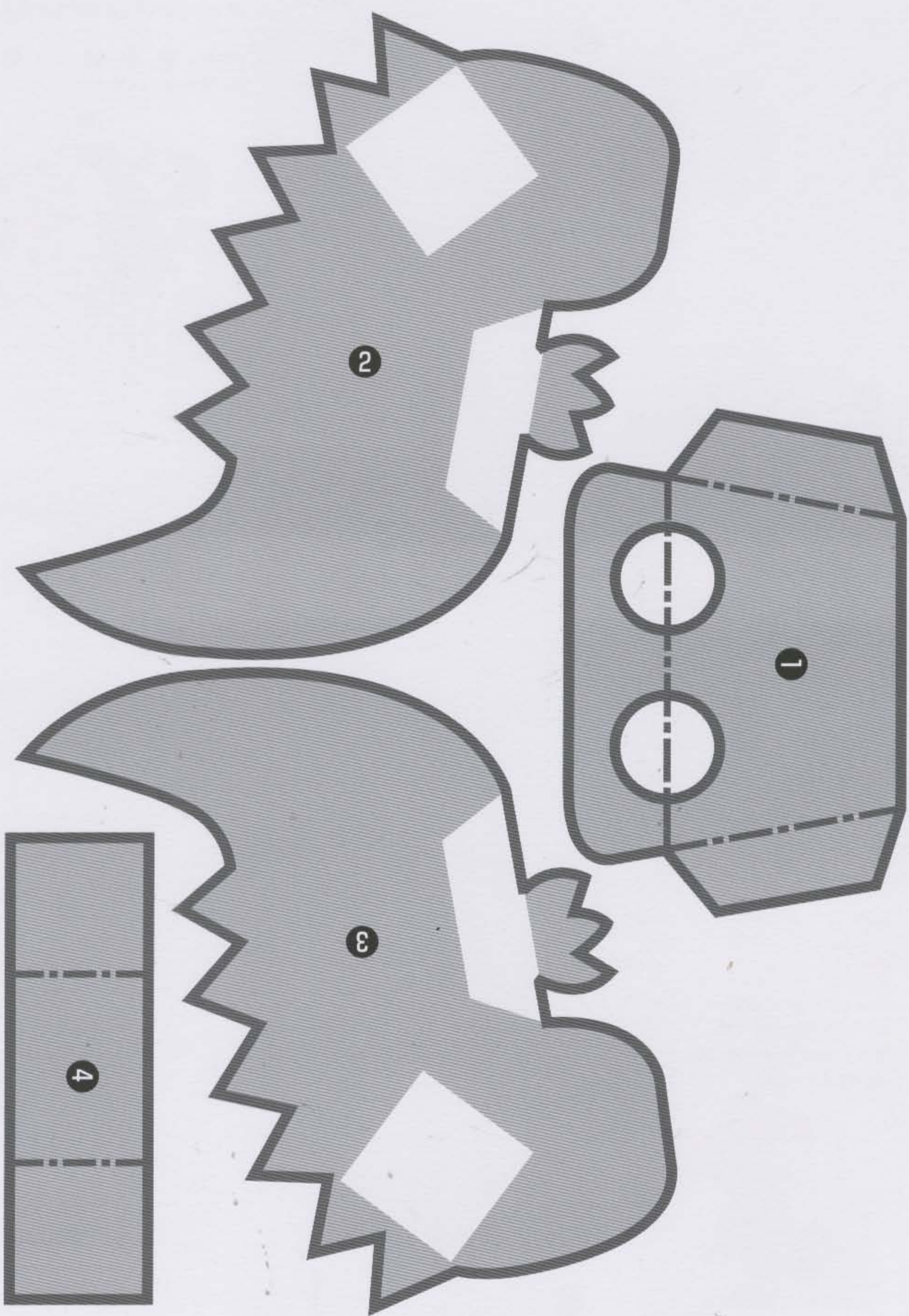

\*Parents, please cut along this line for your child.



## Walking Robot

1. Cut along the thick lines .
2. Fold downwards along the horizontal dotted line  at the bottom. Cut out the two holes and unfold.
3. Paste the tabs of ① onto the adjacent sides after folding.
4. Fold each piece of ② upwards along the dashed line  and then attach onto ①.

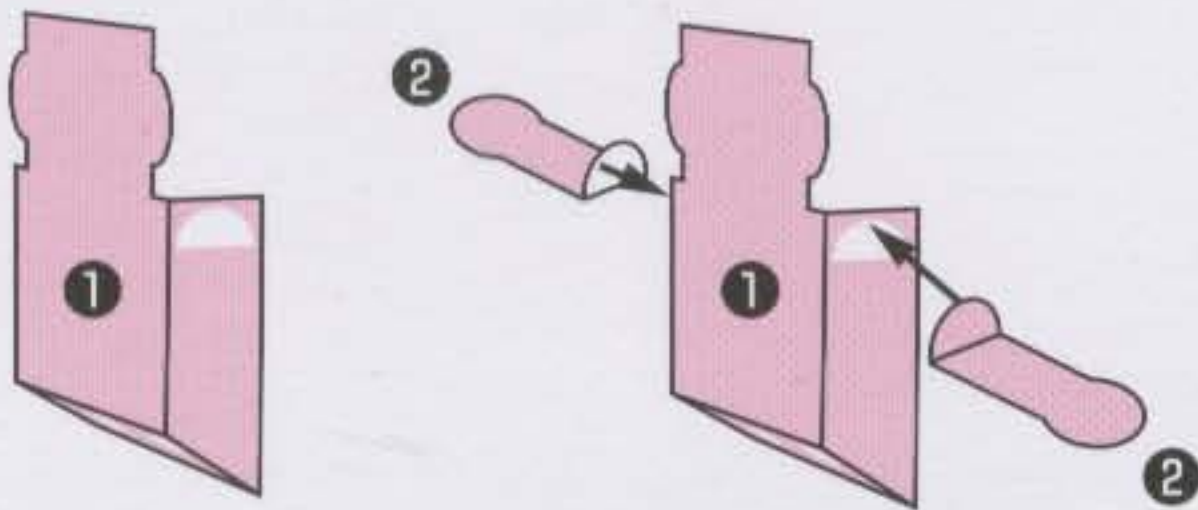
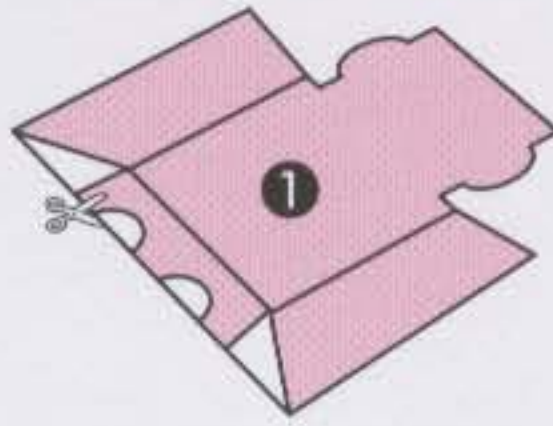

**HOW TO PLAY**

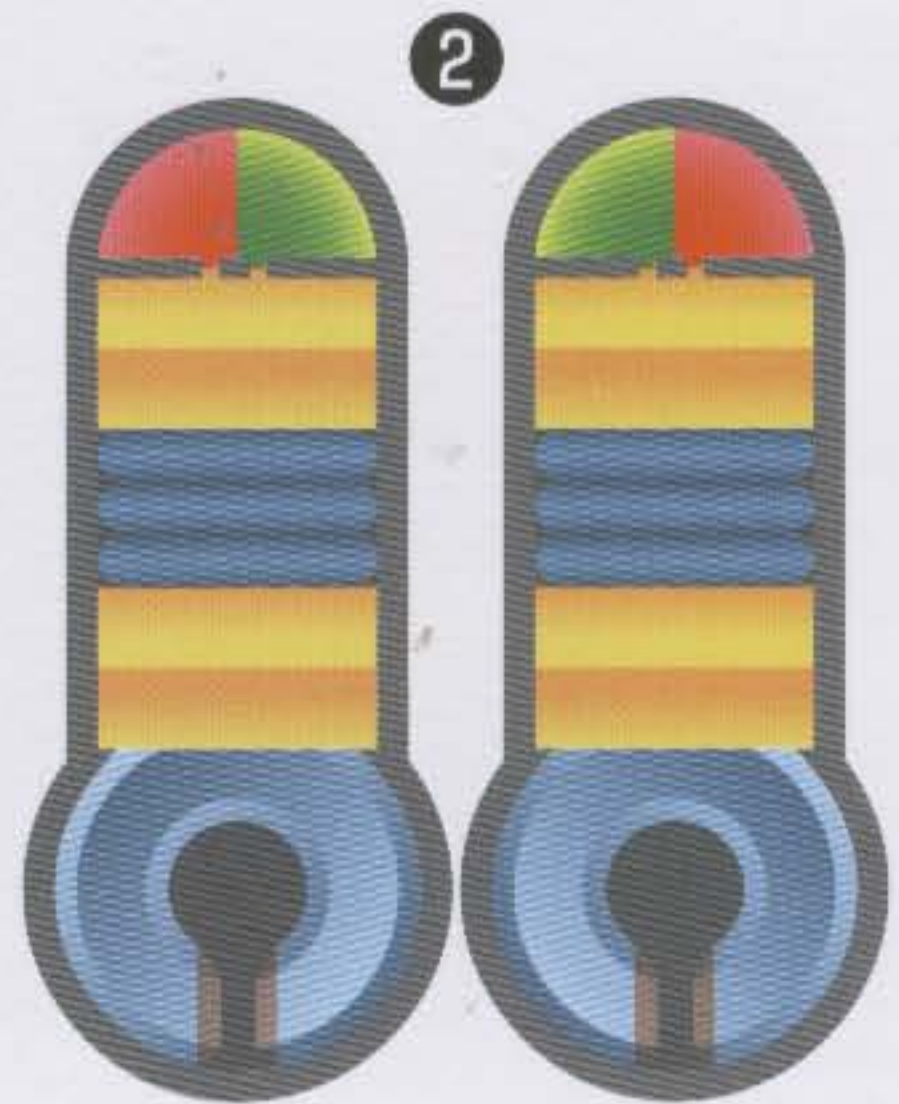
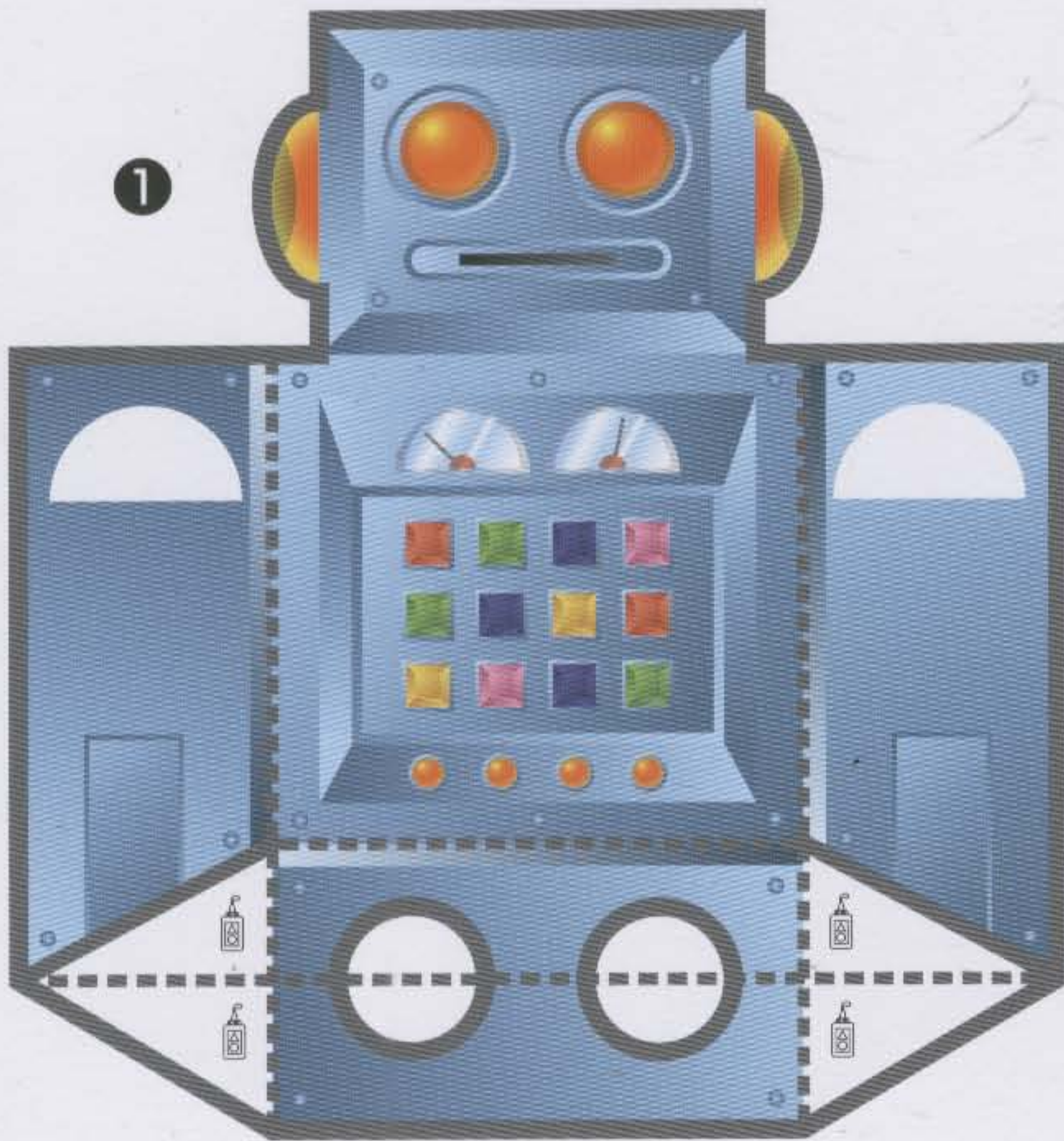

Put your first and middle fingers into the holes to make the robot walk.

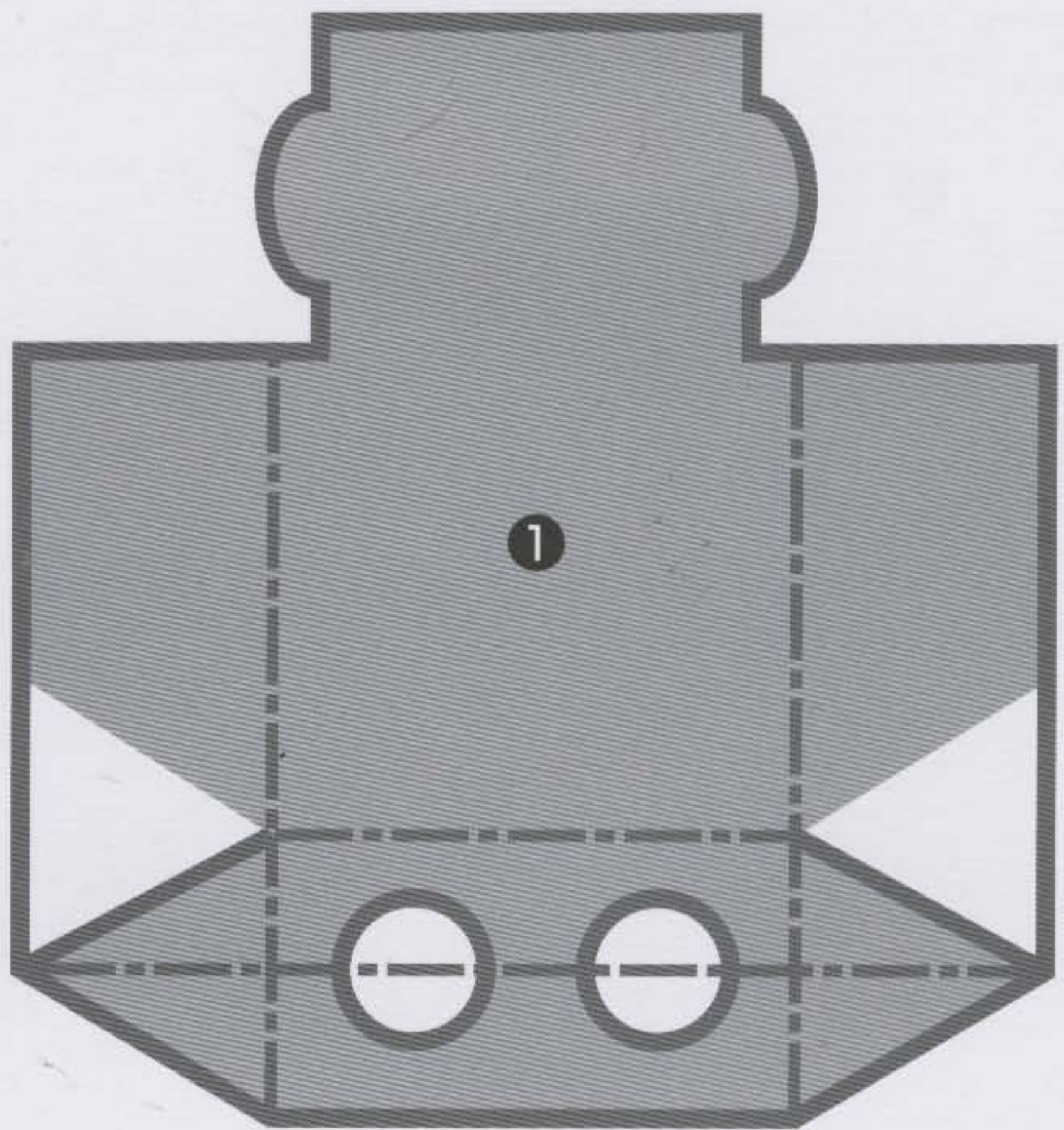
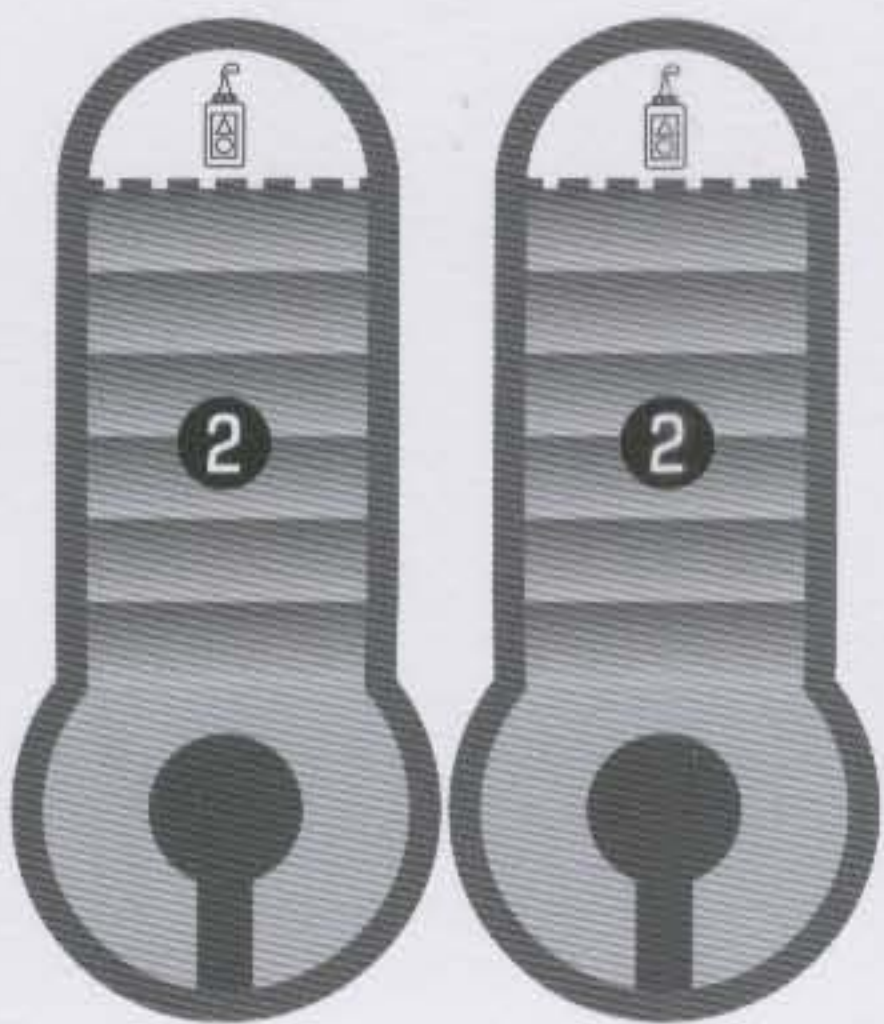





## Clapping Cat

1. Cut along the thick lines .
2. Fold downwards along the dotted lines  and upwards along the dashed lines .

**HOW TO PLAY**



Hold the top of the cat's head and the bottom of the cat's feet. Pull the head up repeatedly.

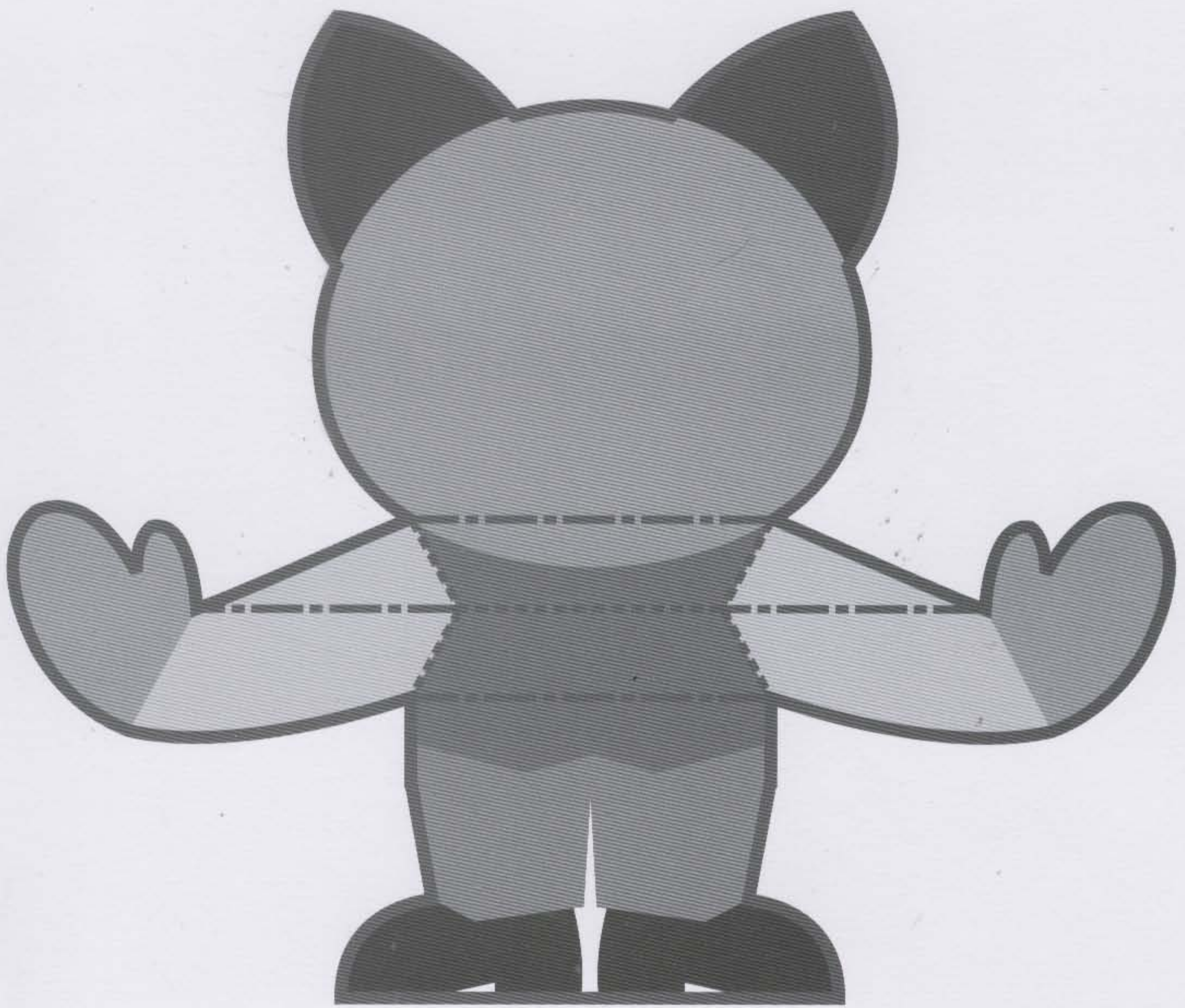

\*Parents, please cut along this line for your child.

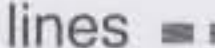

## Boxers

1. Cut along the thick lines .
2. Fold downwards along the dotted lines  and upwards along the dashed lines .

HOW TO PLAY

Push and pull the side flaps. The boxers will fight.

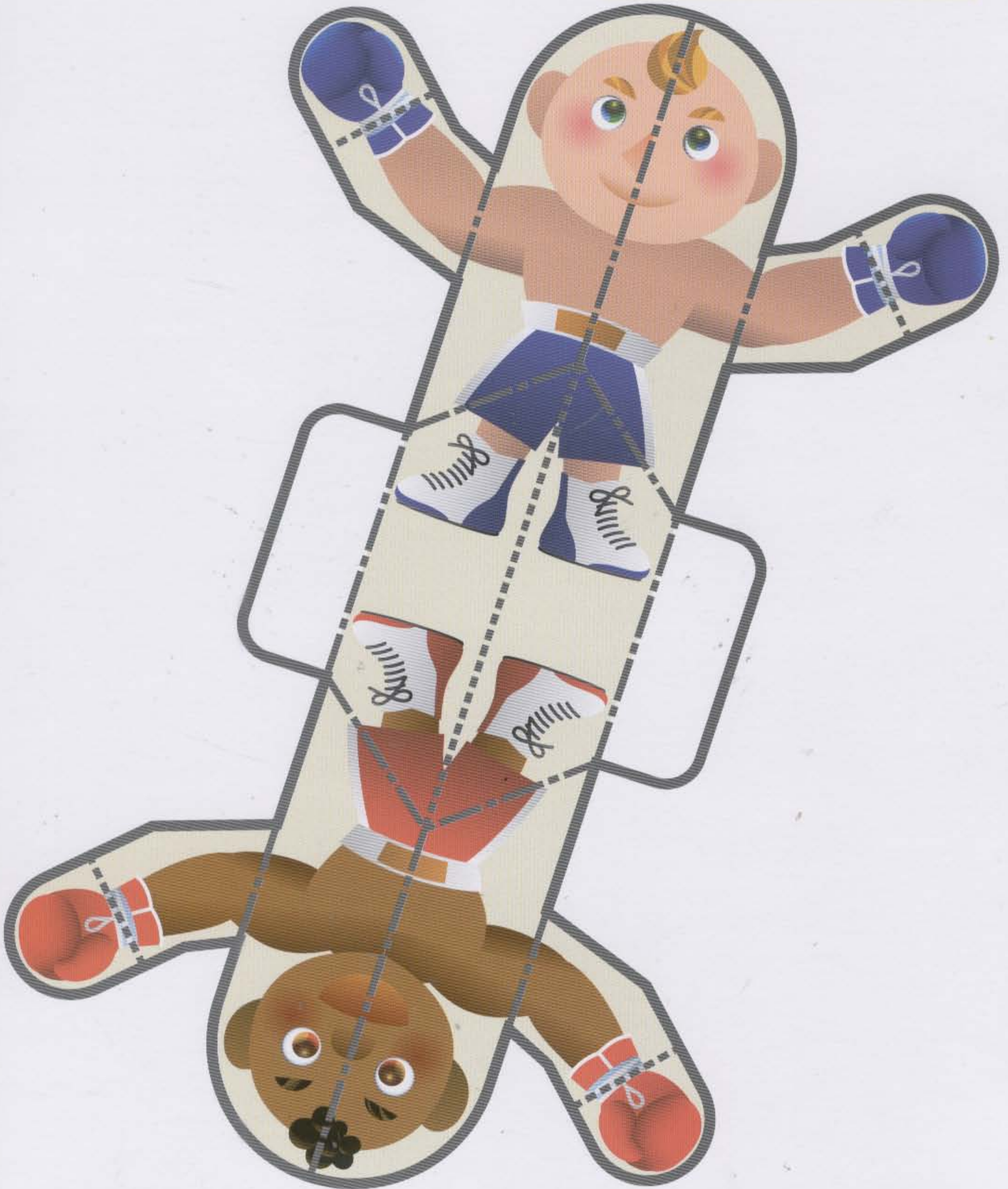
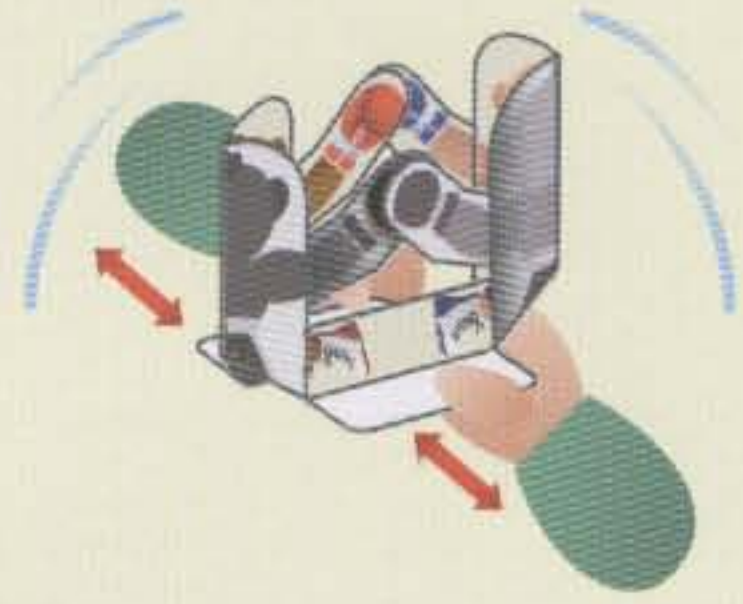

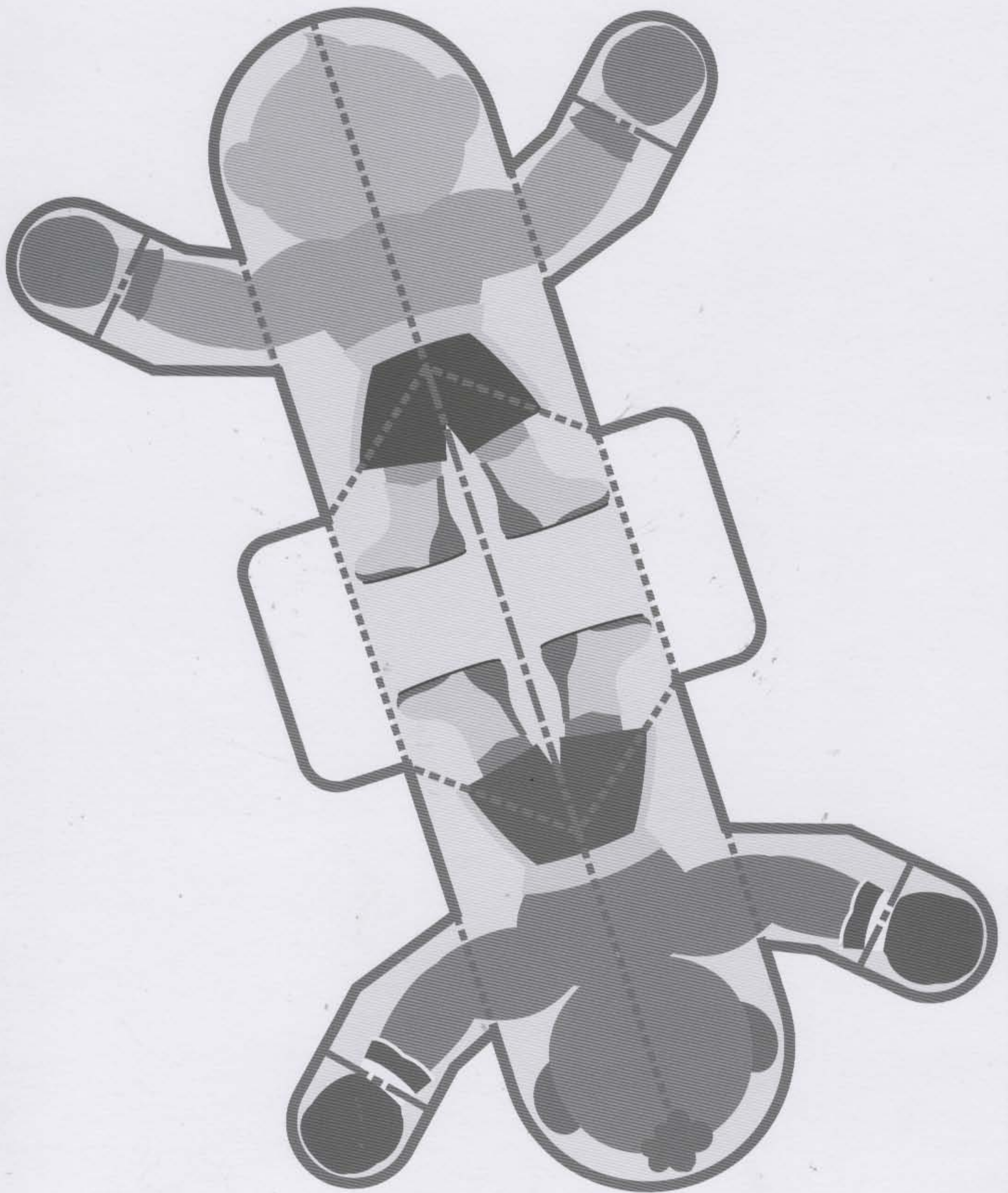

## Crawling Lizard

1. Cut along the thick lines .

2. Curl **1** into a ring and paste the edges together.

3. Attach **2** and **3** onto **1**.

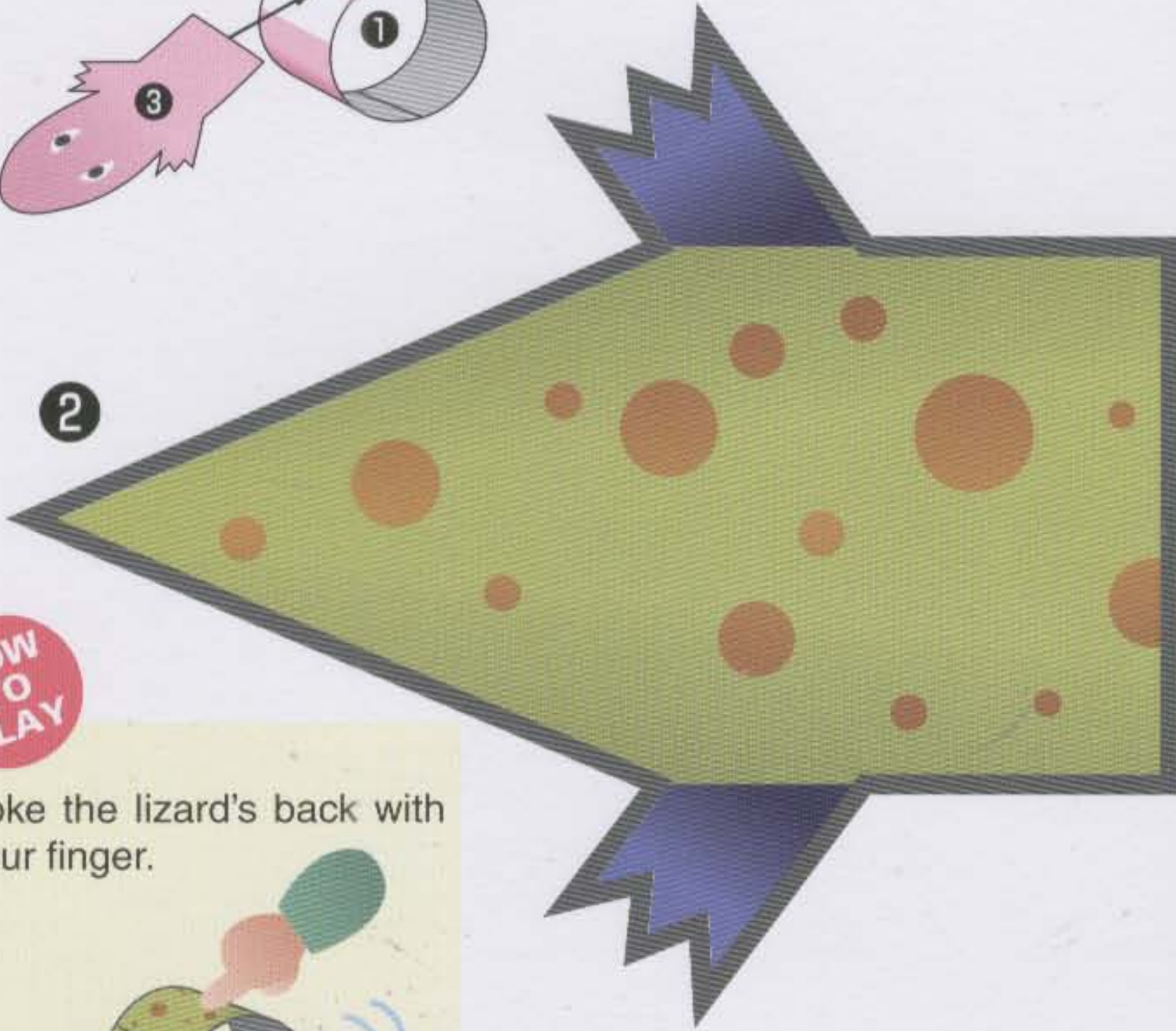
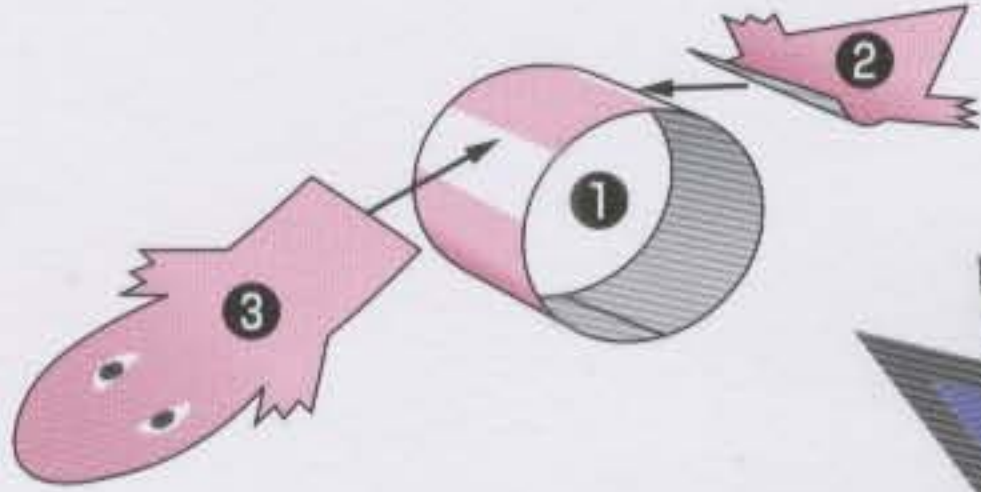
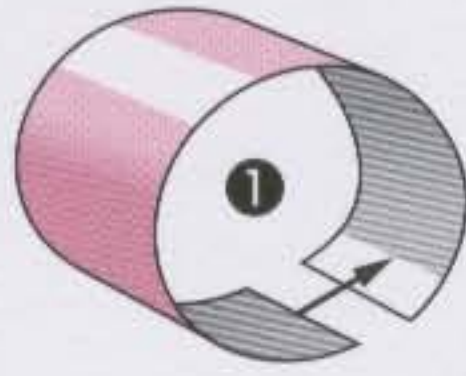

**HOW TO PLAY**

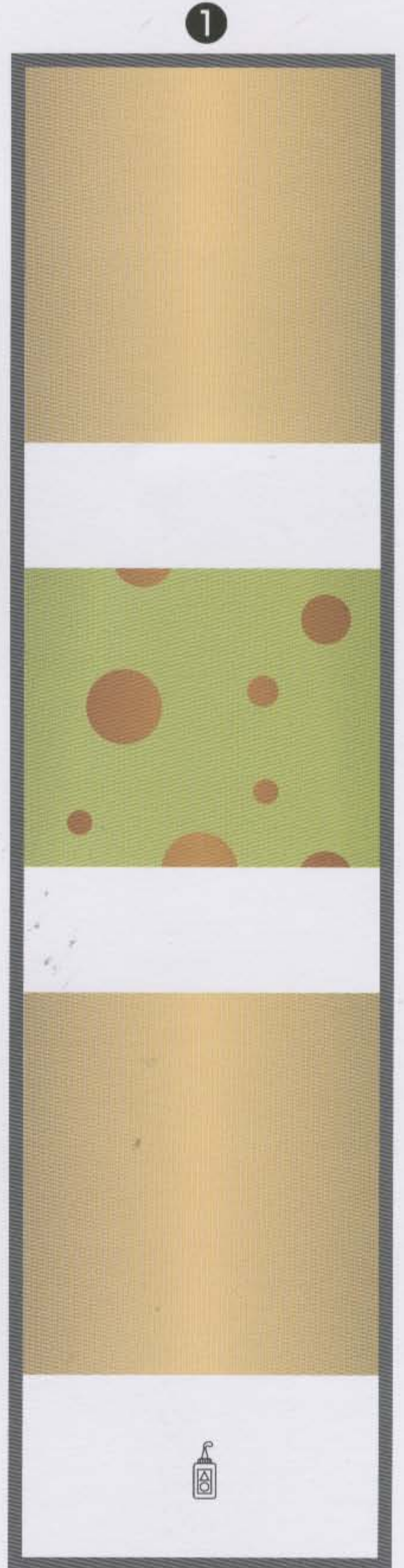
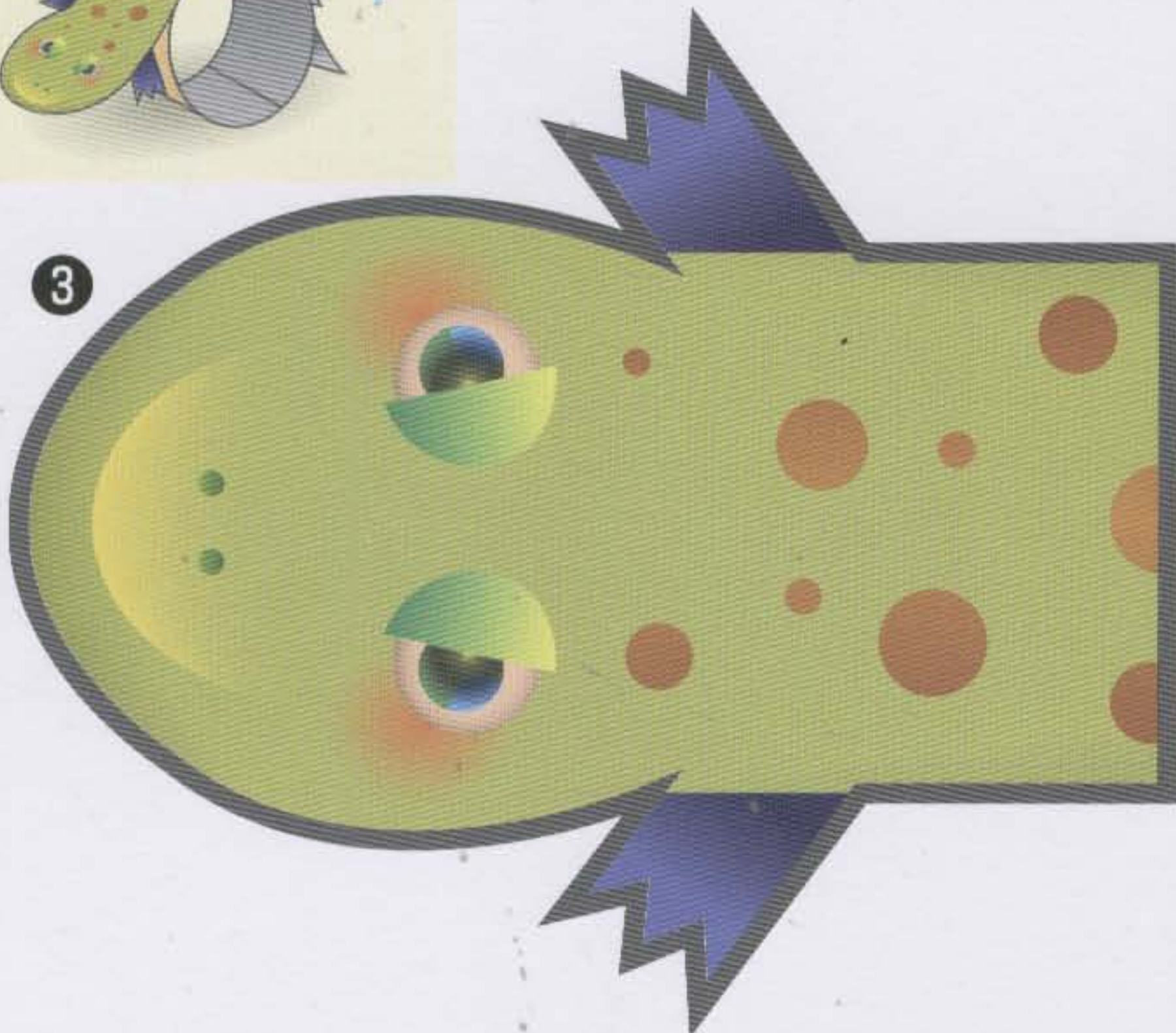

Poke the lizard's back with your finger.

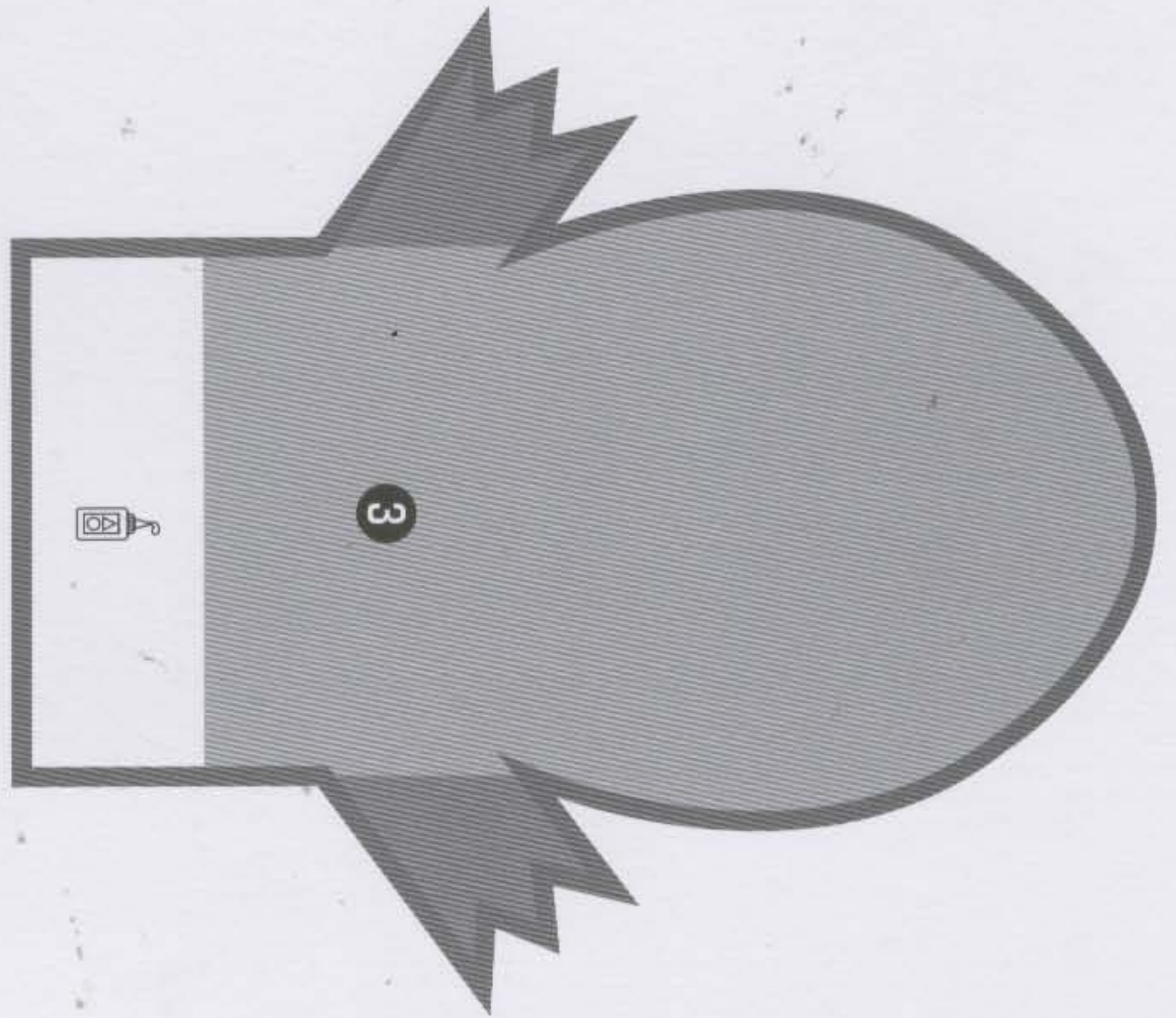
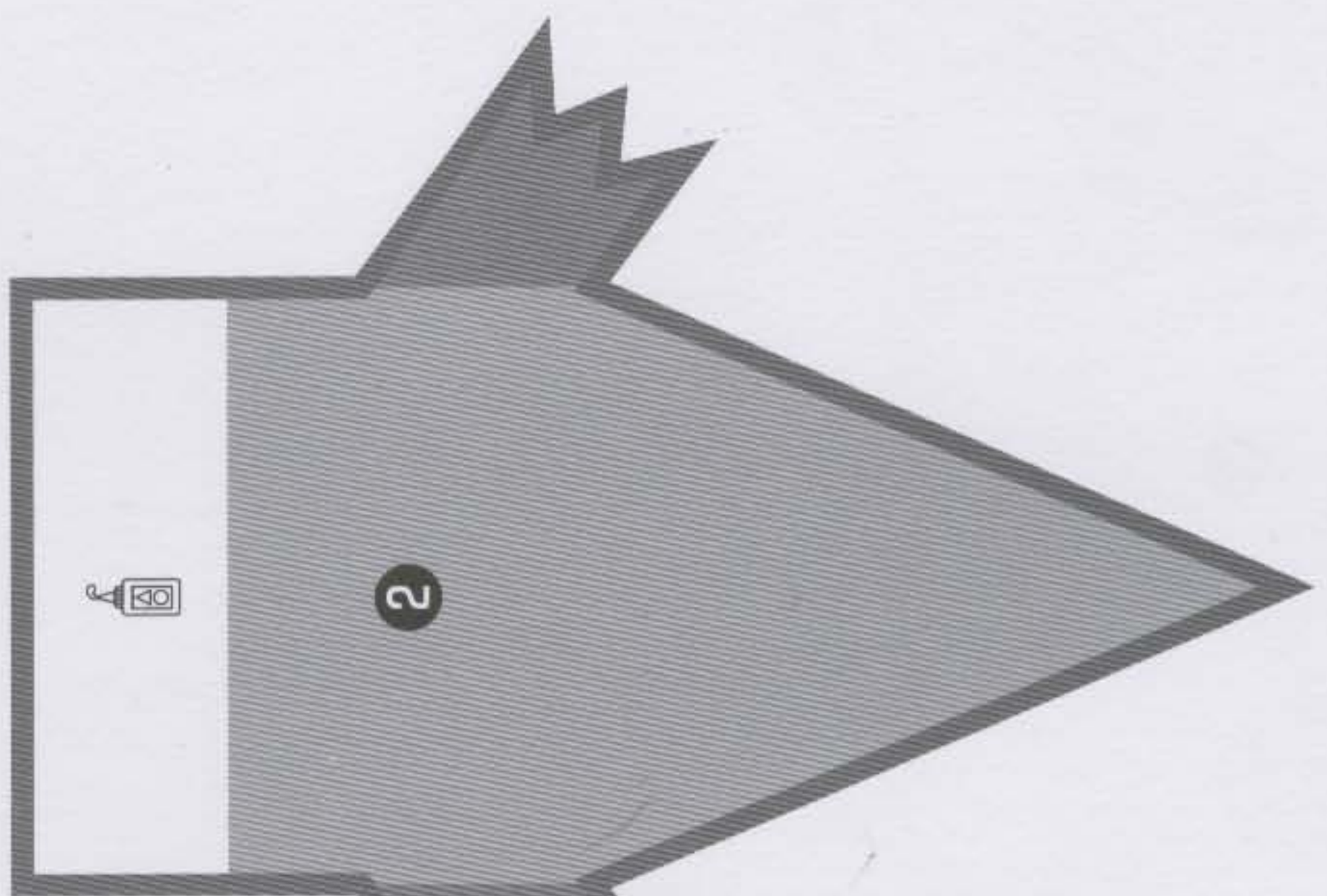



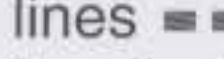

## Flapping Rooster

1. Cut along the thick lines .

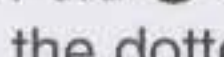
2. Fold **1** downwards along the dotted lines  and upwards along the dashed lines . Paste the edges together.

3. Fold **2** and **3** downwards along the dotted lines  and paste the half-circle tabs onto **1**.

4. Fold **4** downwards along the dotted line . Paste the insides and attach to **2** and **3**.

**HOW TO PLAY**

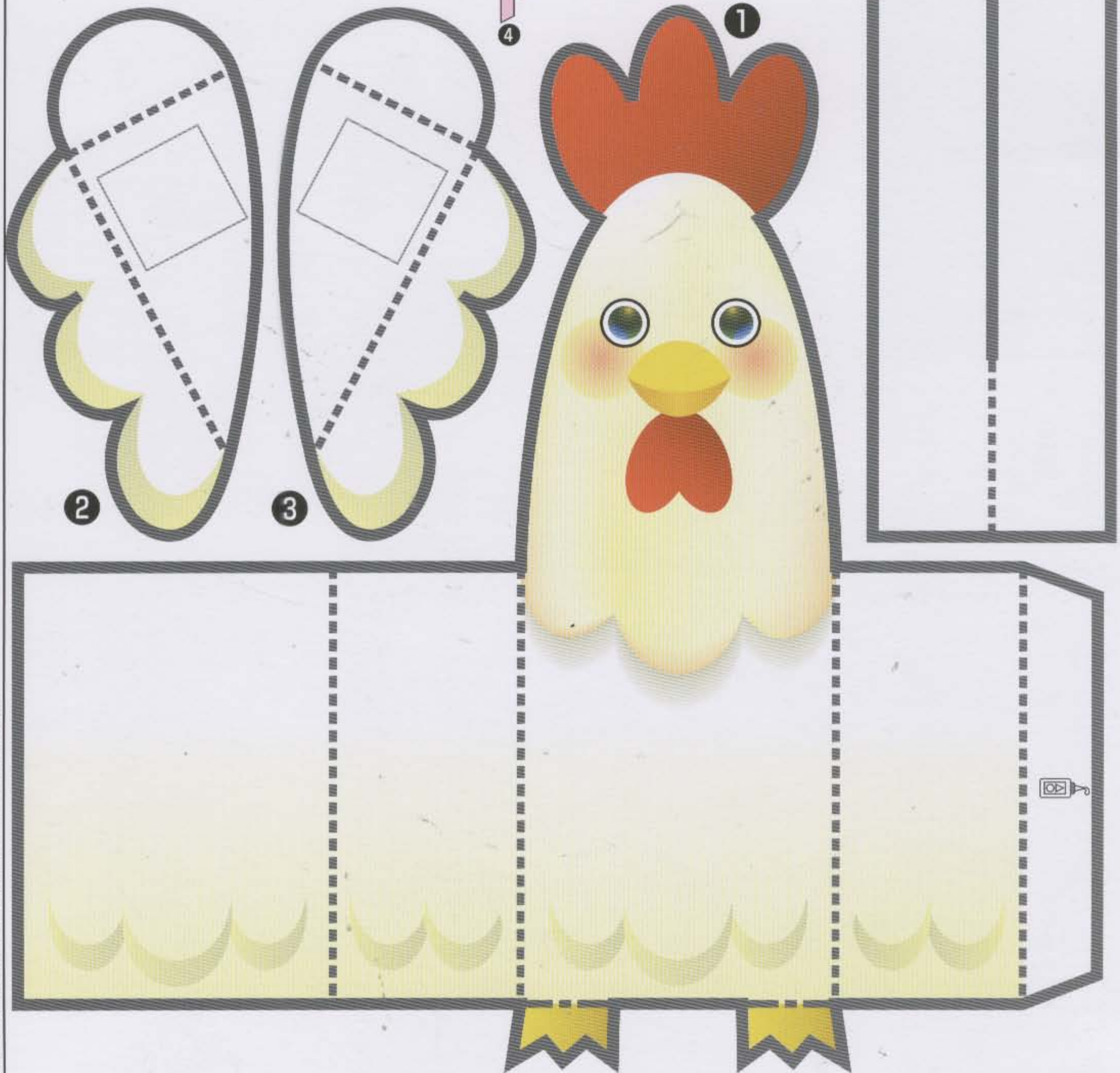
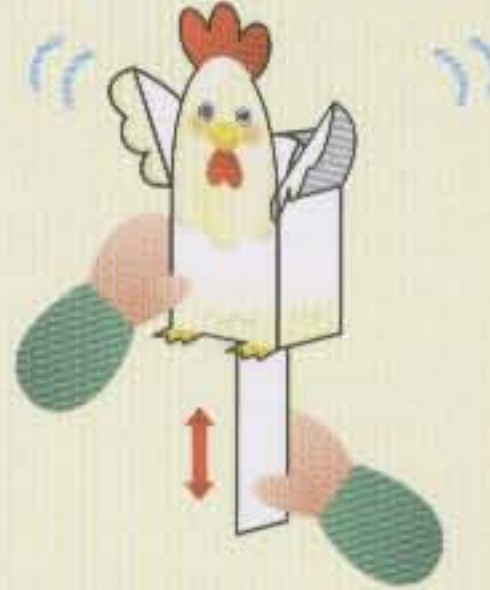

Move **4** up and down. The rooster will flap its wings.

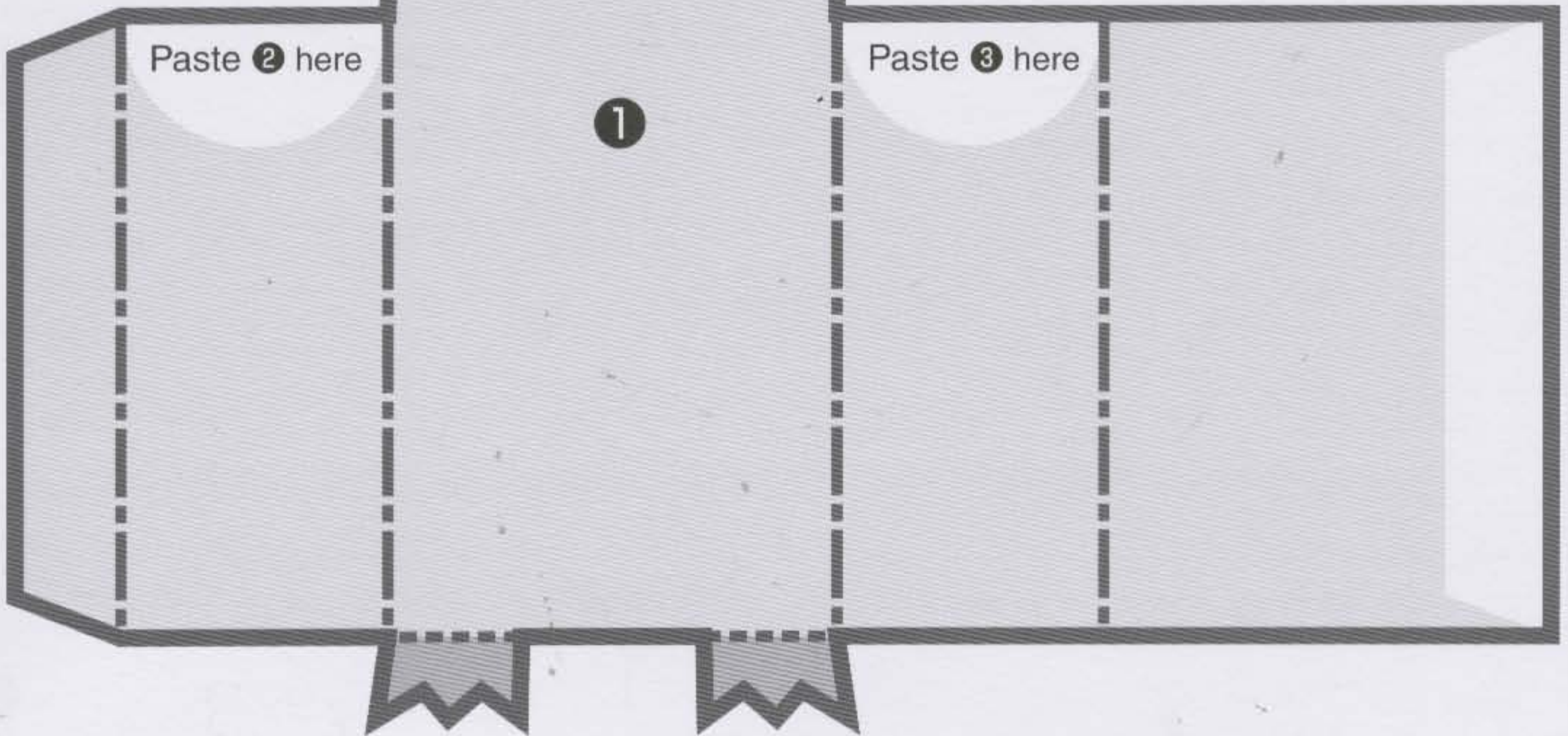
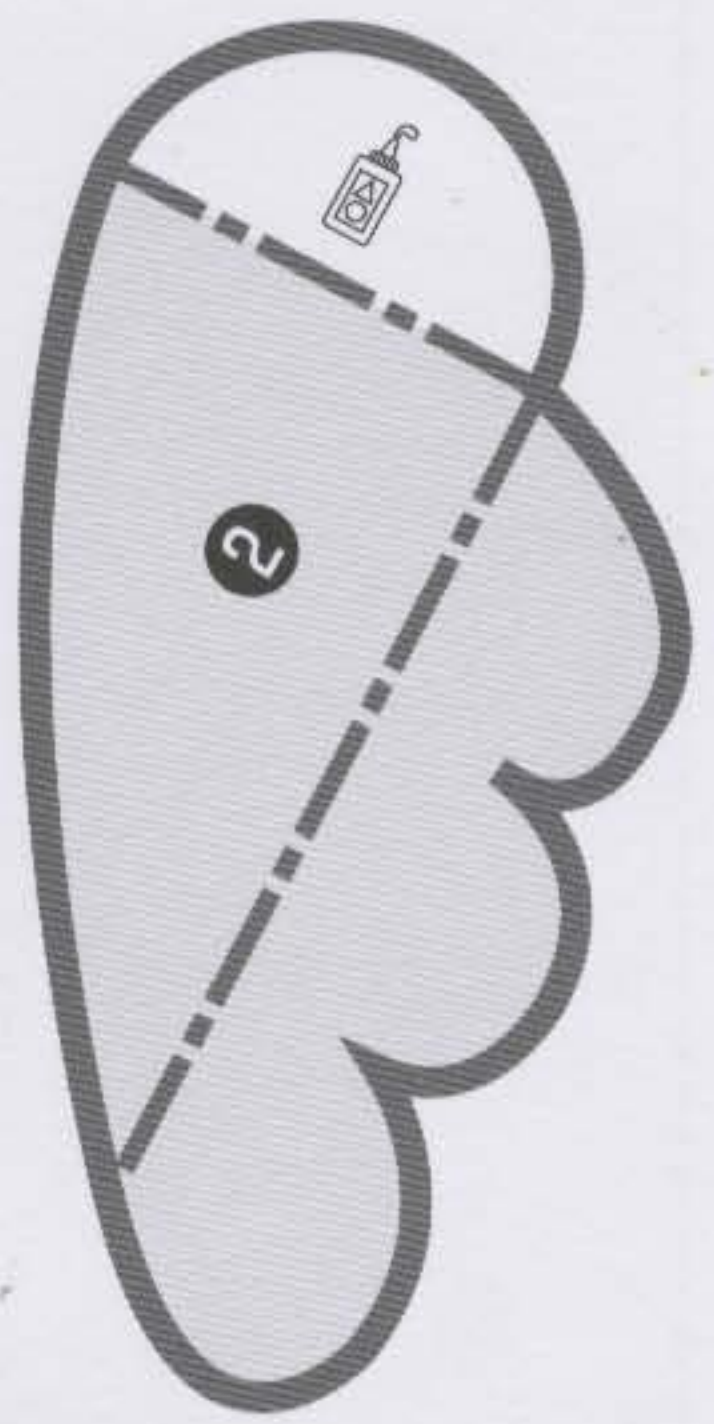
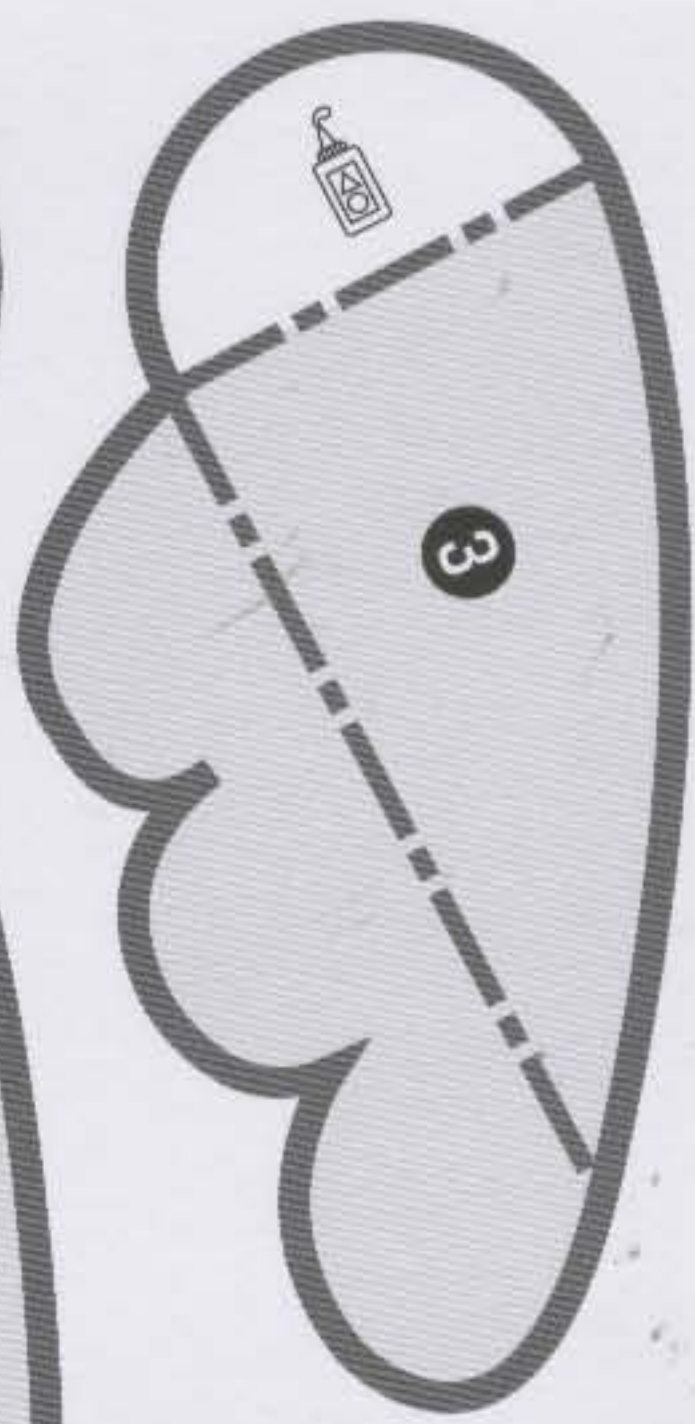
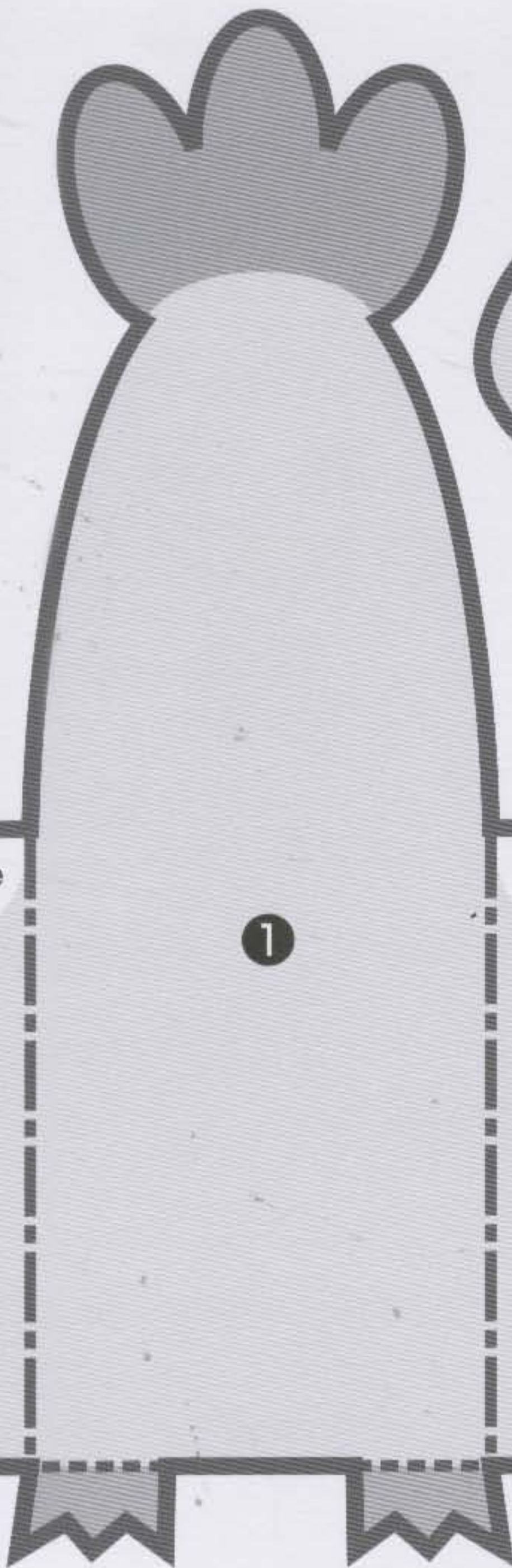
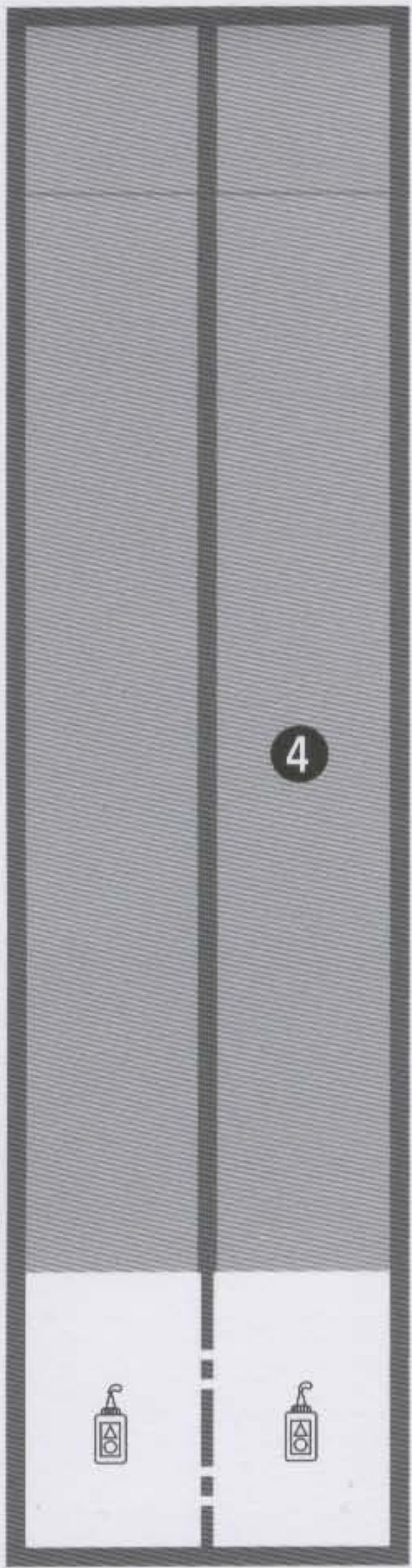



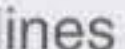

## Dancing Dog

1. Cut along the thick lines .
2. Fold **1** downwards along the dotted lines  and upwards along the dashed lines . Paste the overlapping tabs to complete **1**.
3. Paste **2** and **3** onto **1**.

**HOW TO PLAY**

Hold and shift either pair of facing edges. The dog will dance.

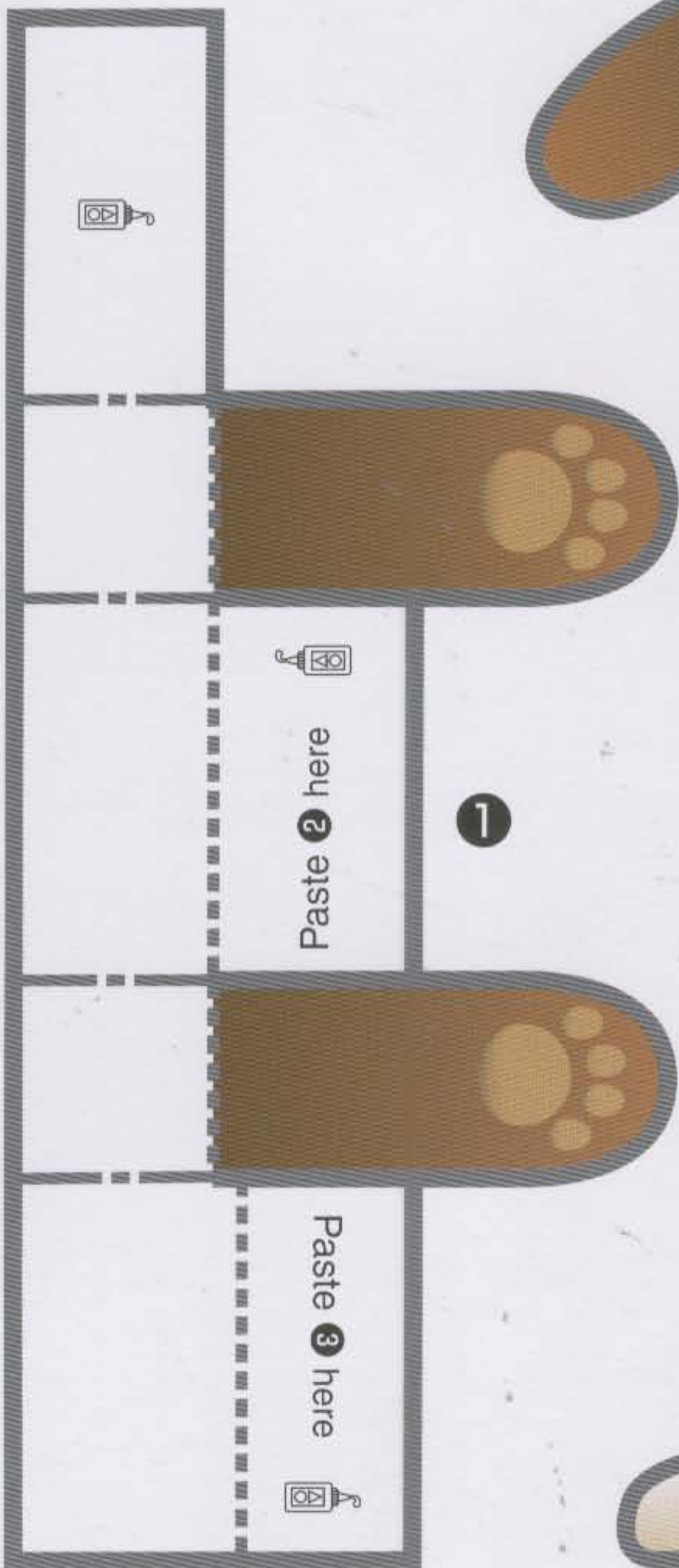
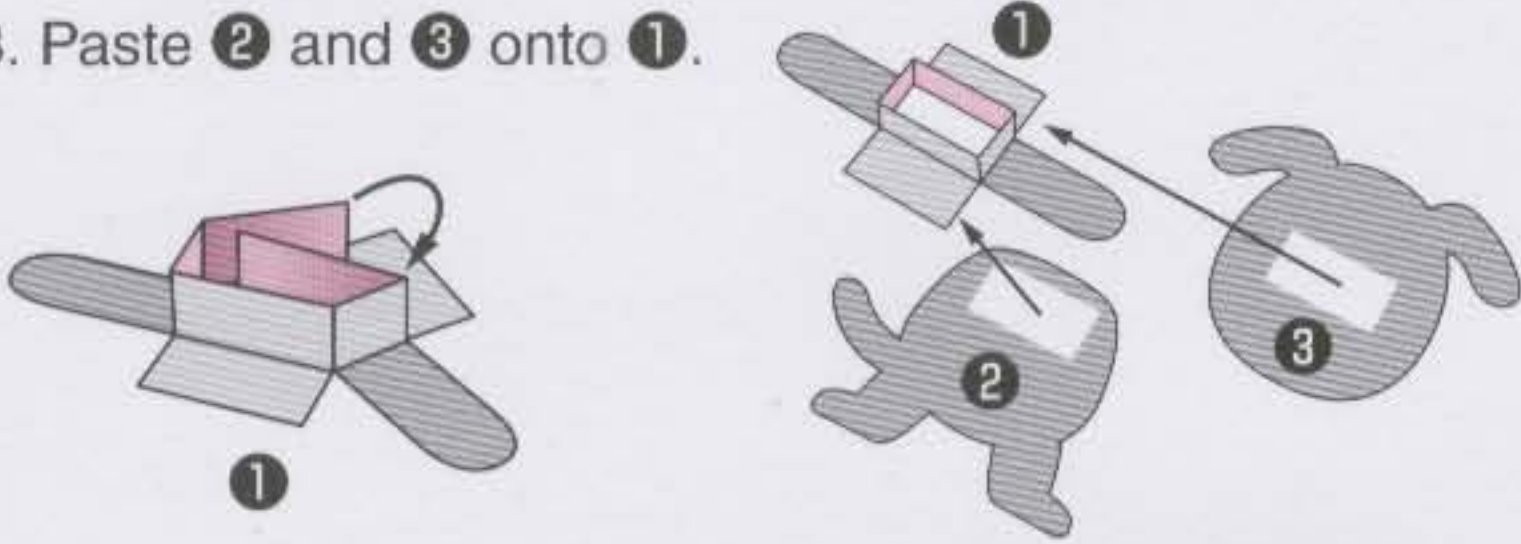

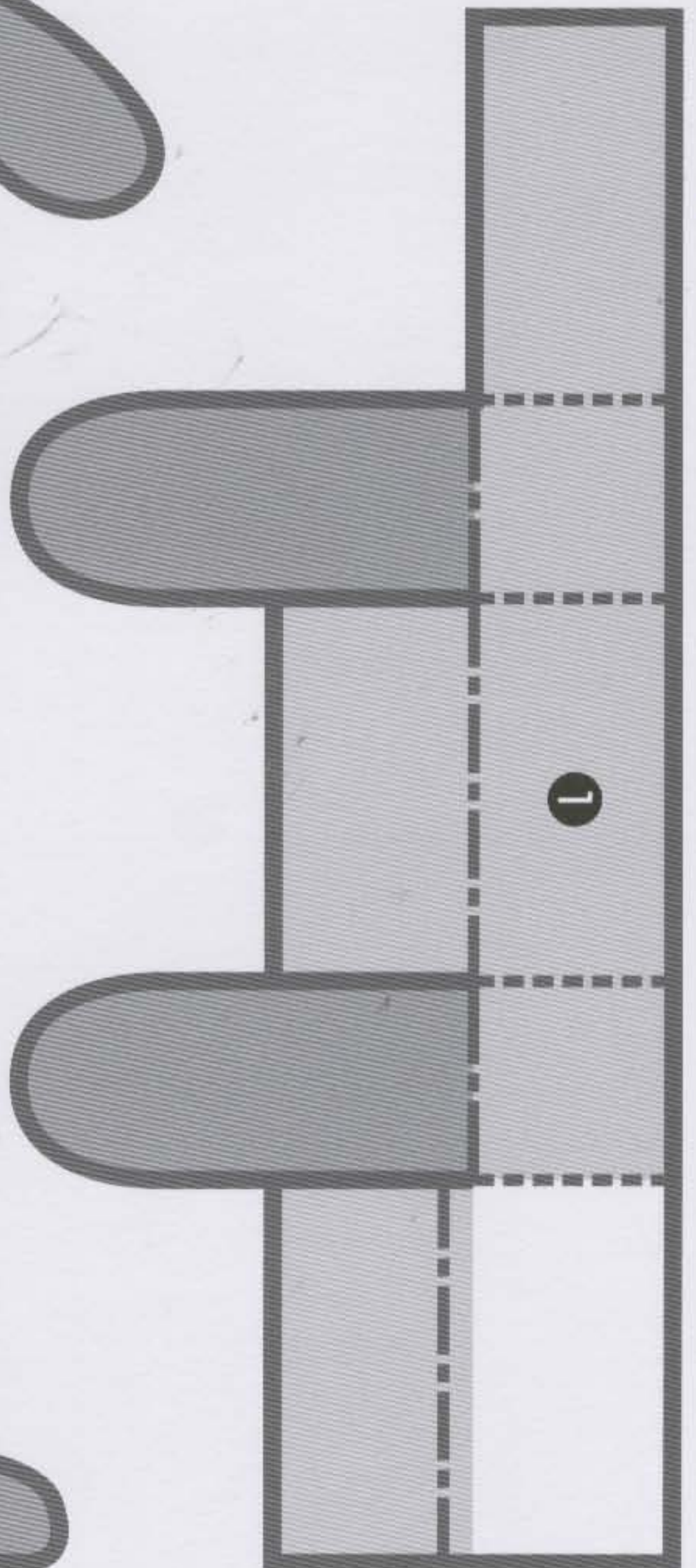
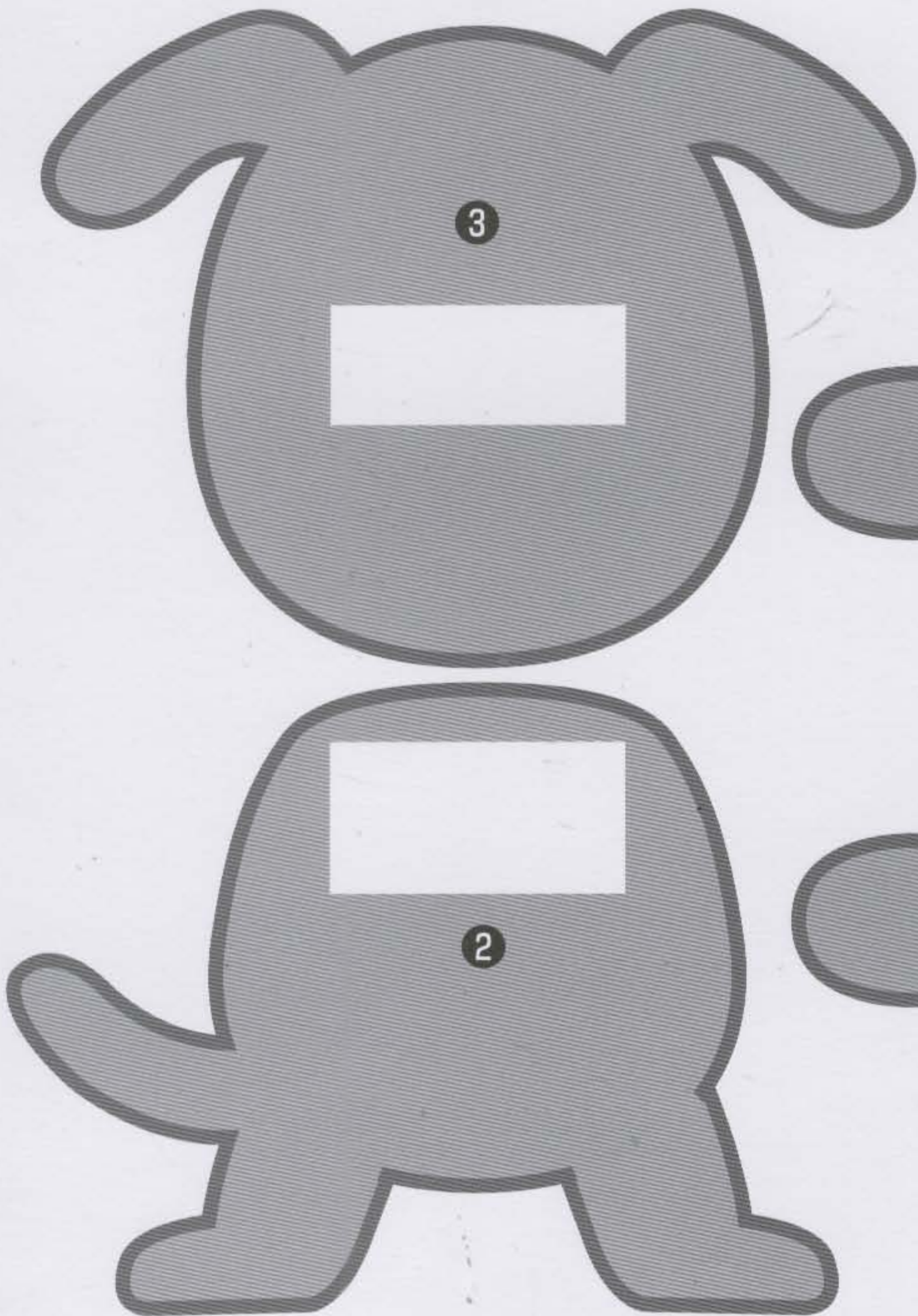

## Barking Dog

**HOW TO PLAY**

Put your fingers into the rings on the back and open and shut the dog's mouth.

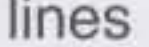
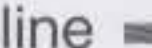

1. Cut along the thick lines .
2. Fold **1** downwards along the dotted lines  and upwards along the dashed line . Paste each tab onto the back of the adjacent edge.

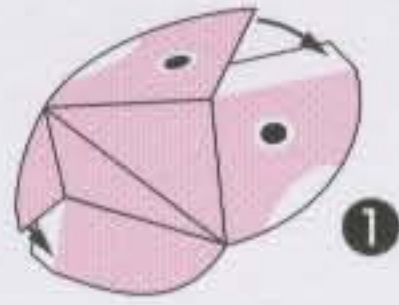

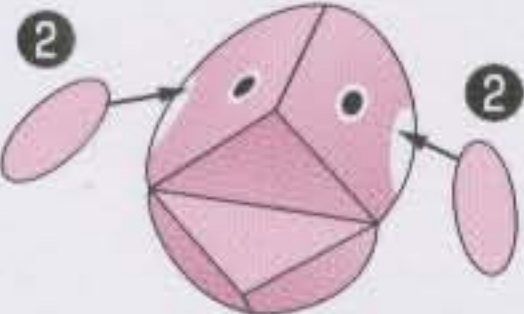
3. Paste **2** onto **1**. 

4. Fold **3** downwards along the dotted lines . Paste the overlapping tabs of both pieces of **3**. Paste the completed rings of **3** onto the back of **1**.

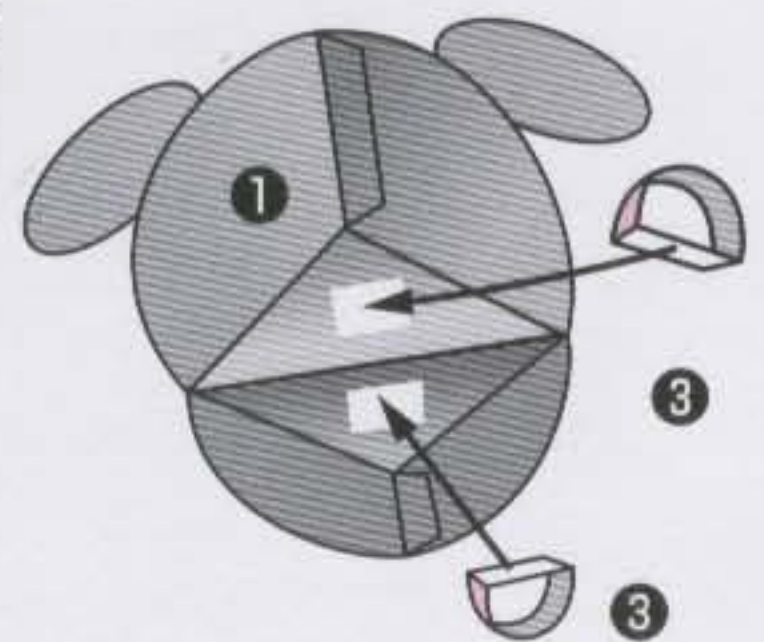
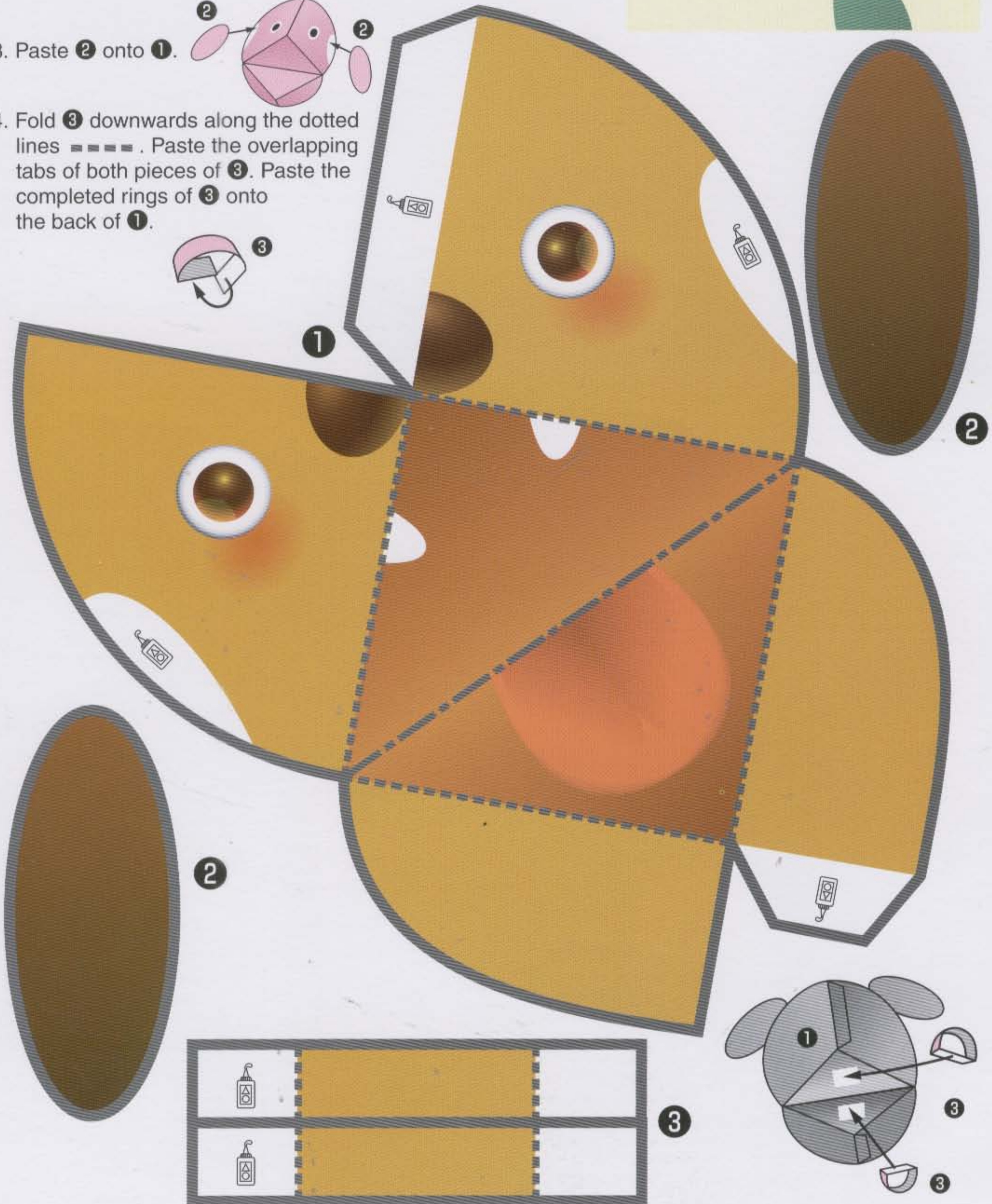

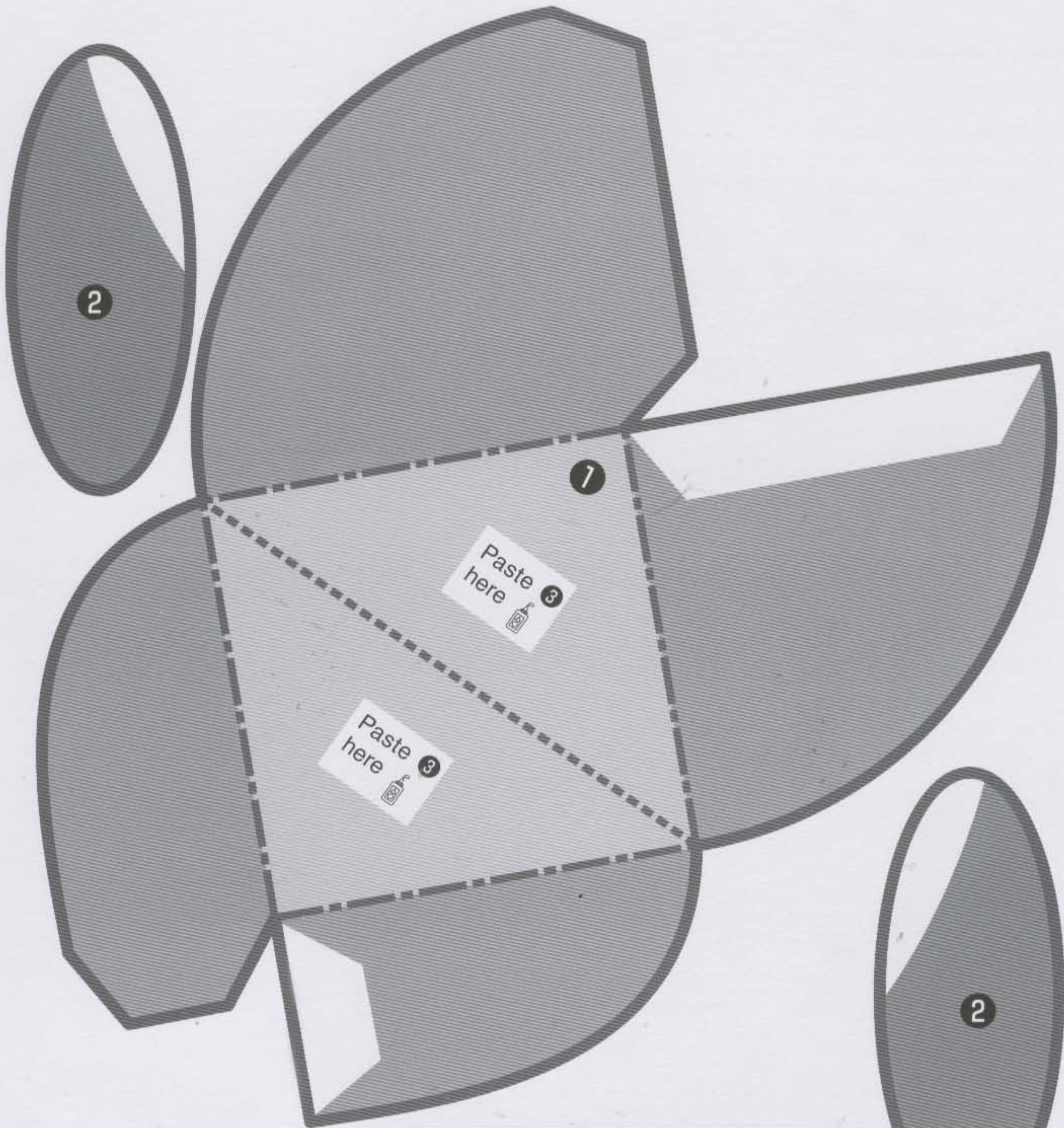

## Biting Alligator

1. Cut along the thick lines .

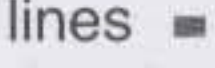
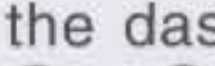
2. Fold downwards along the dotted lines  and upwards along the dashed line . Attach **2** to **1**.

3. Sandwich **2** between the top and bottom of **1** and paste the tab onto the front part of **1** as shown on the right.

4. Attach **3**, **4**, **5**, and **6** to **1**.

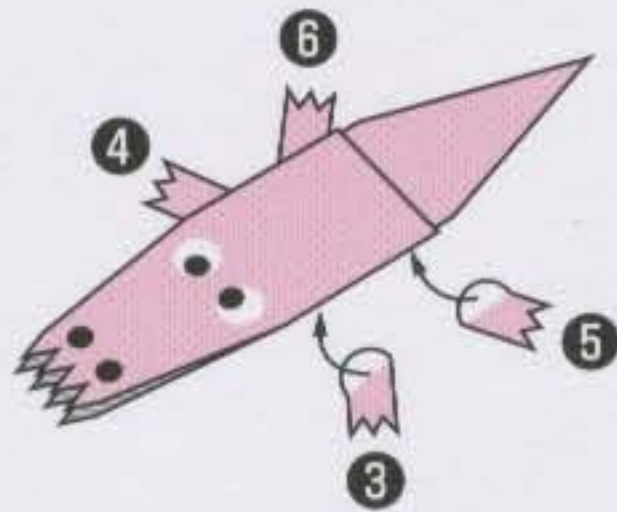
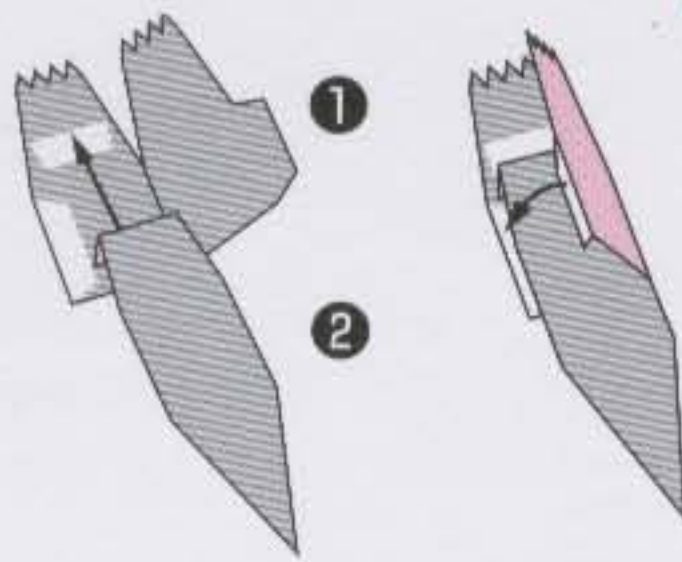

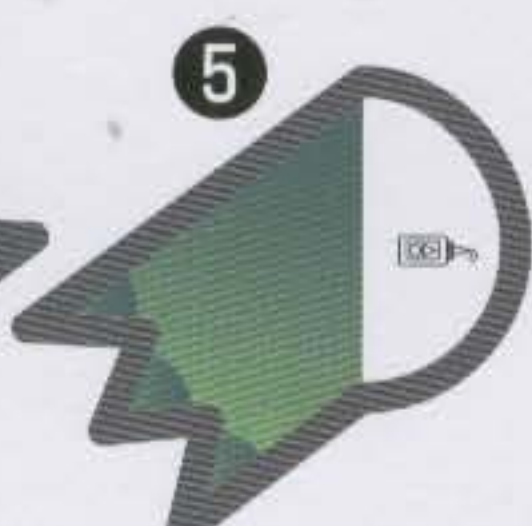
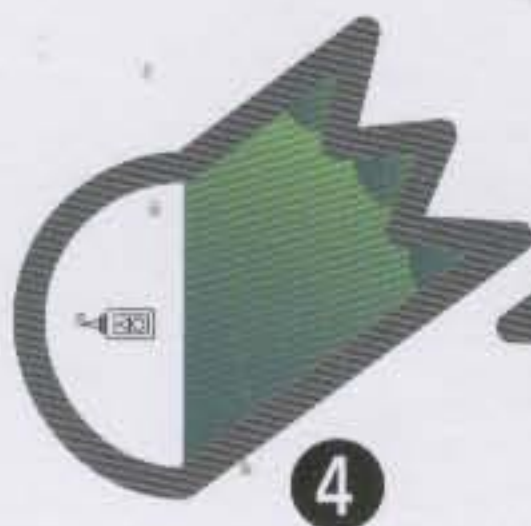
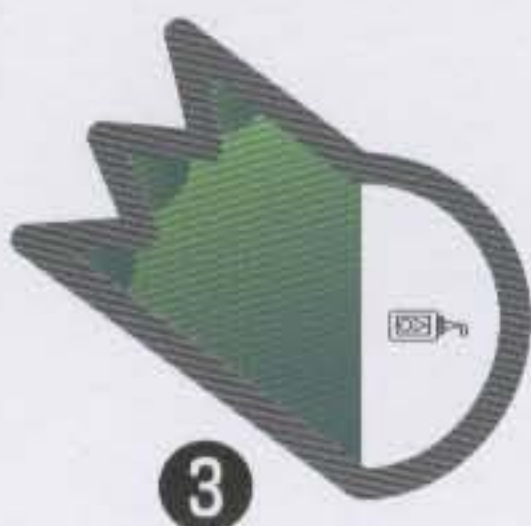
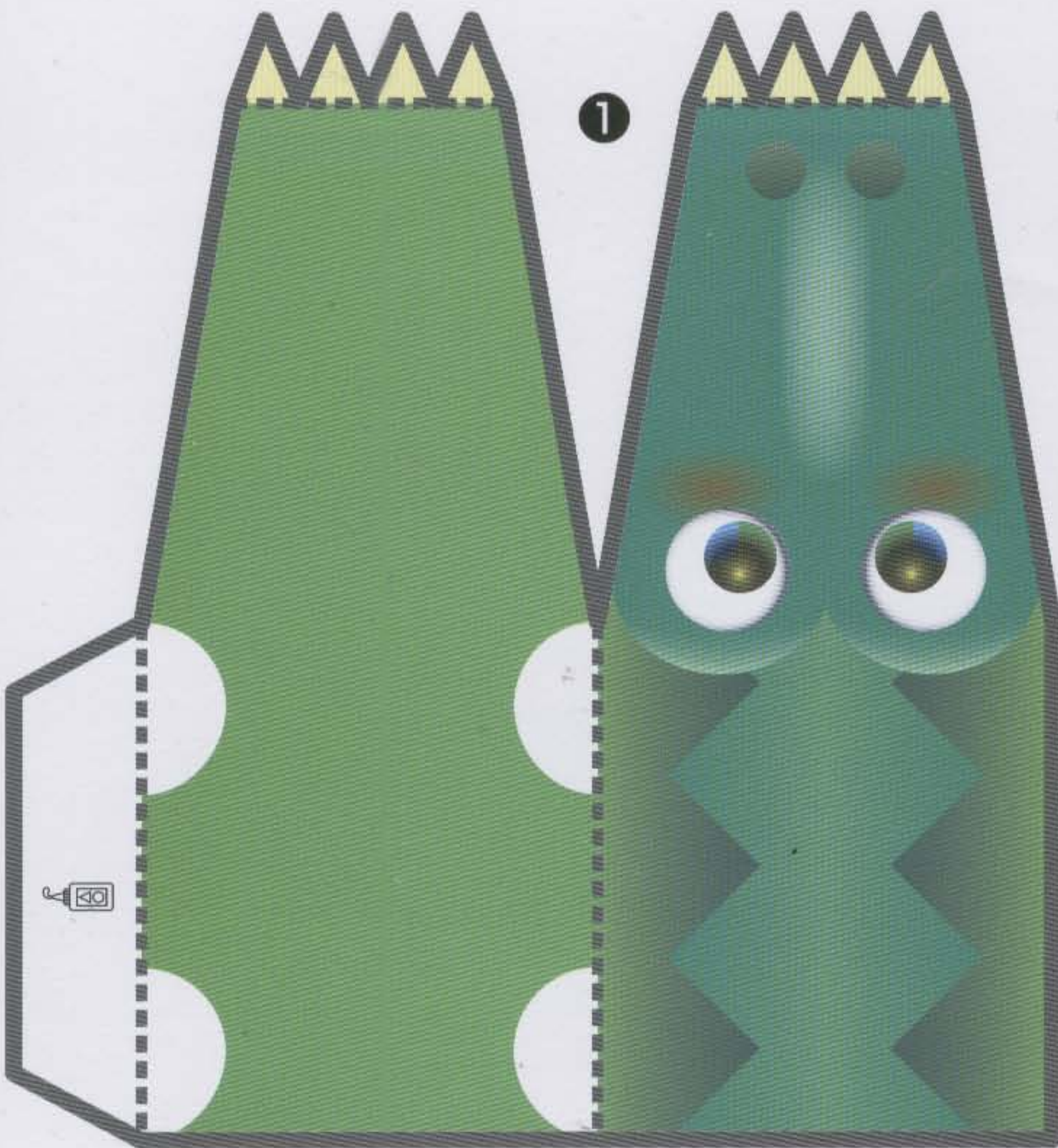

**HOW TO PLAY**

First push the alligator's tail and then pull it. The alligator will bite.

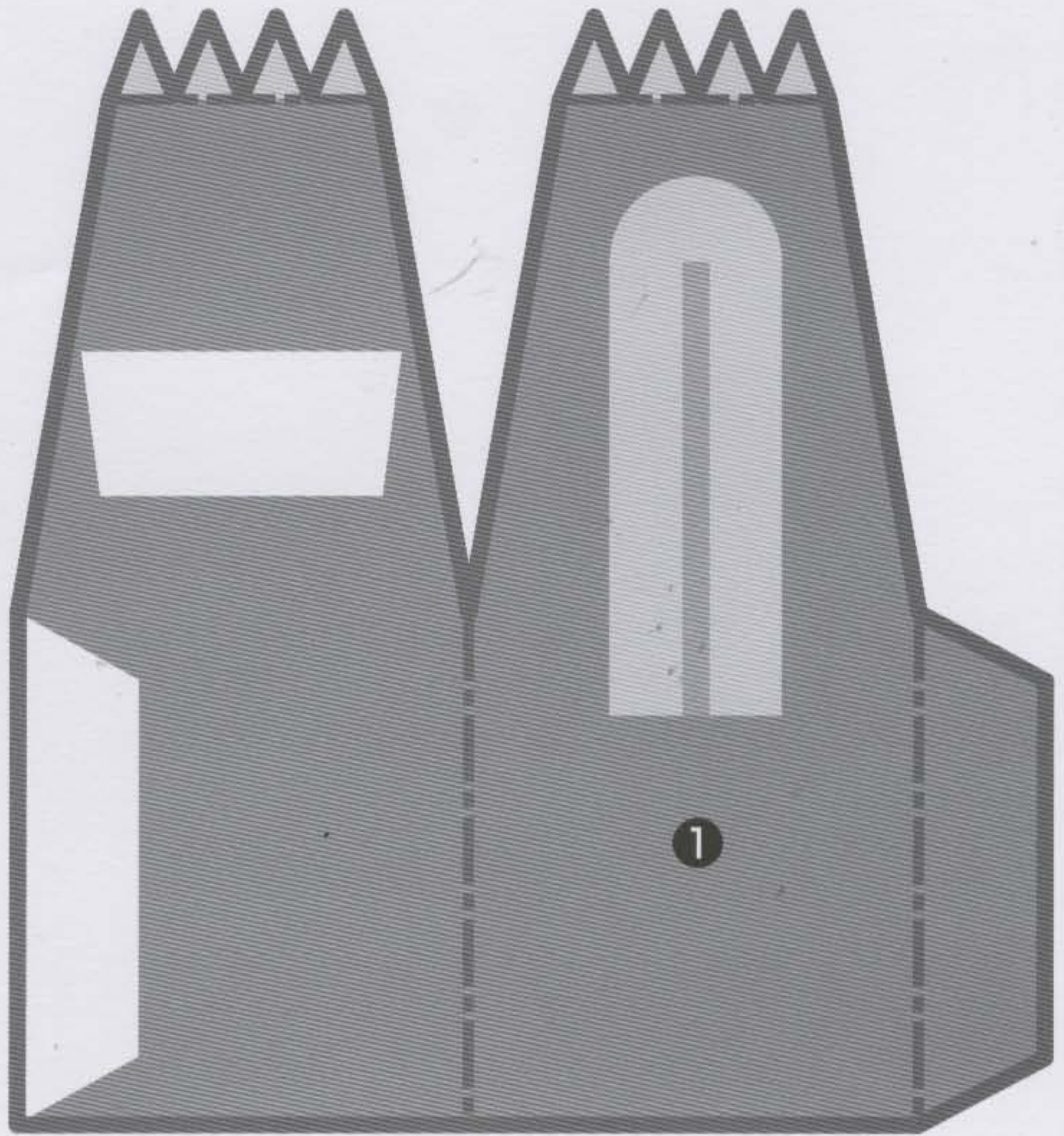

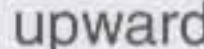

1. Cut along the thick lines .

2. Fold **1** downwards along the dotted lines  and upwards along the dashed lines . Shape **1** into a triangular pyramid and paste the tab to the overlapping adjacent edge. Attach the pyramid to **2** as shown.

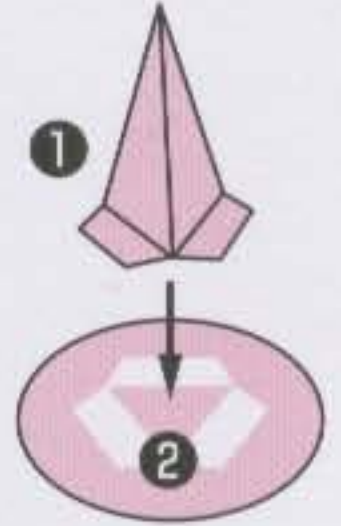

3. Curl **3** into a cone shape. Paste the tab of **3** to the back of the adjacent edge. Fold upwards along the dashed lines  and turn up the flaps.

4. Put **3** on top of **1**.

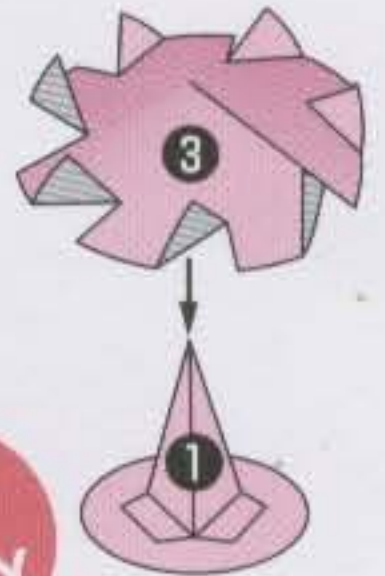

**HOW TO PLAY**

Blow on the top part.

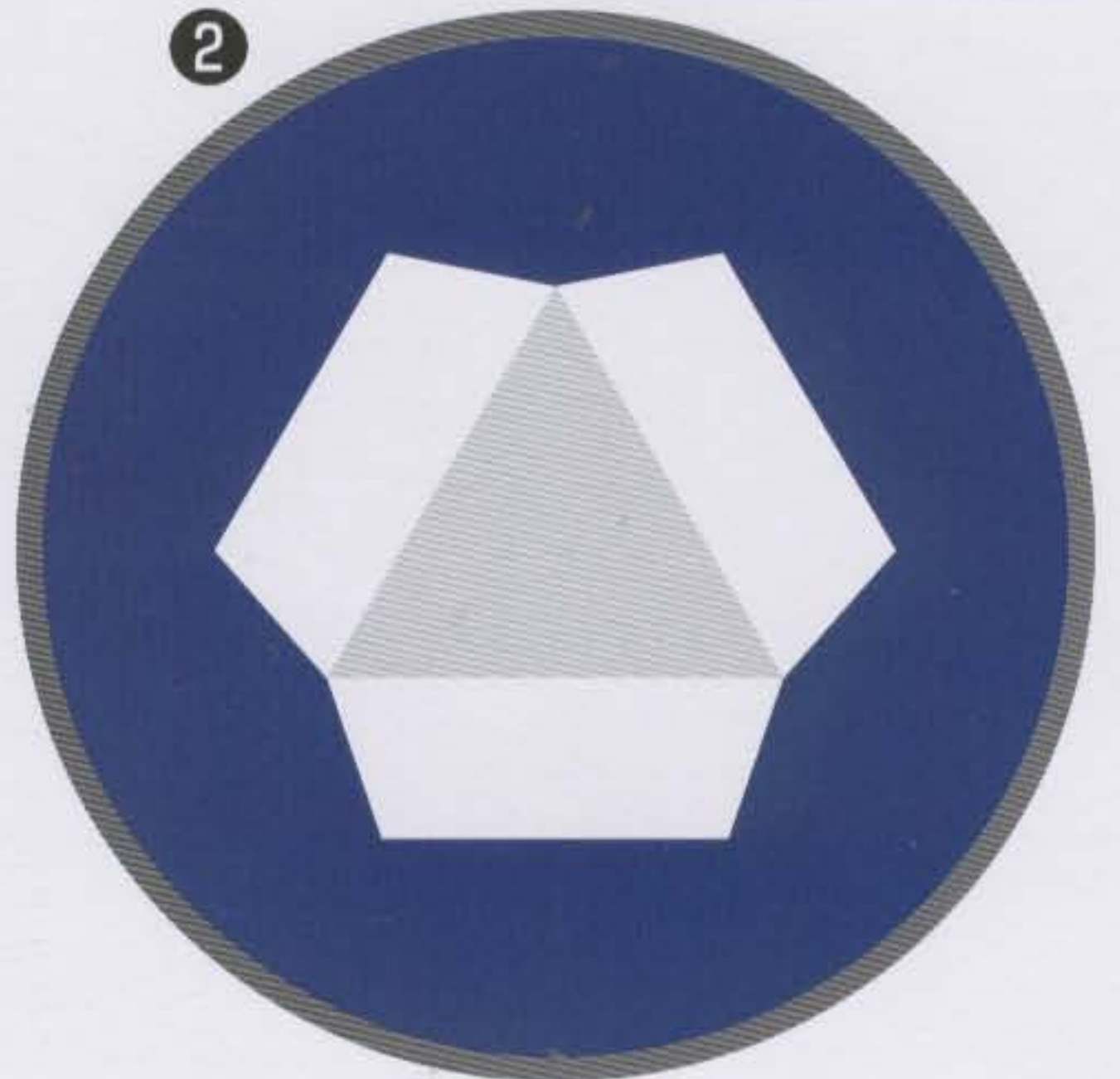
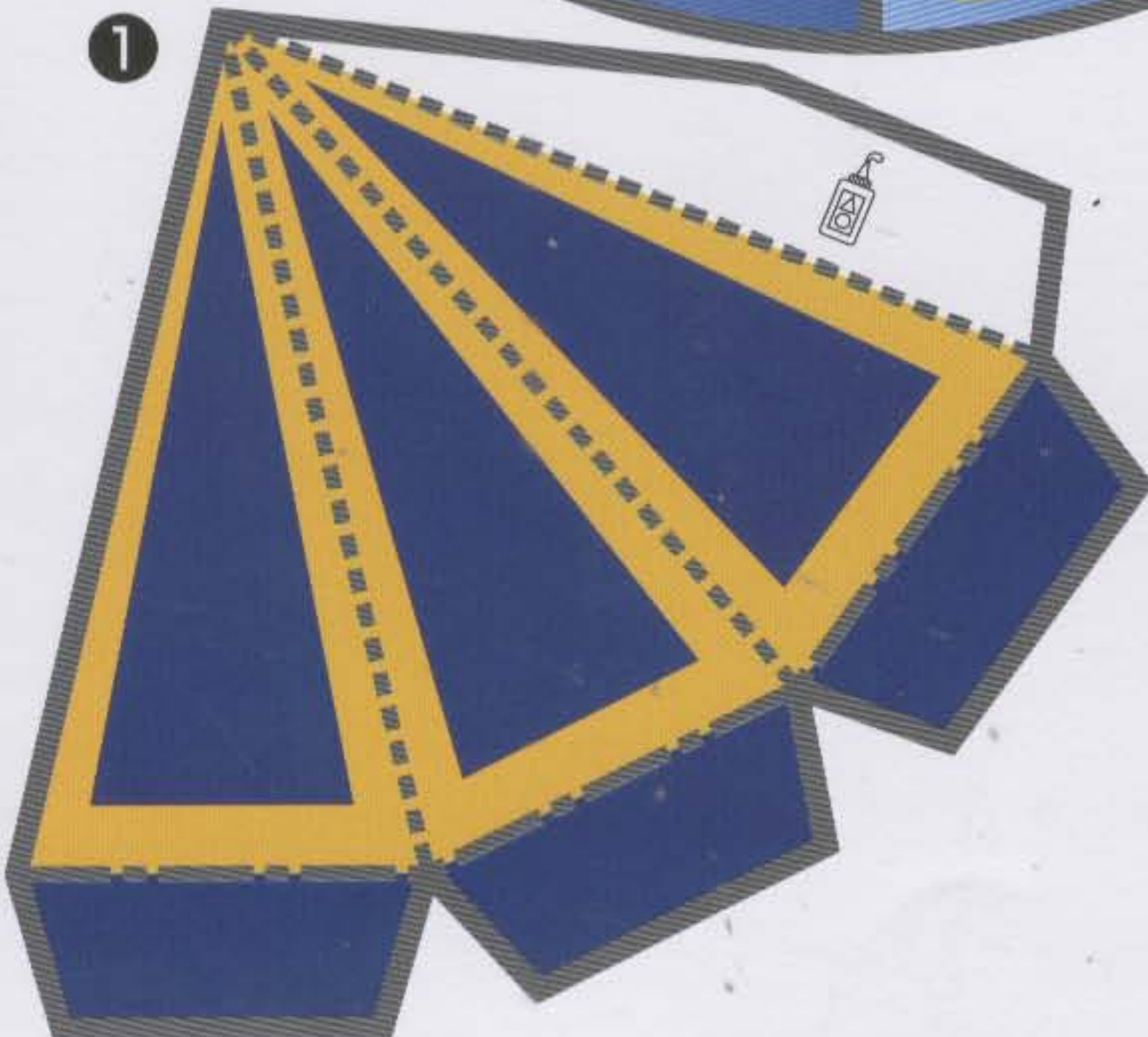
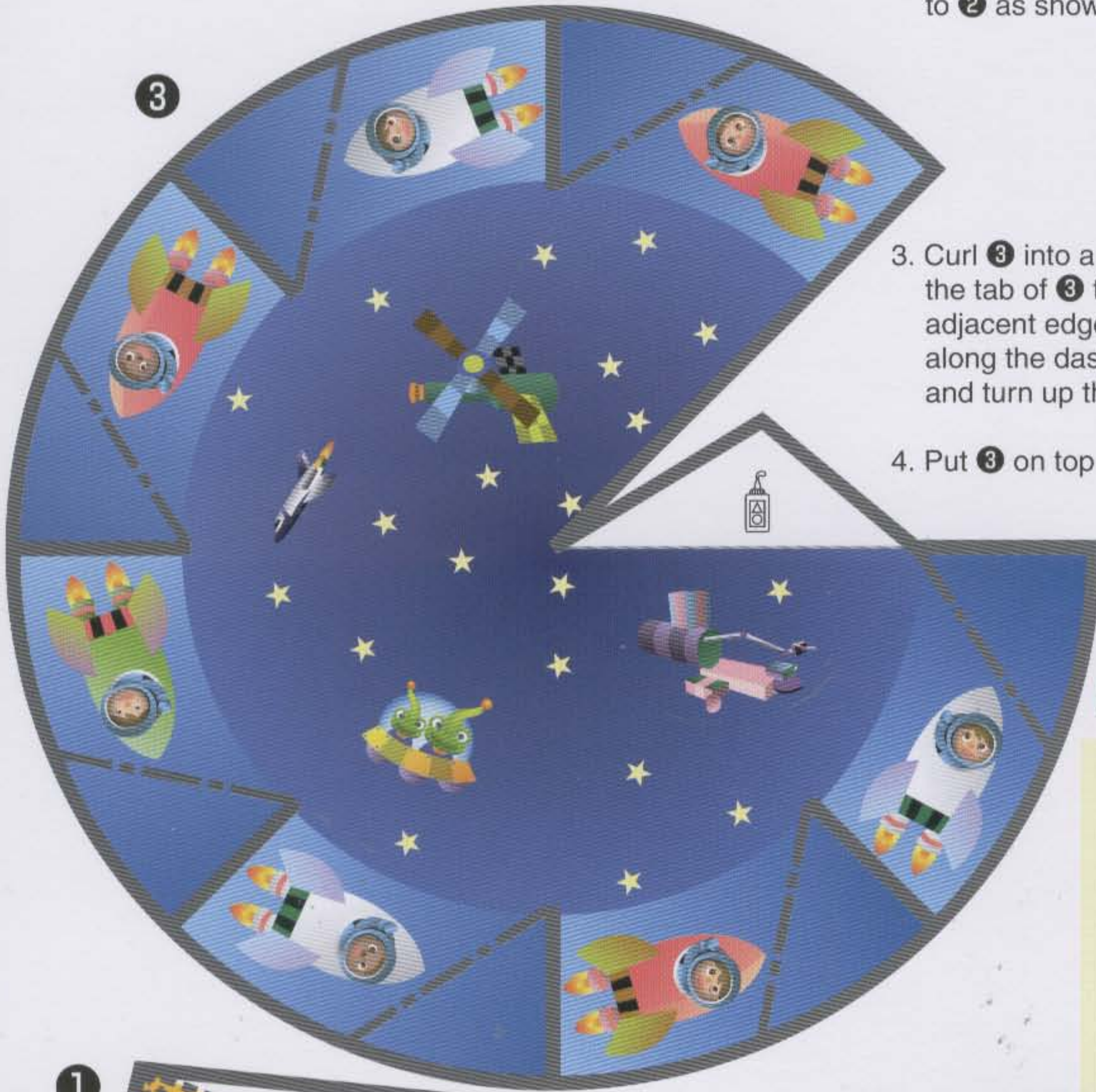

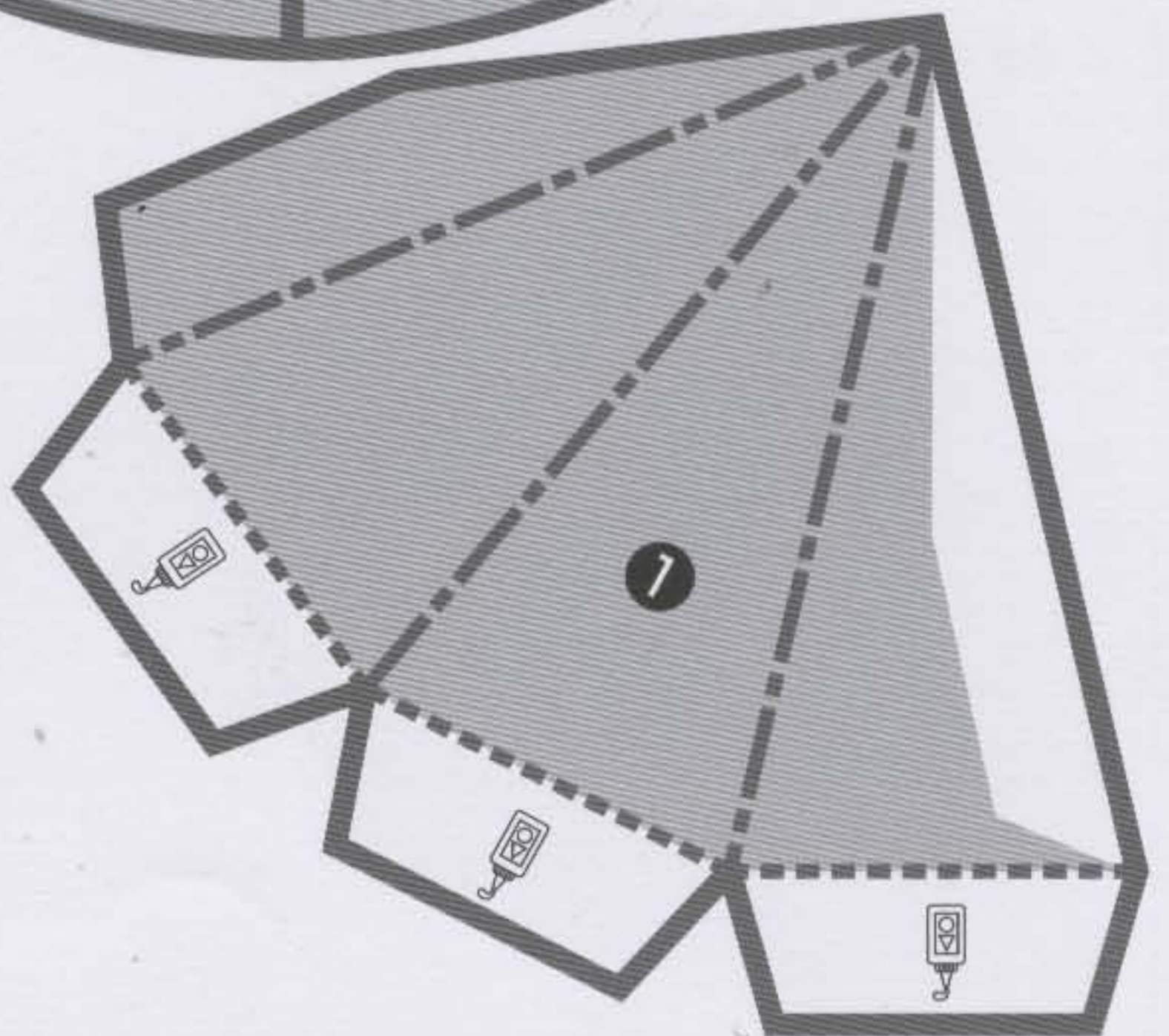
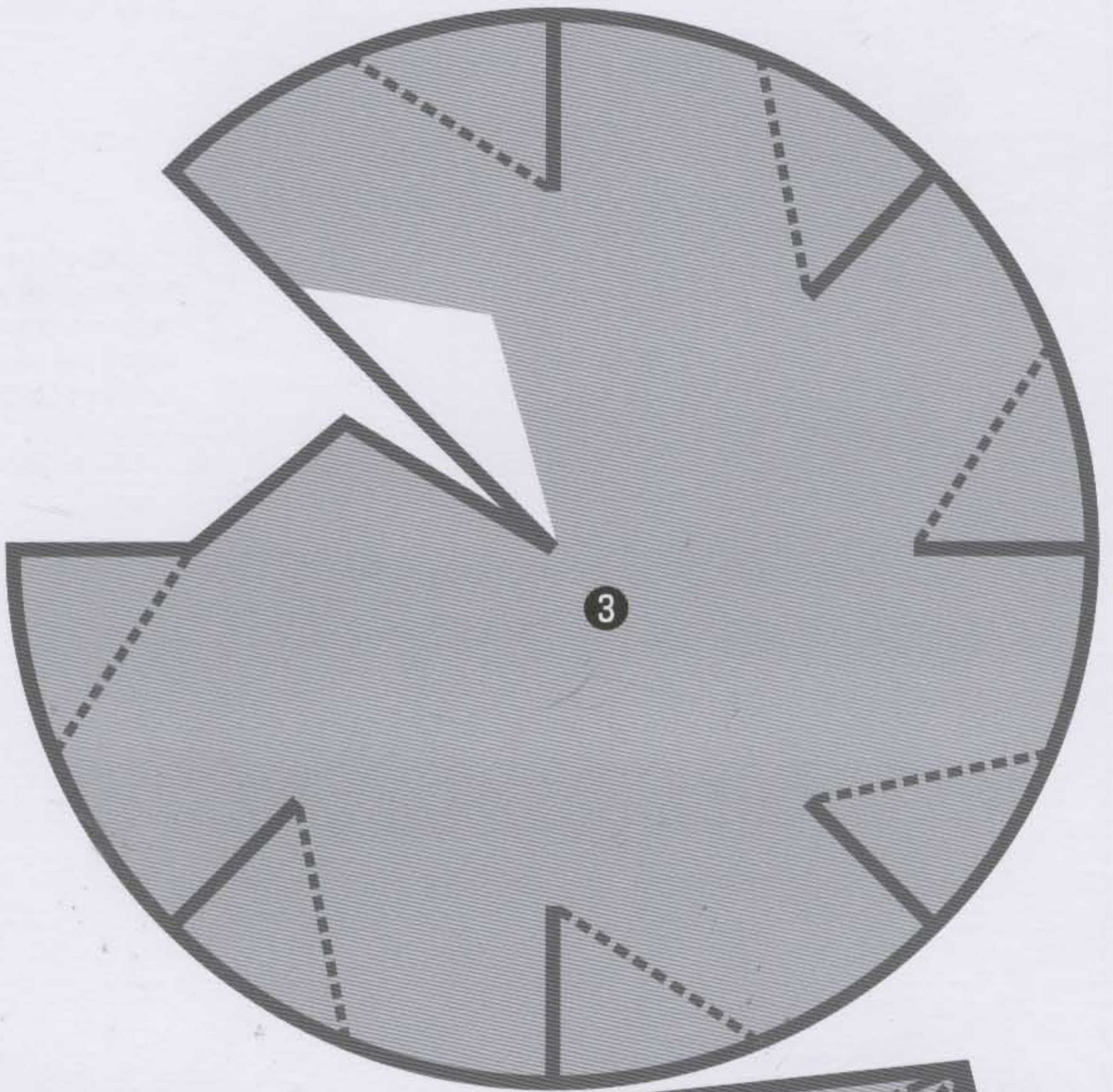
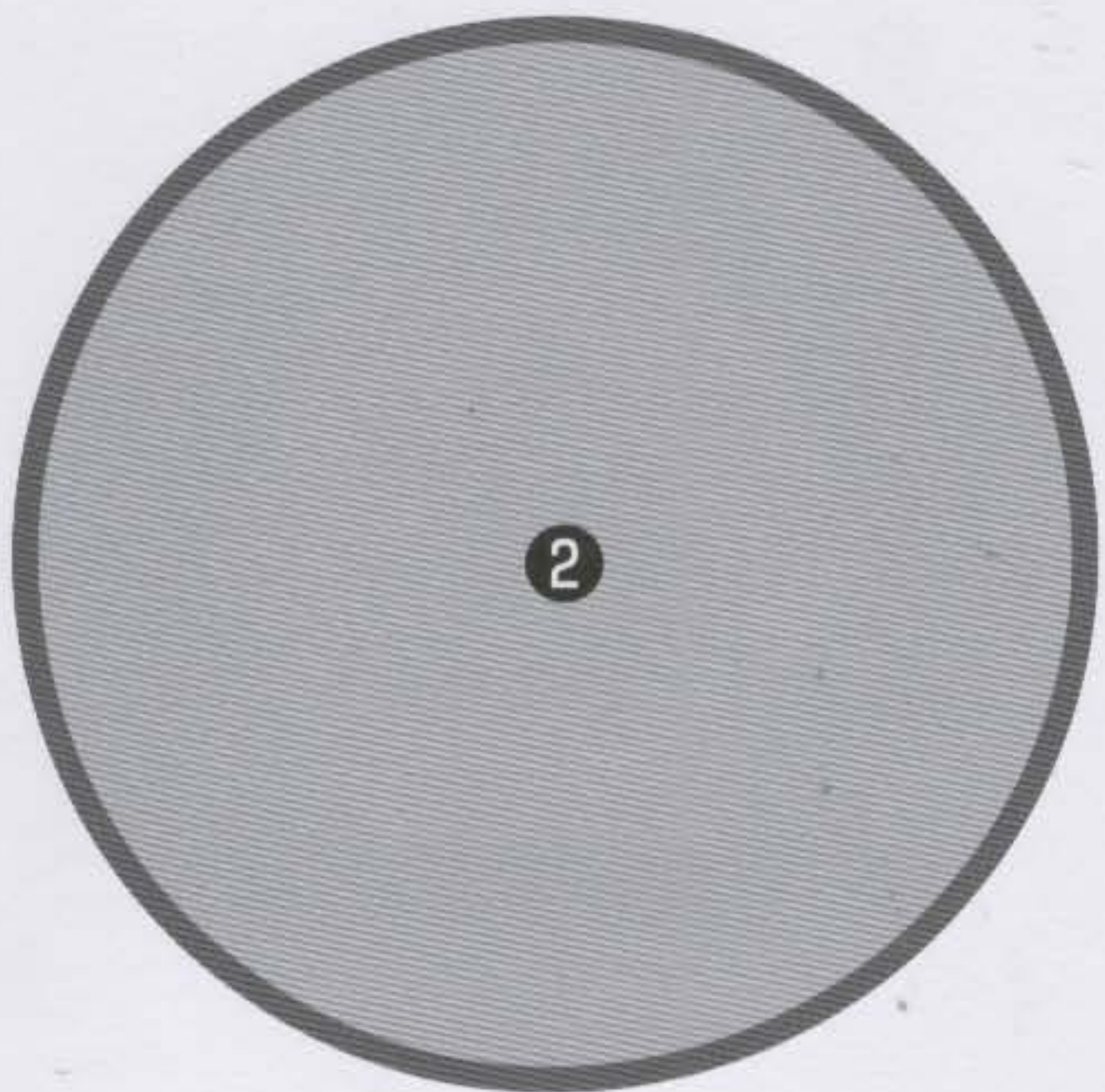



## Pancake Flipper

1. Cut along the thick lines .

2. Form two connecting cones with **1** by pasting the fan-shaped tabs onto the adjacent edges. Put a string between the cones and paste the flap onto the facing side. Tie the end of the string to itself.

3. Fold **2** in half and paste. Make a cone with **3**. Attach **2** to **3**.

4. Tie the other end of the string to **2**.

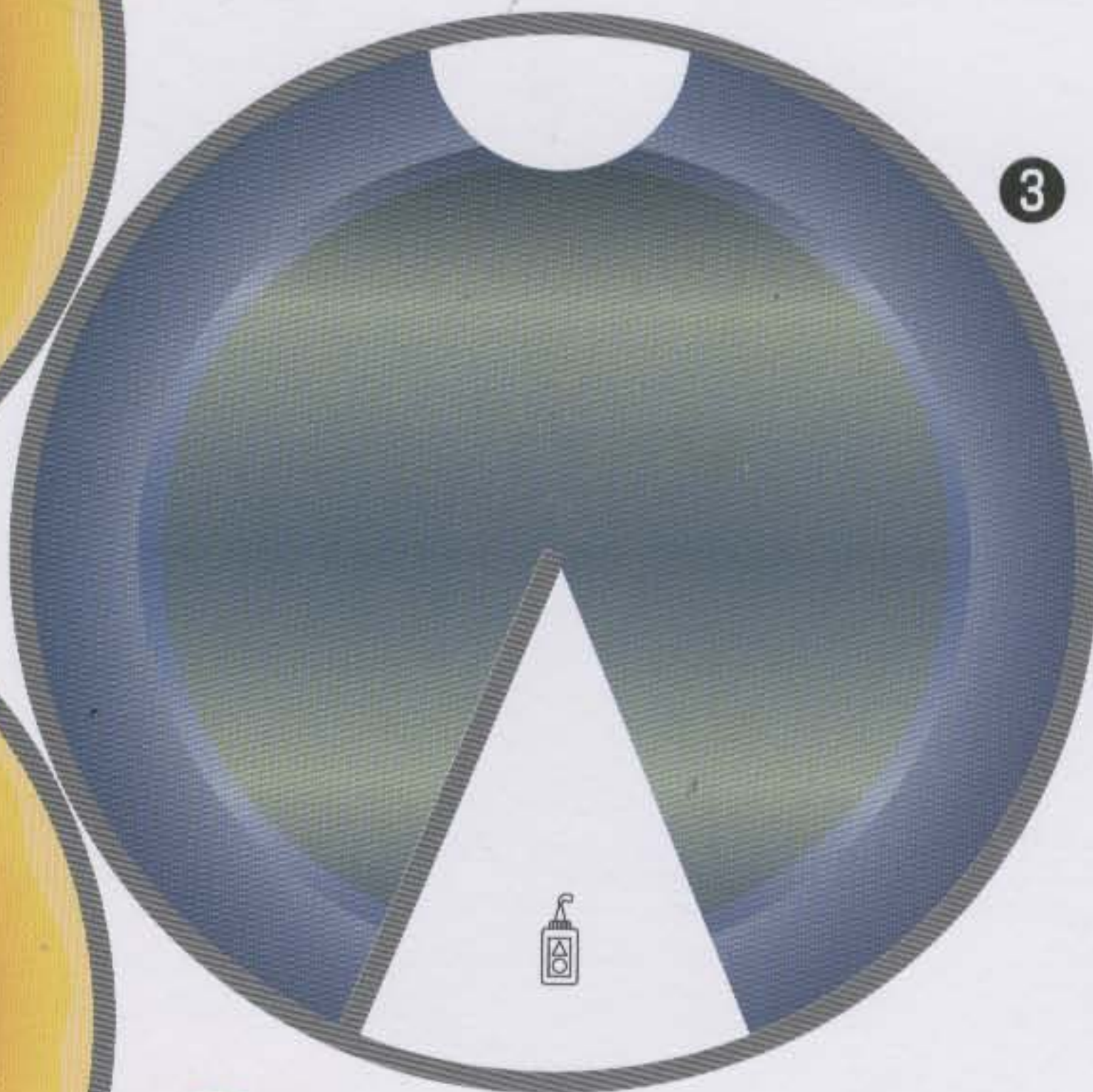
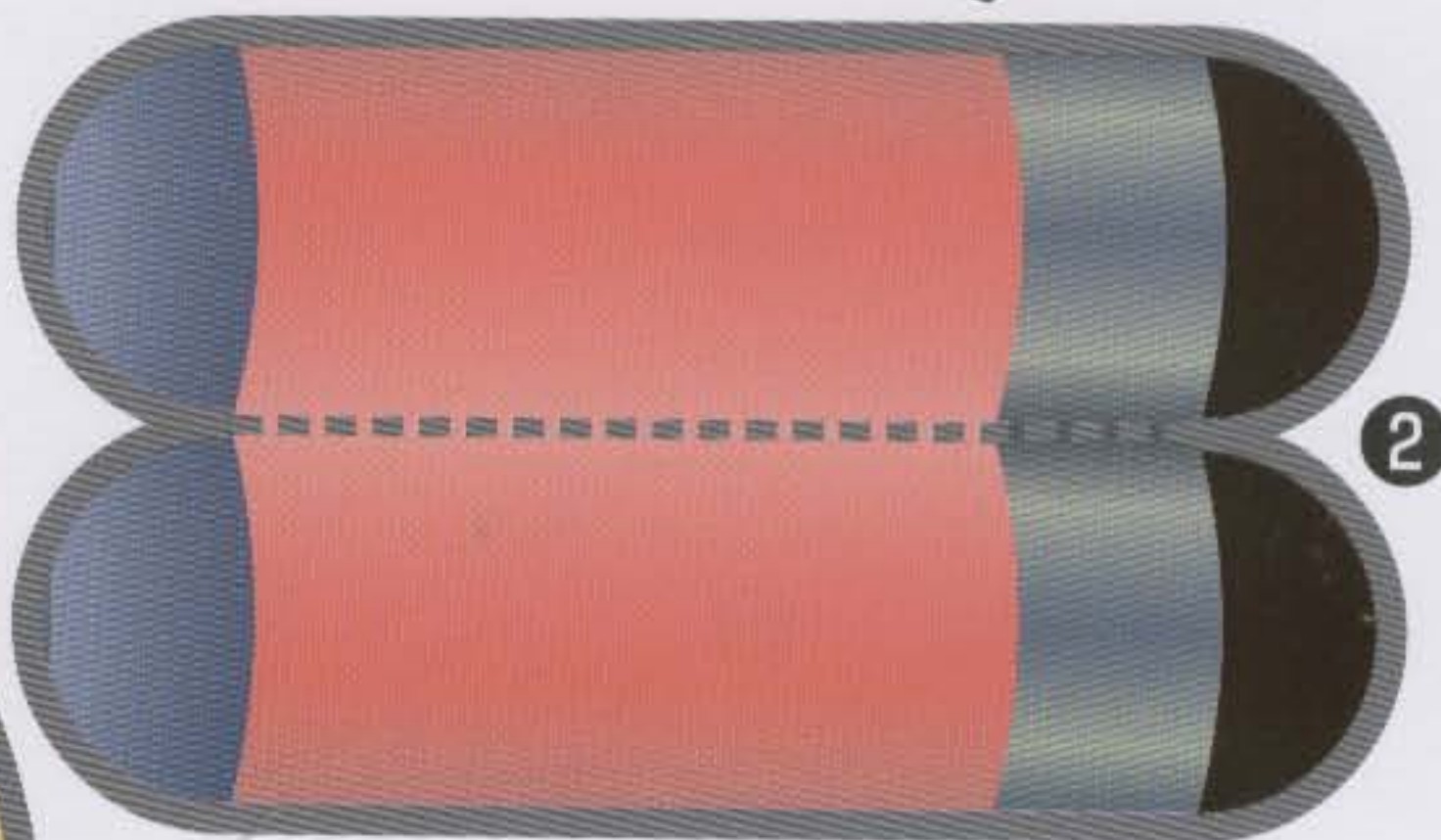
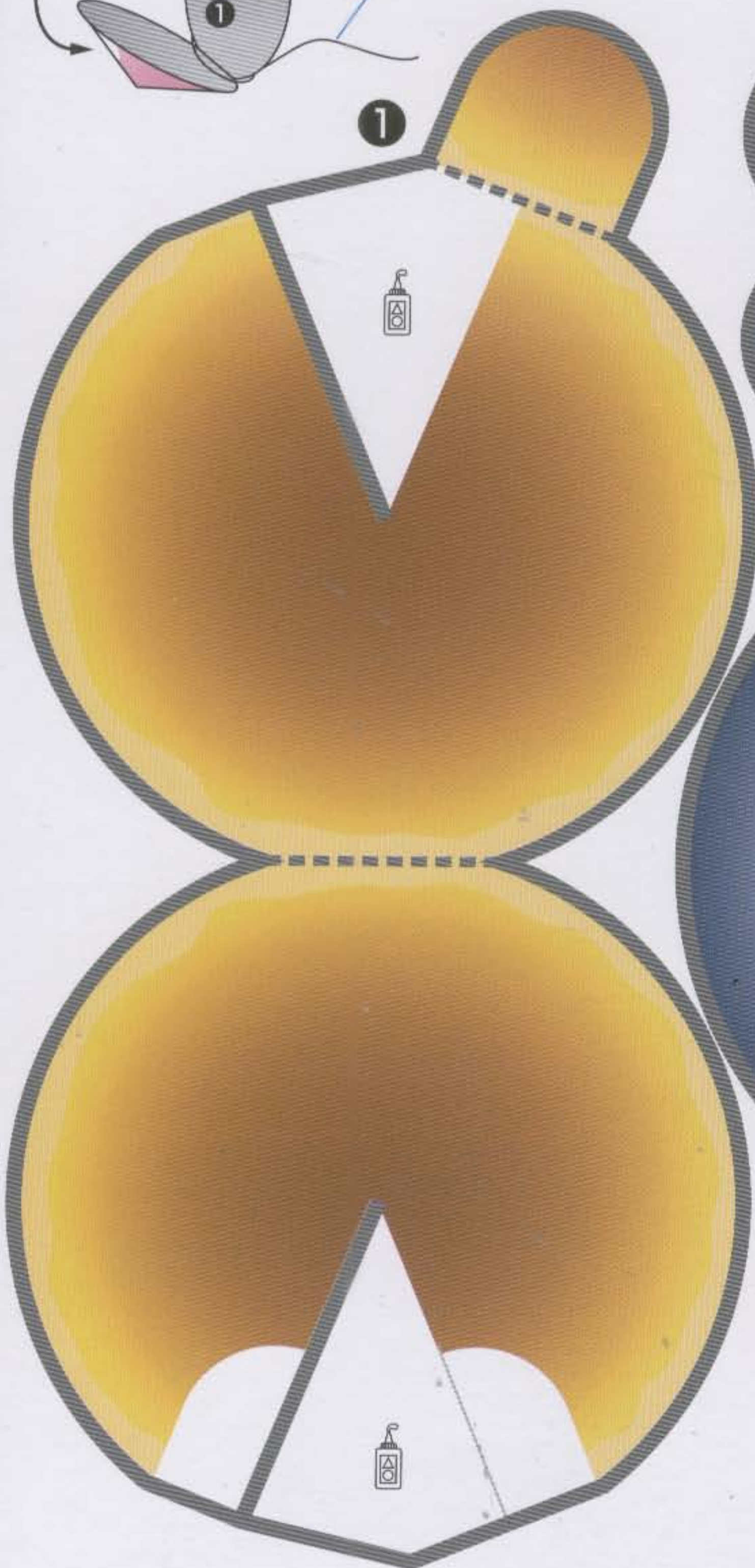
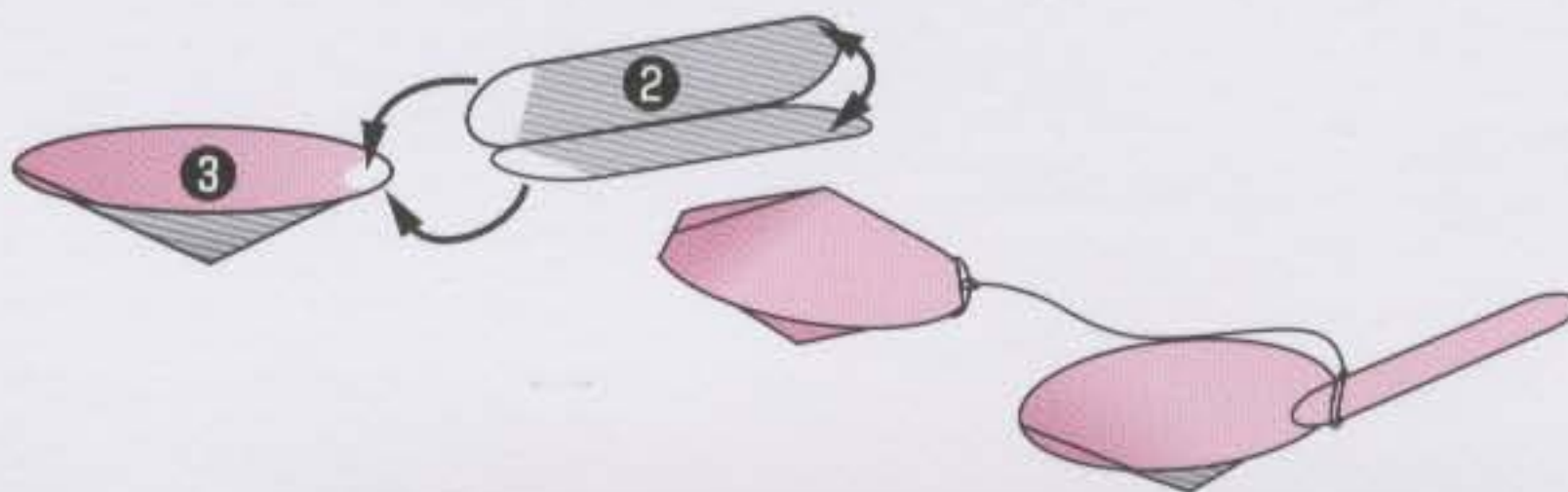
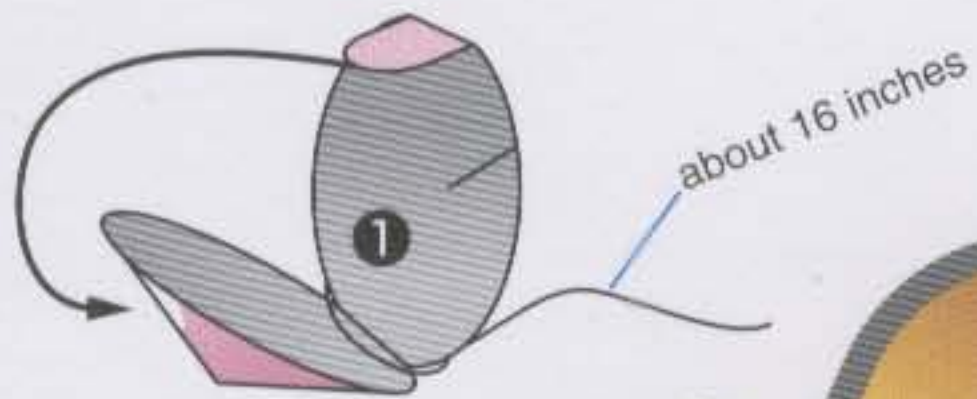

\*Parents, please cut along this line for your child.

### HOW TO PLAY

Toss the pancake and catch it with the pan.

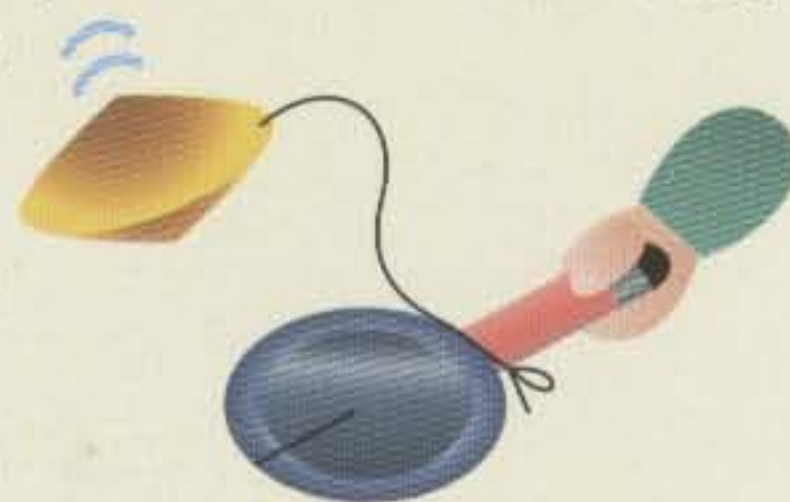

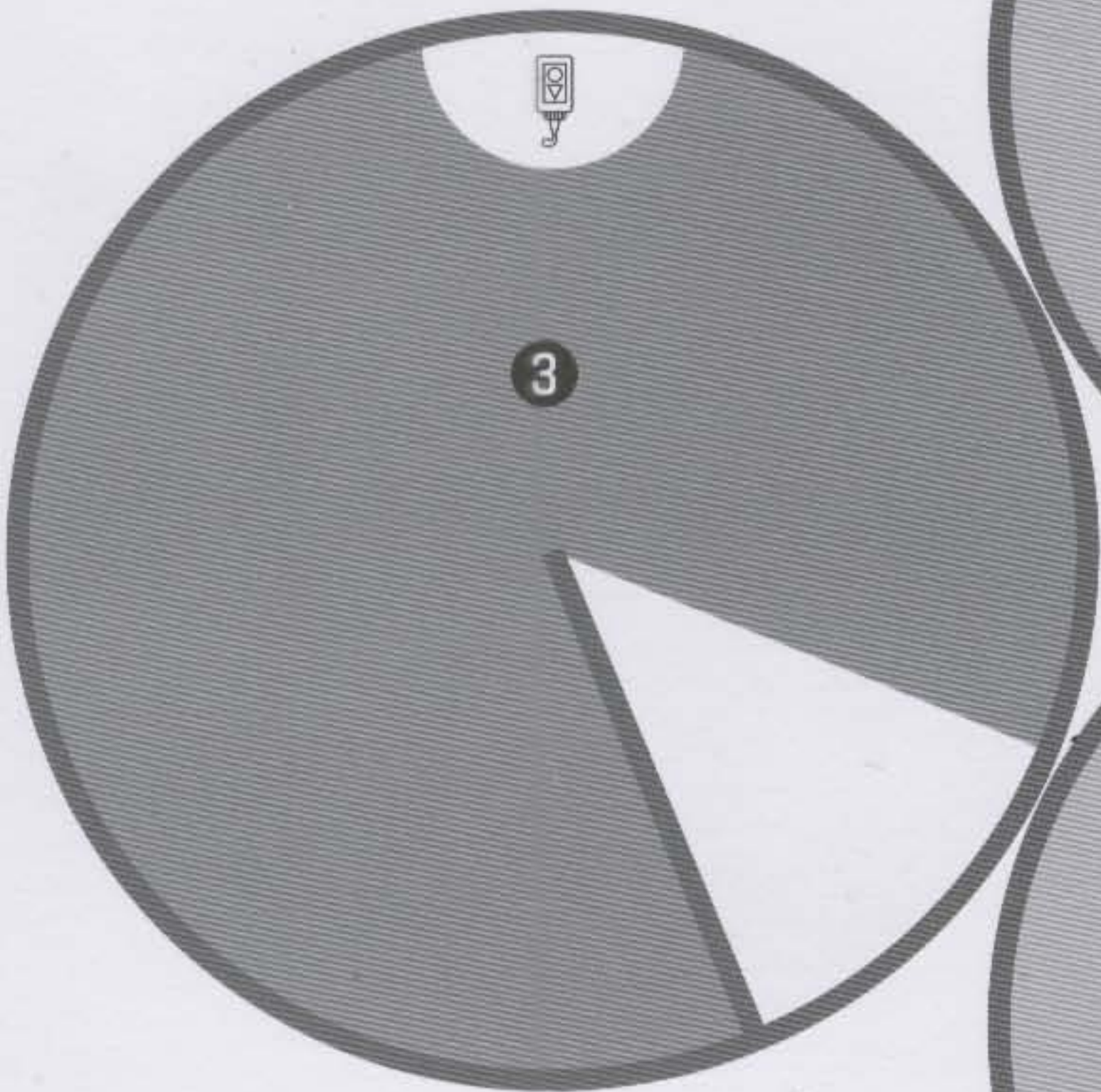
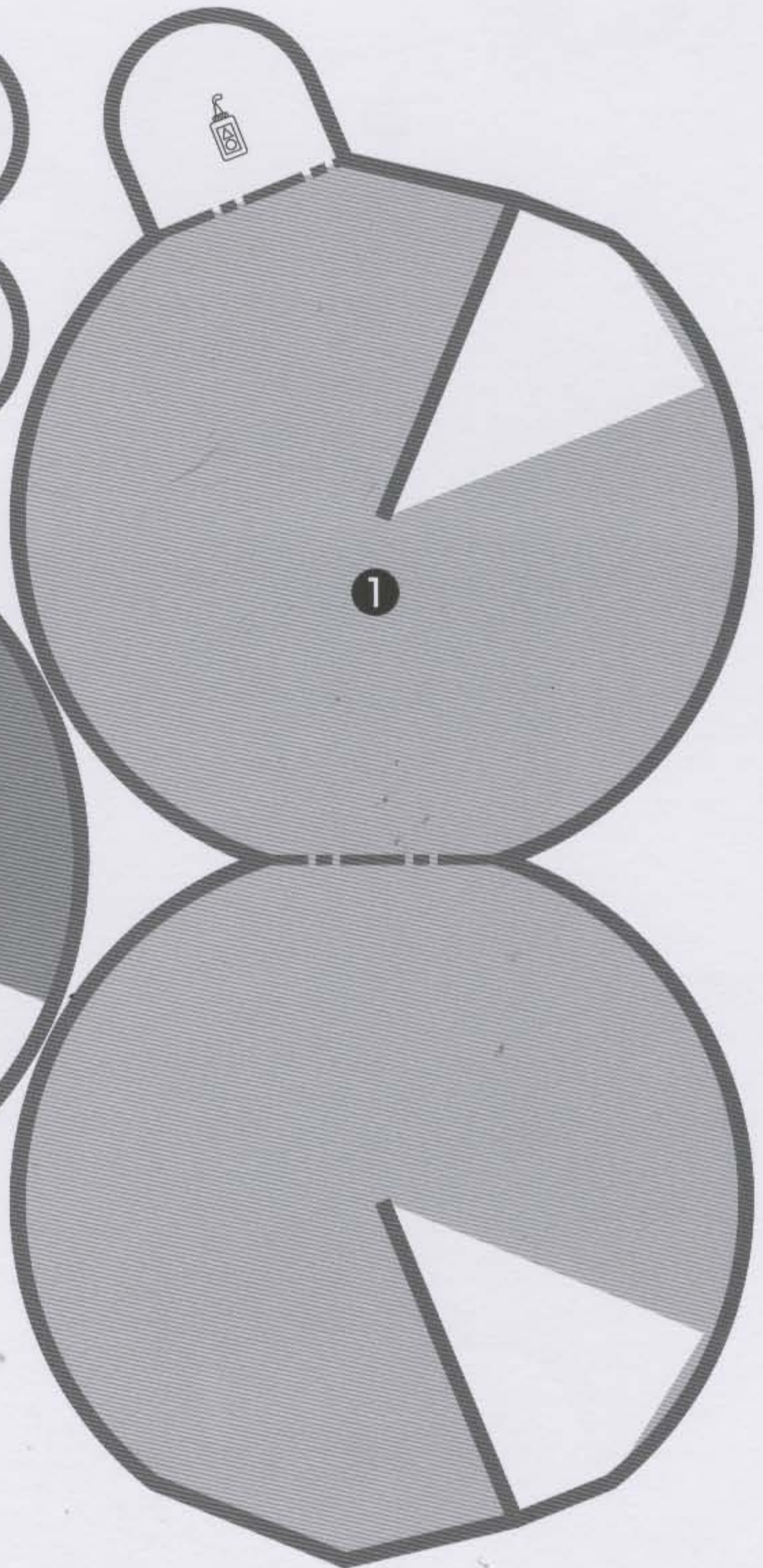
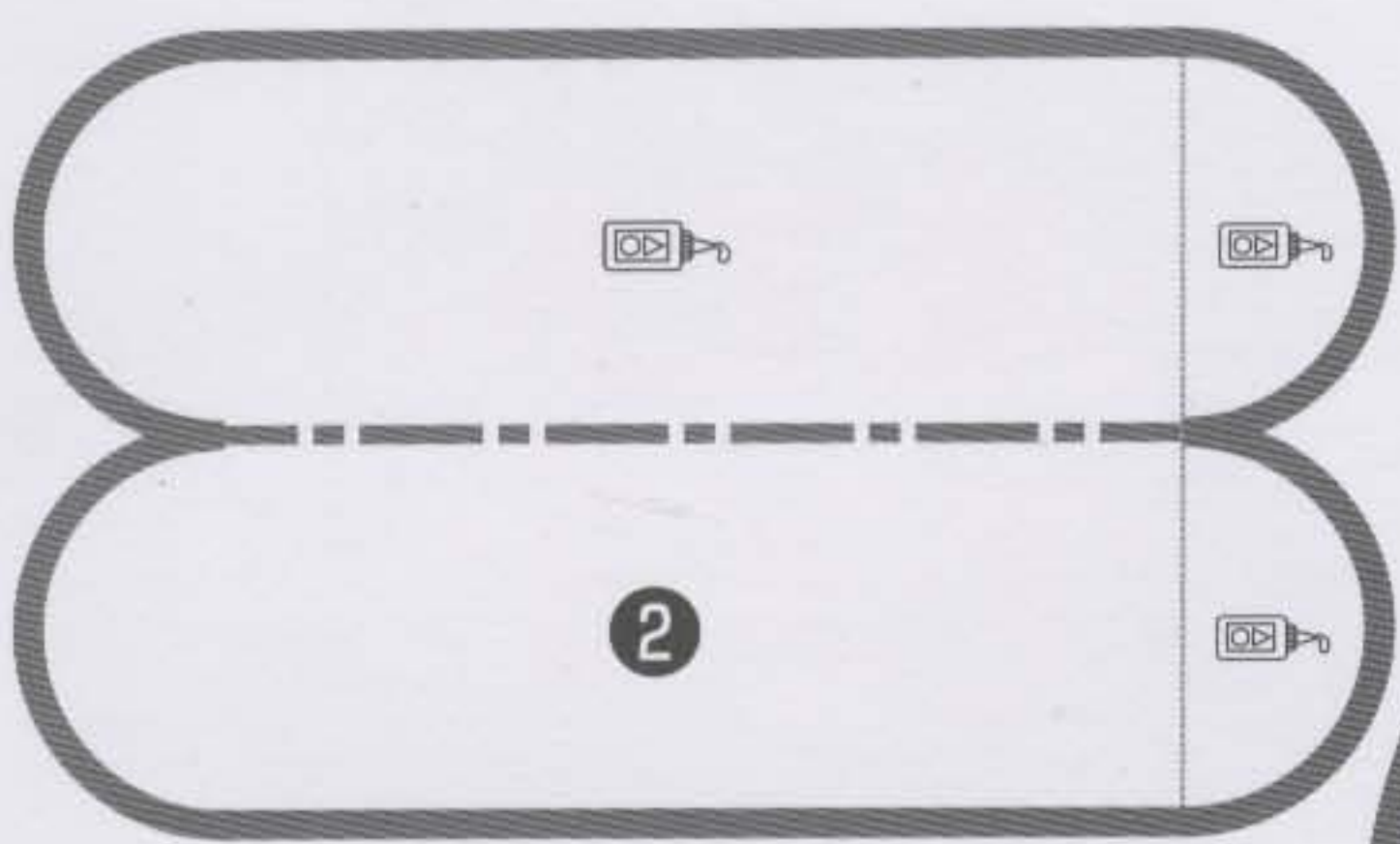

## Flying Bird

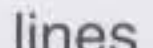
1. Cut along the thick lines .
2. Fold ① downwards along the dotted lines . Paste the tab onto the back of the other edge.
3. Attach ① to the back of ②.
4. Put two pieces of string through ①. Tie the strings together and hang the bird up.

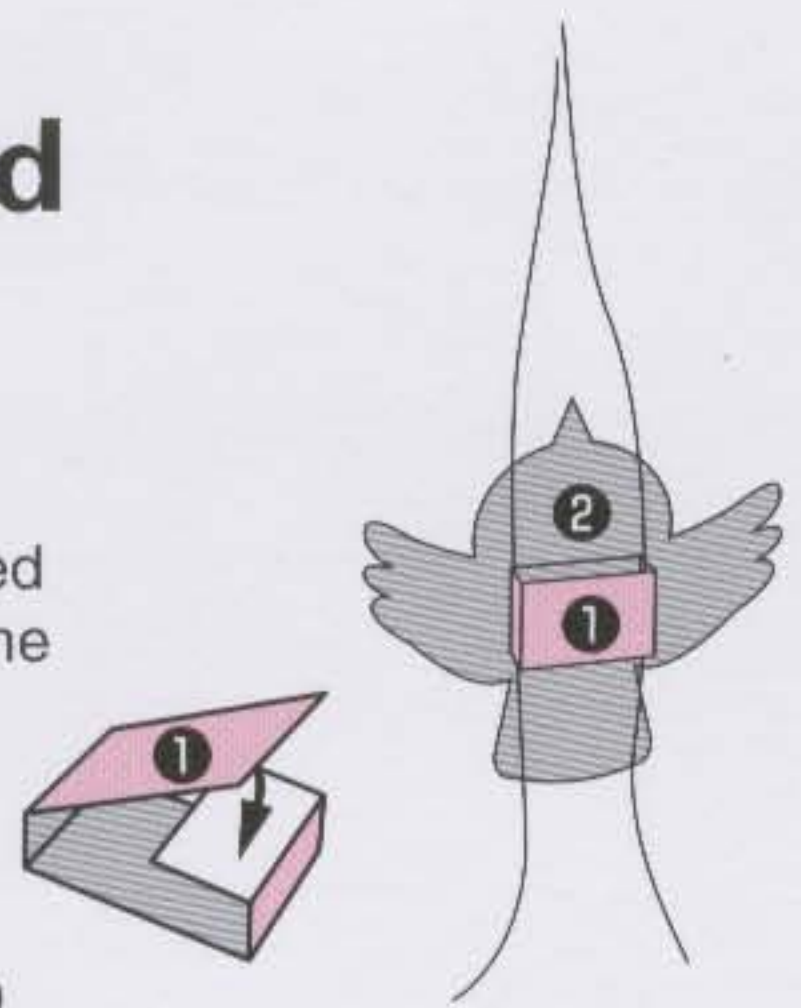

**HOW TO PLAY**

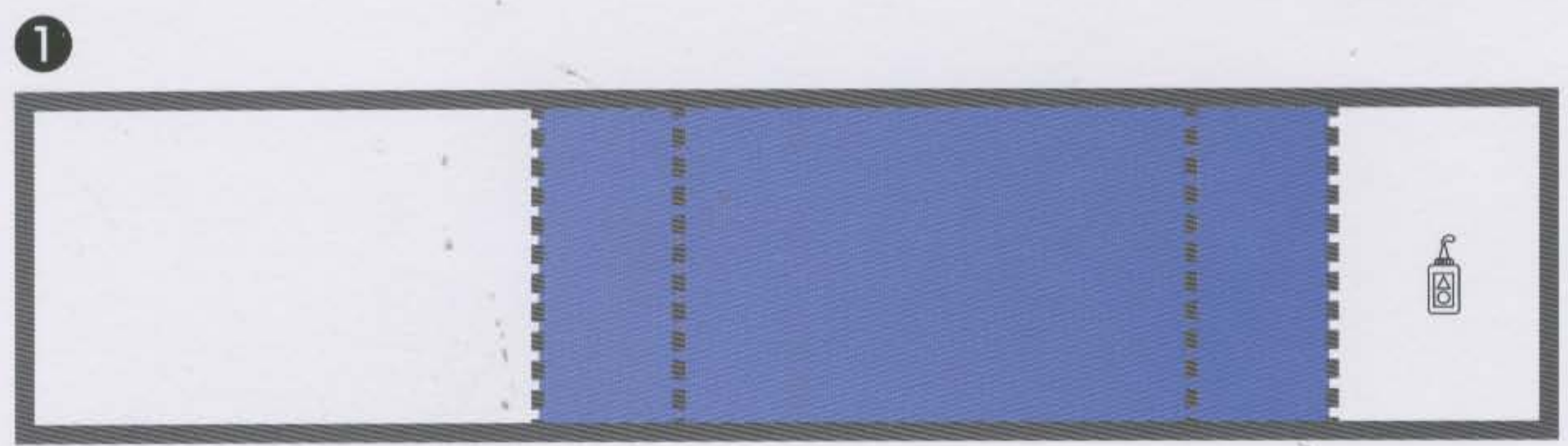

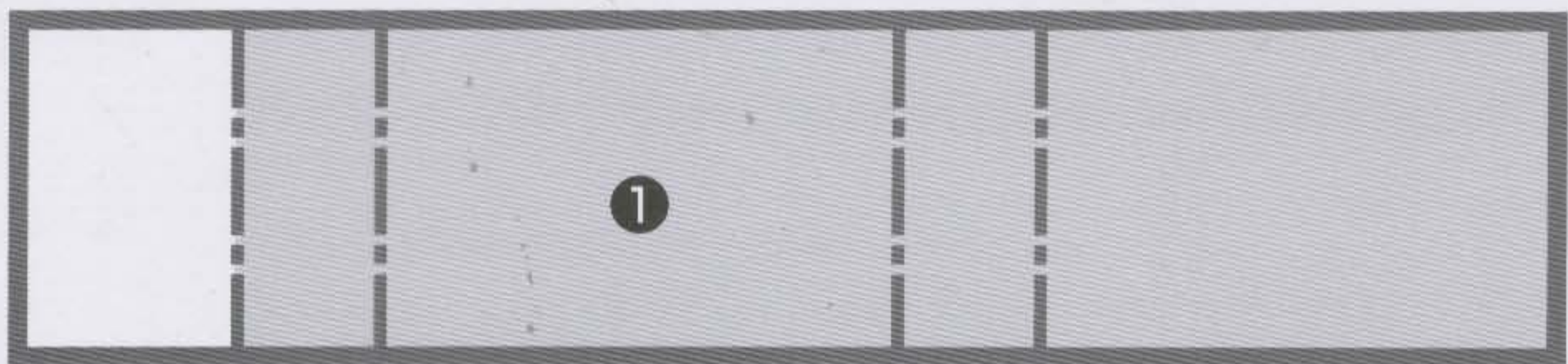
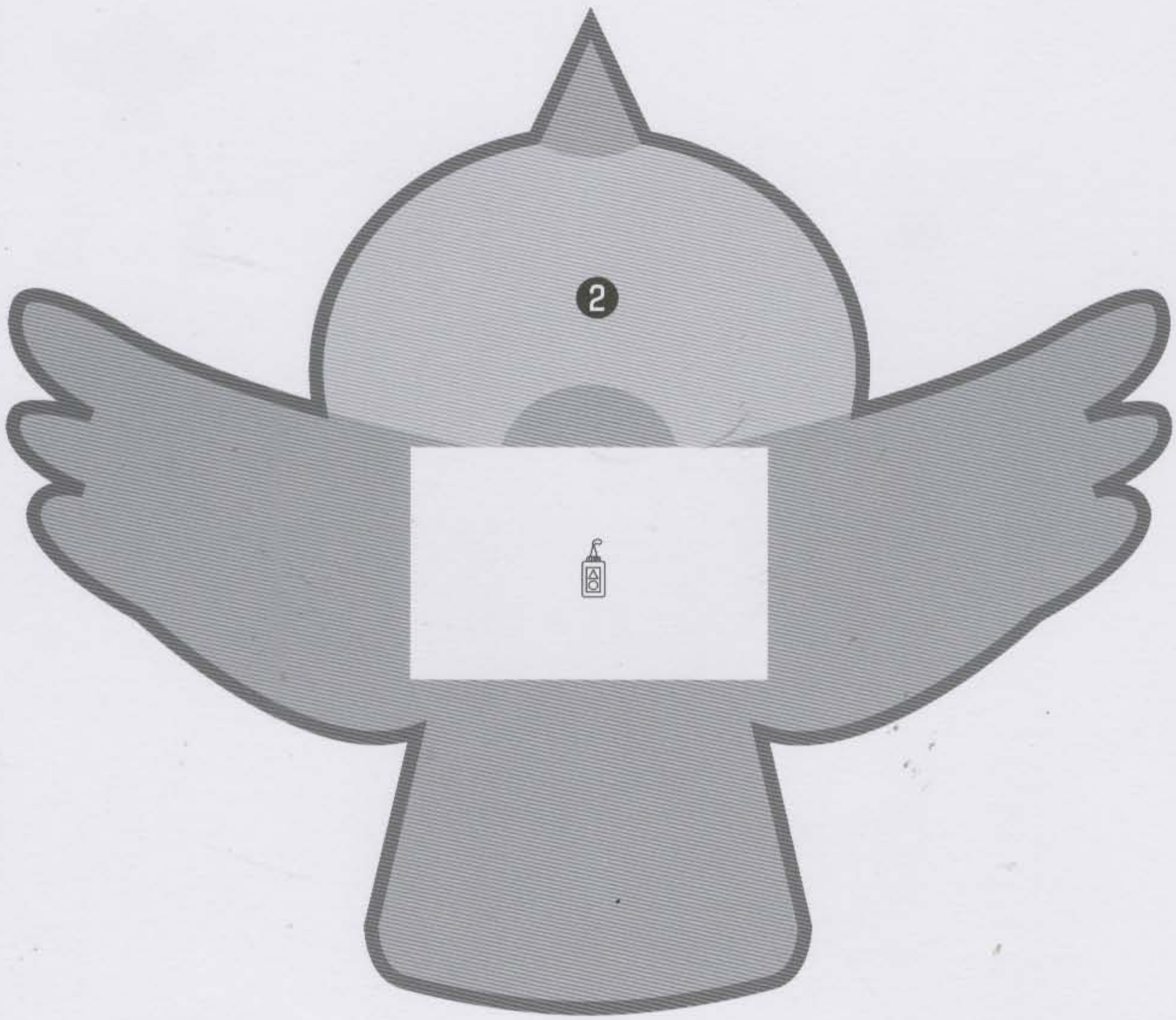

\*Parents, please cut along this line for your child.



# 34

## Buzzing Bee

1. Cut along the thick lines .

2. Fold **2**, **3**, and **4** downwards along the dotted lines  and upwards along the dashed line .

3. Attach all parts as shown on the right.

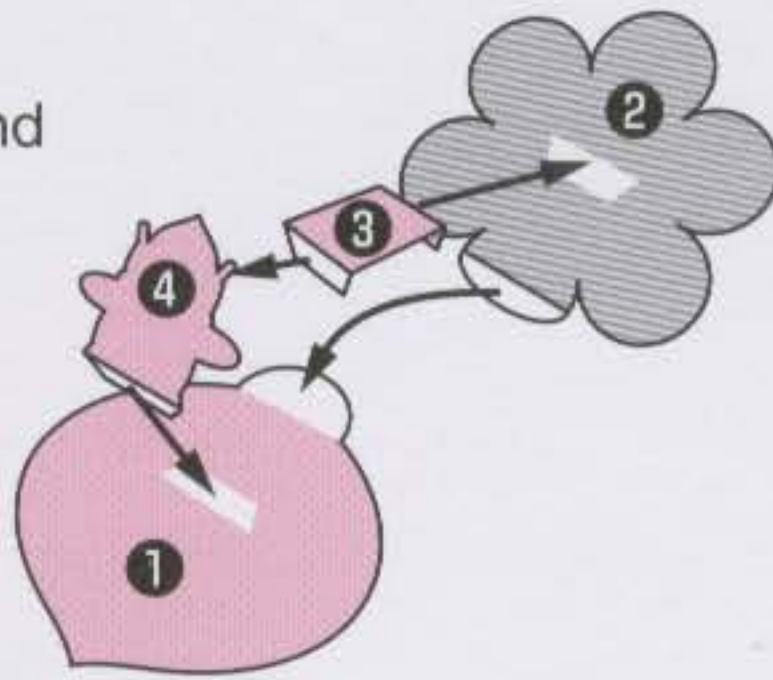

**HOW TO PLAY**

Lift the flower. The bee will pop out.

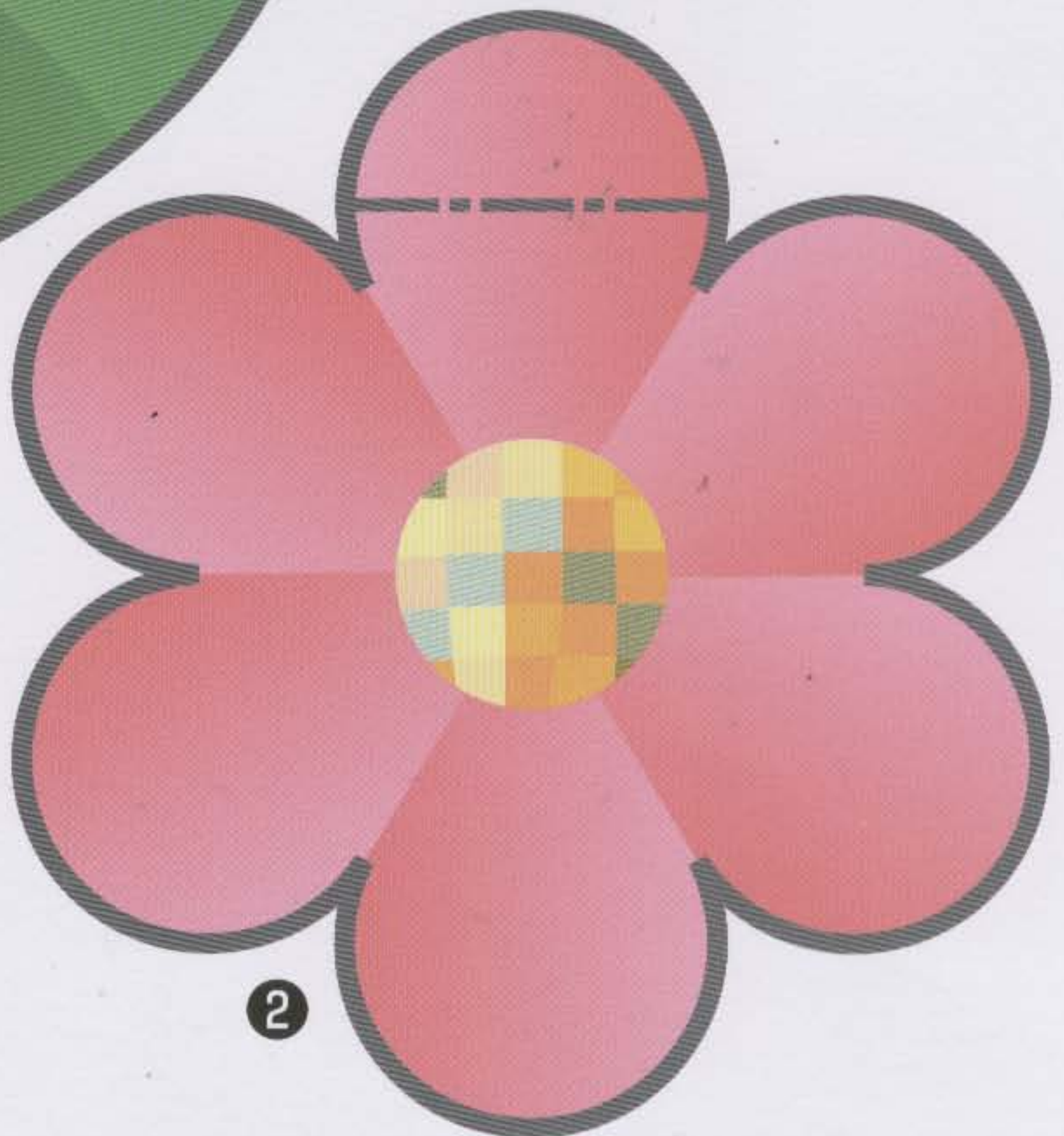

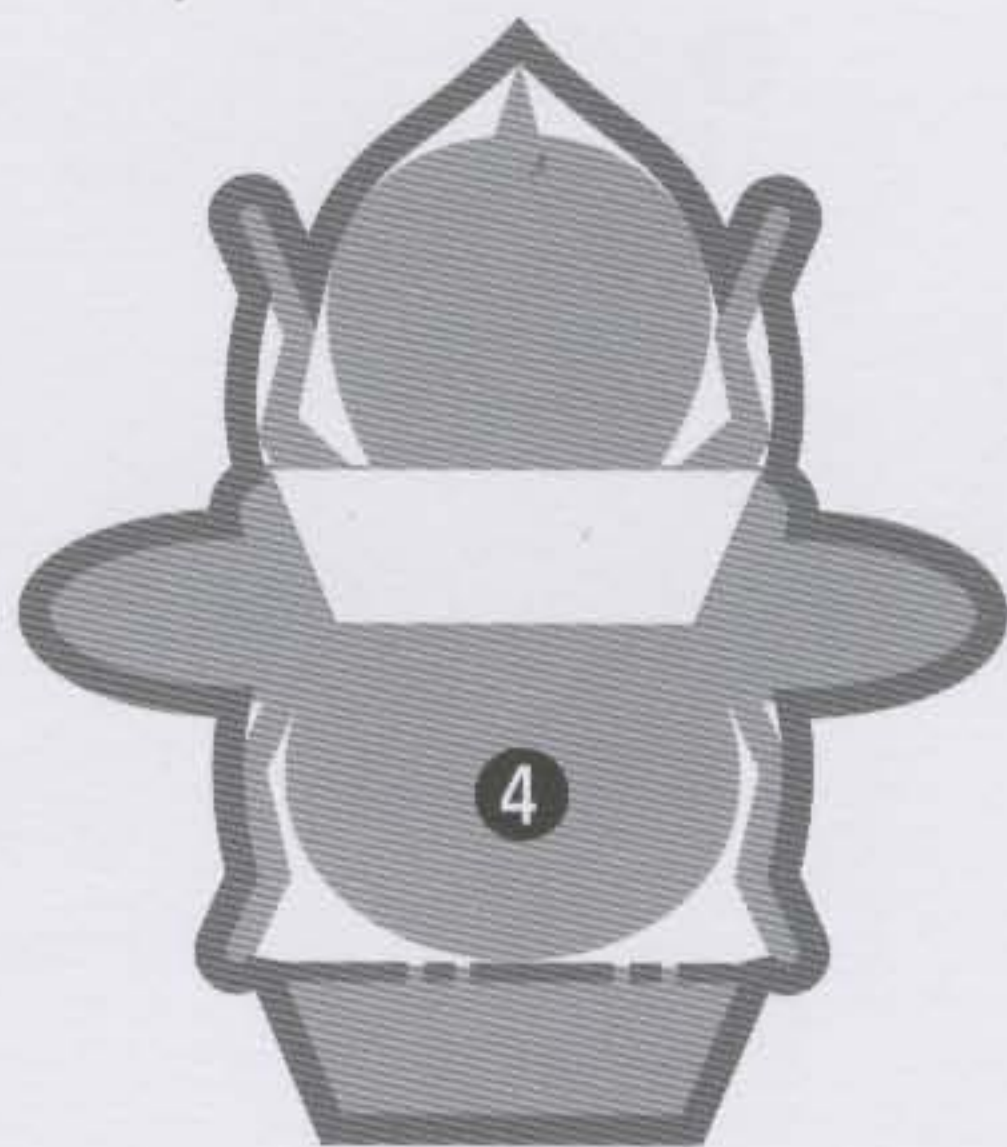
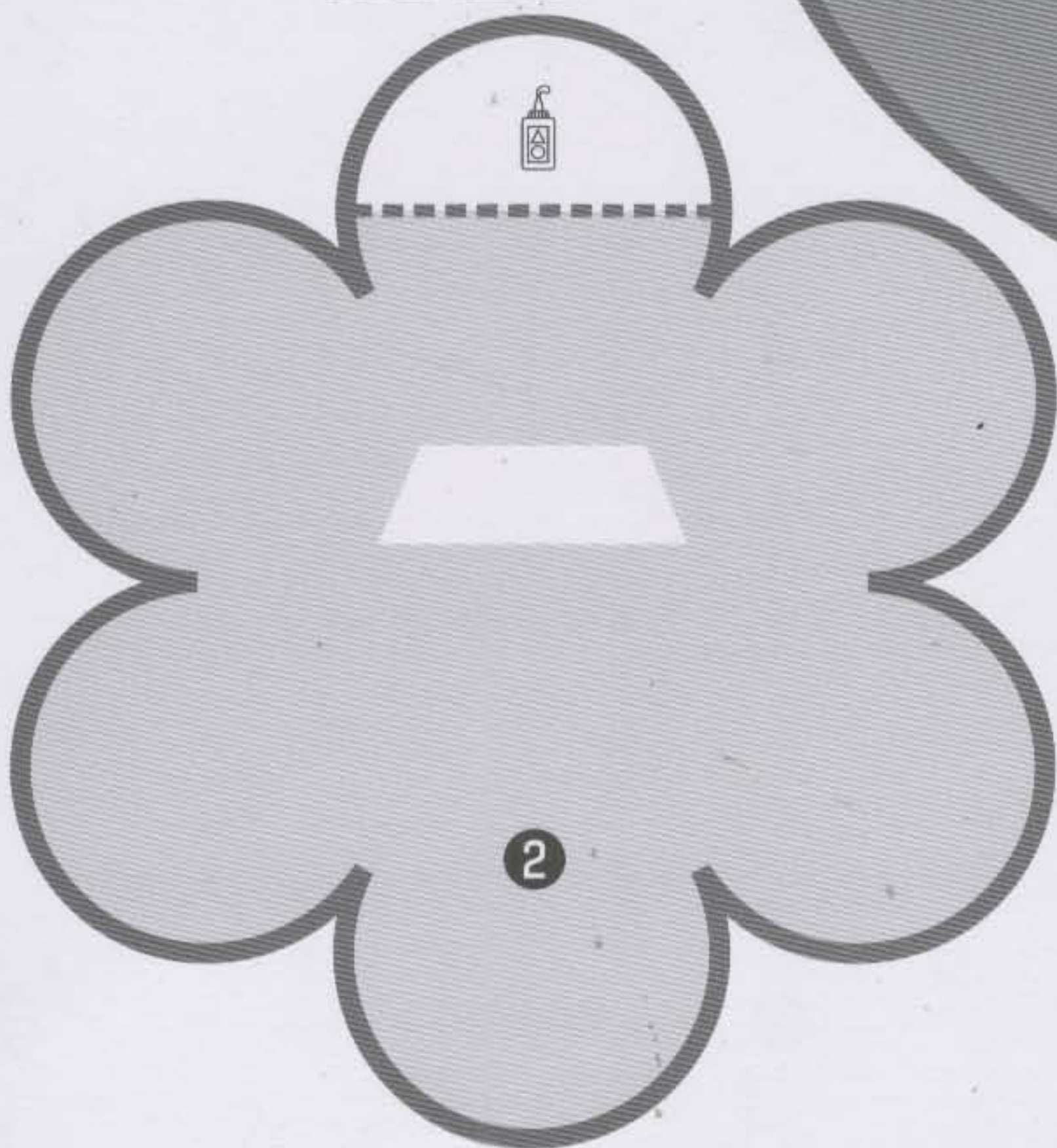
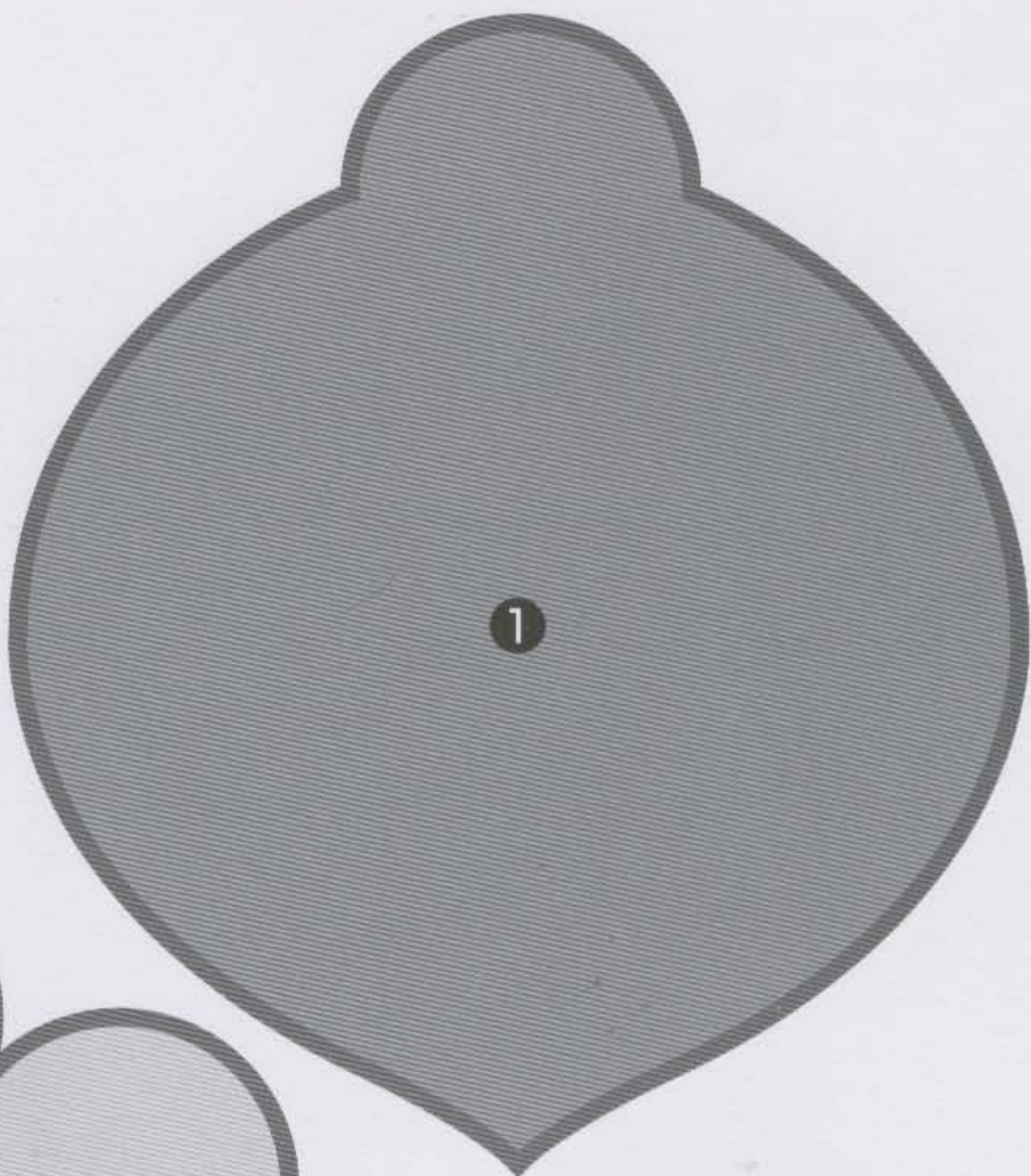

## Hiding Frog

**To parents**  
If your child has difficulty pasting accurately, offer to help him or her paste the parts in the correct places.

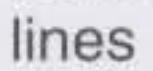
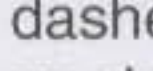
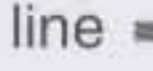
1. Cut along the thick lines .
2. Fold ① in half.
3. Fold ② downwards along the dotted lines  and upwards along the dashed line . Paste it onto ① as shown on the right.
4. Fold ③ upwards along the dashed line  and paste it onto ②.

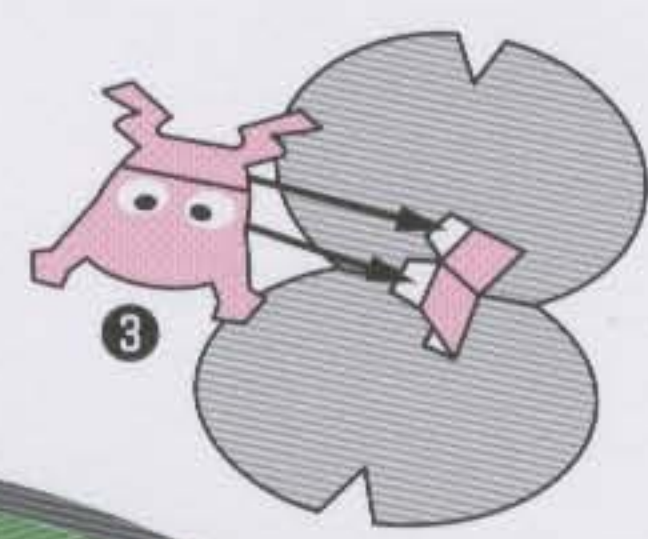
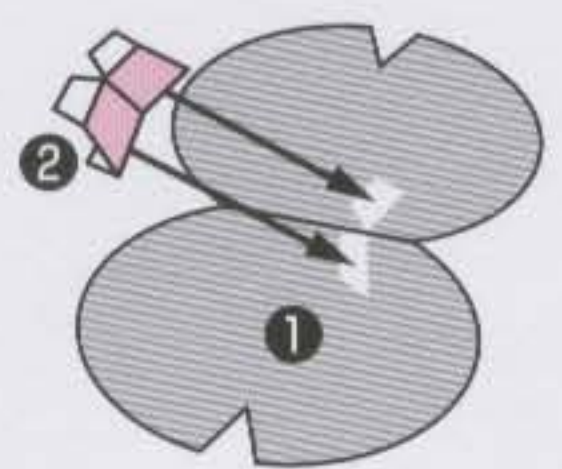

**HOW TO PLAY**

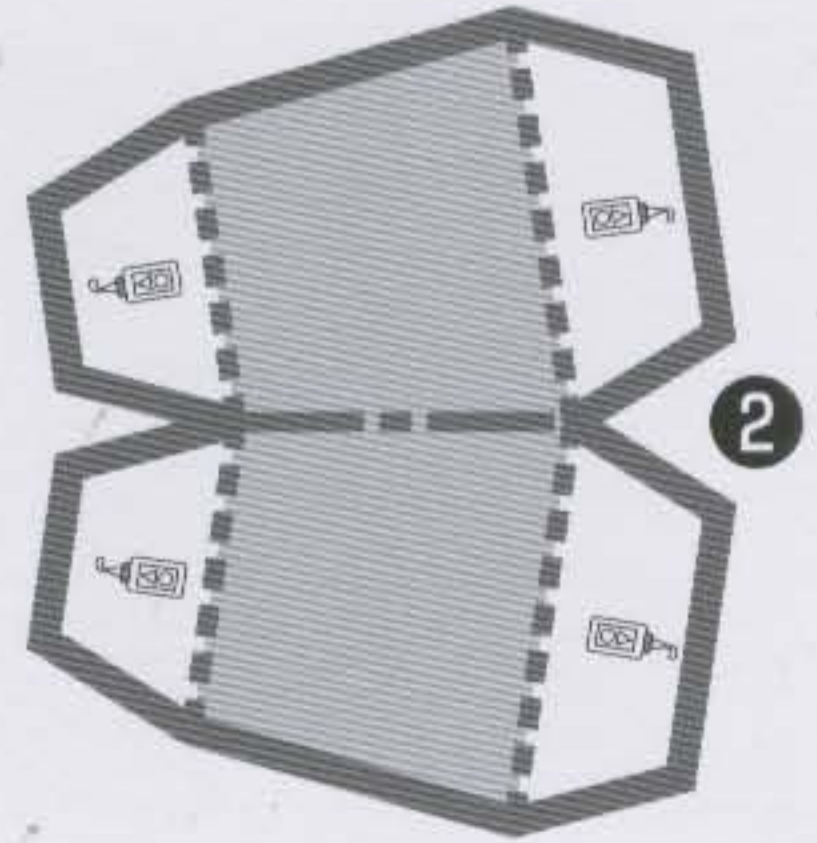
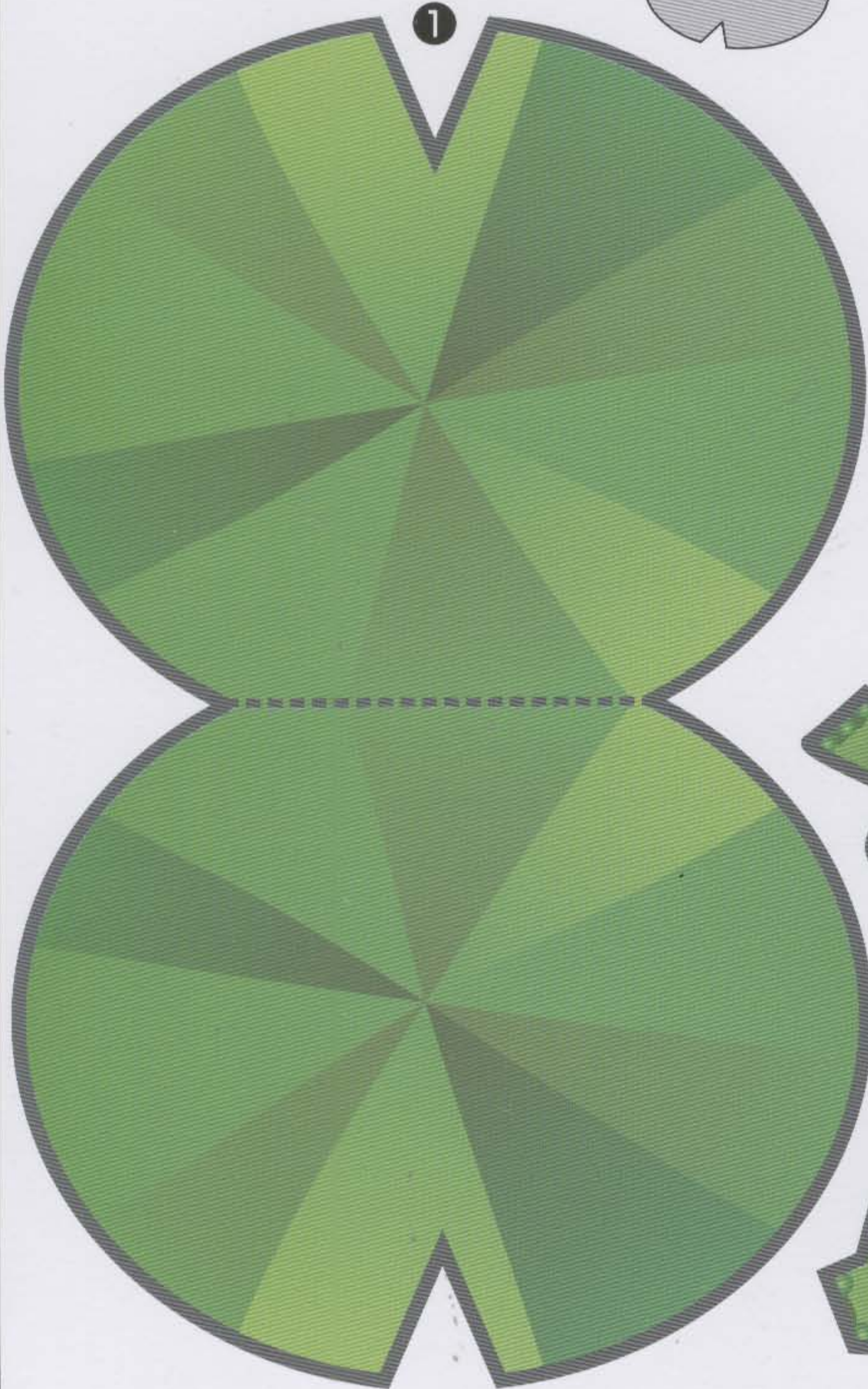

\*Parents, please cut along this line for your child.

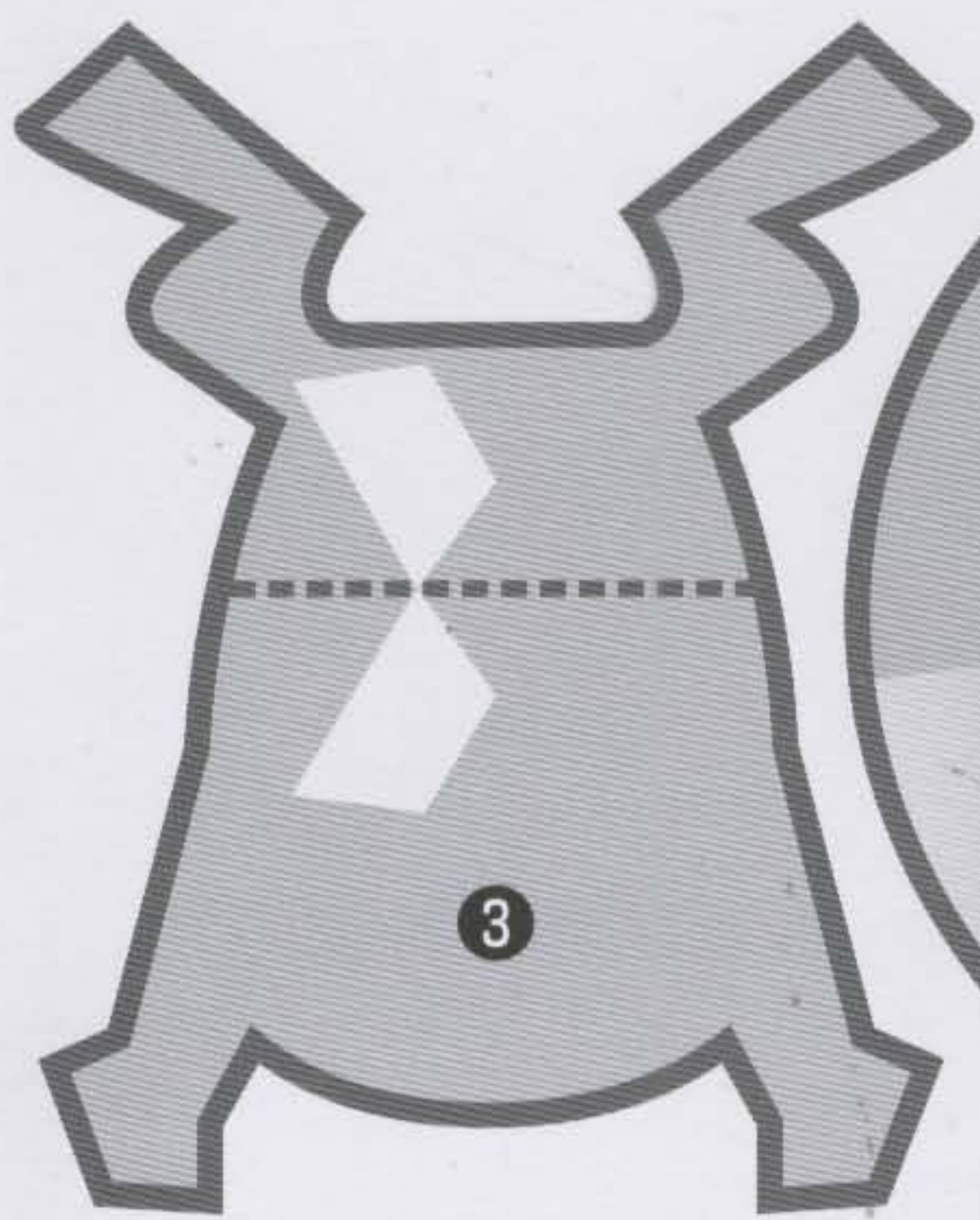
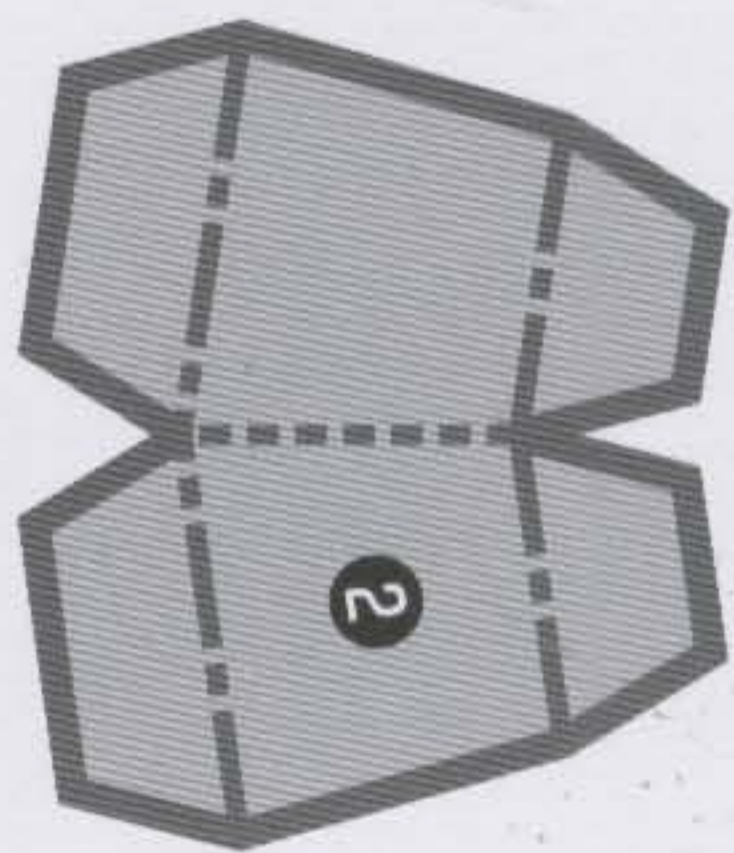
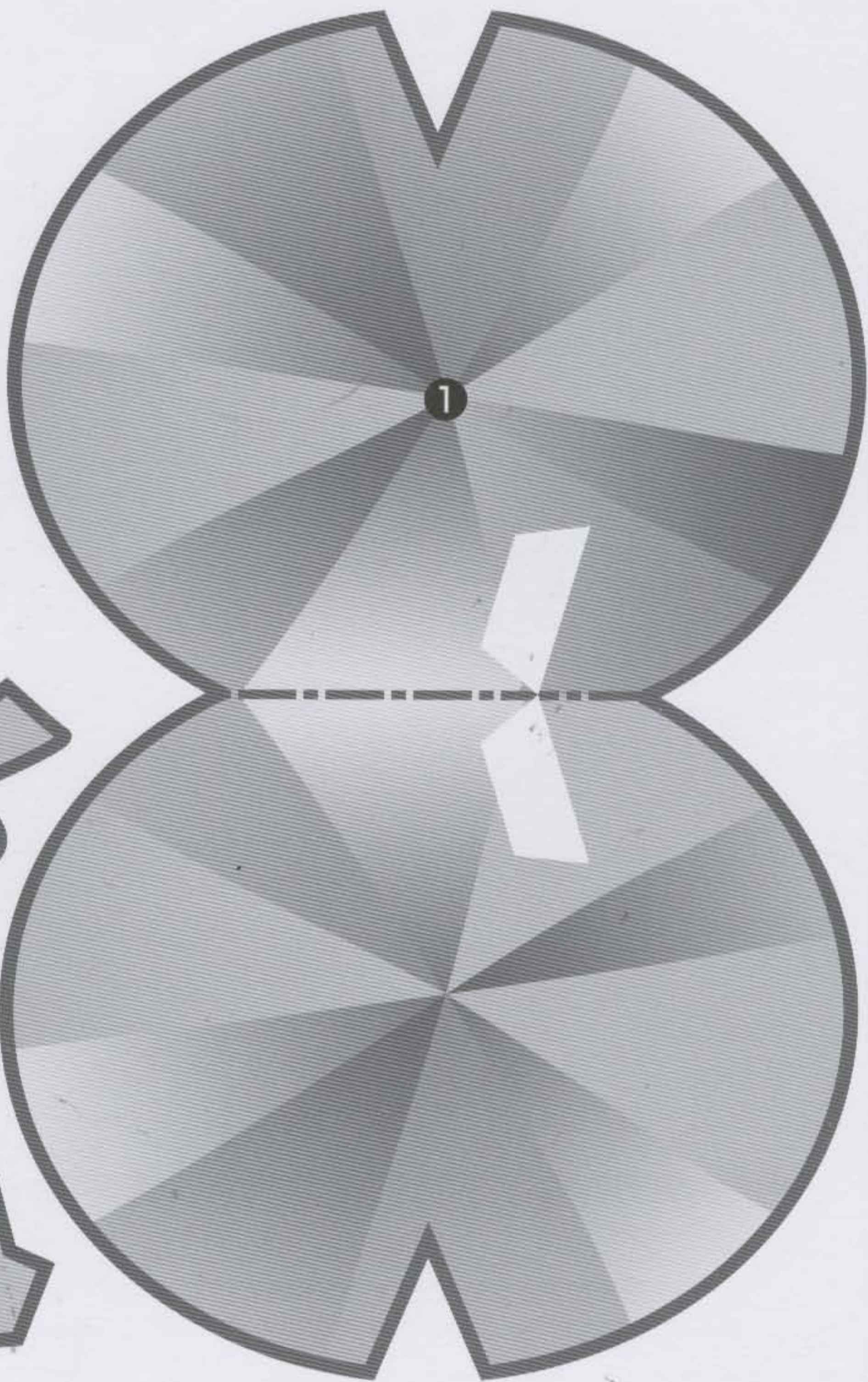

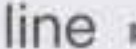

1. Cut along the thick lines .

2. Fold **1** downwards along the dotted line . Curl the torso part and paste the edges.

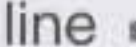
3. Fold **2** downwards along the dotted line . Paste **2**, **3**, and **4** onto **1** as shown below.

DONE!

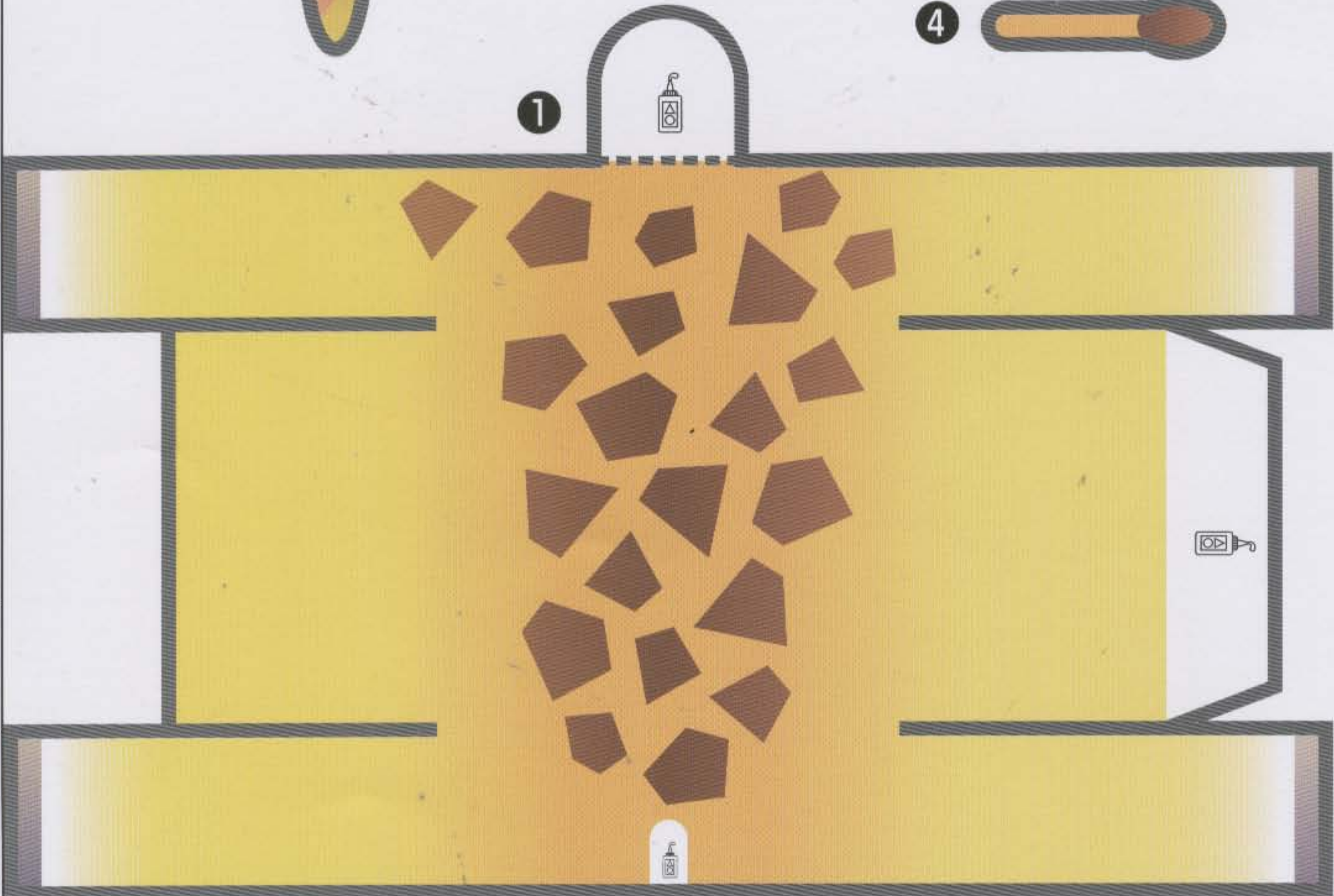
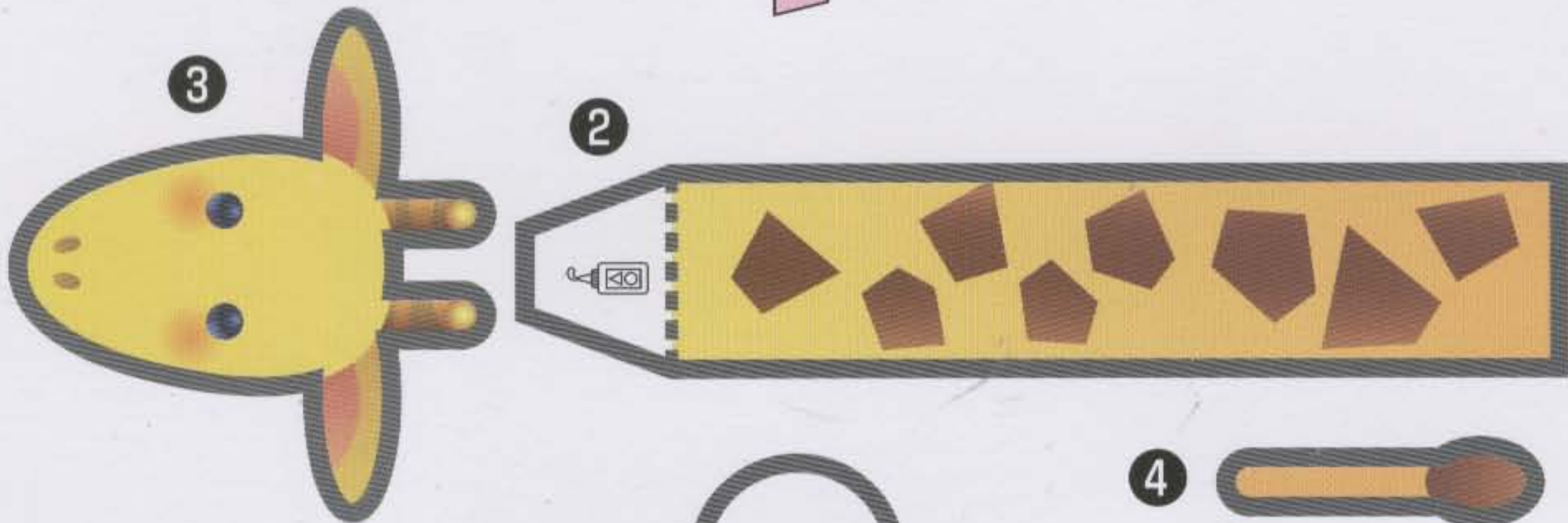
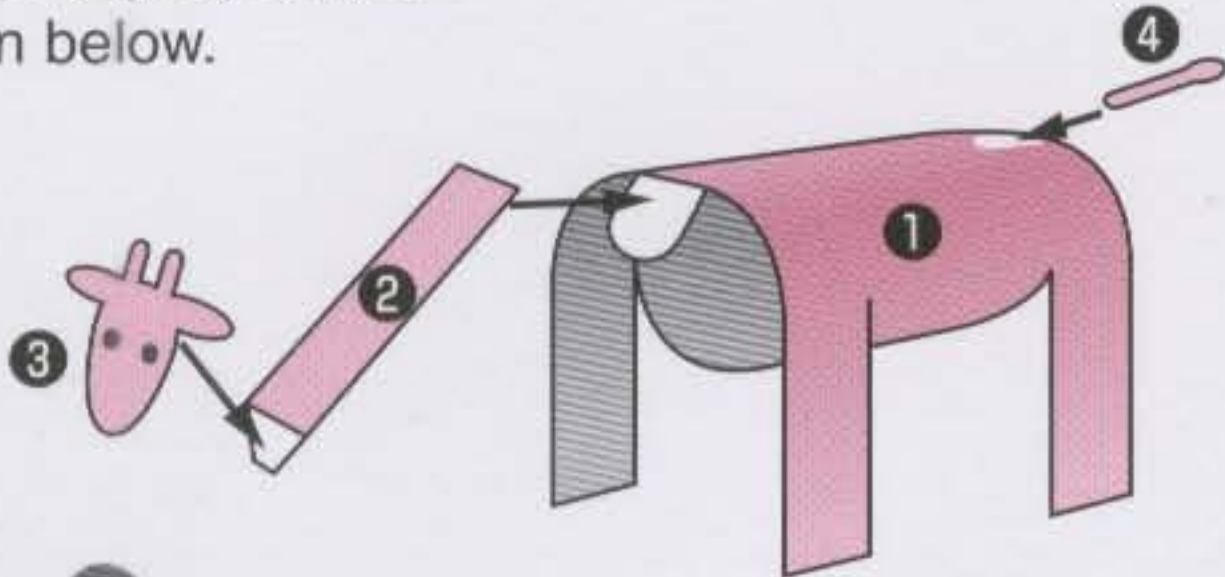
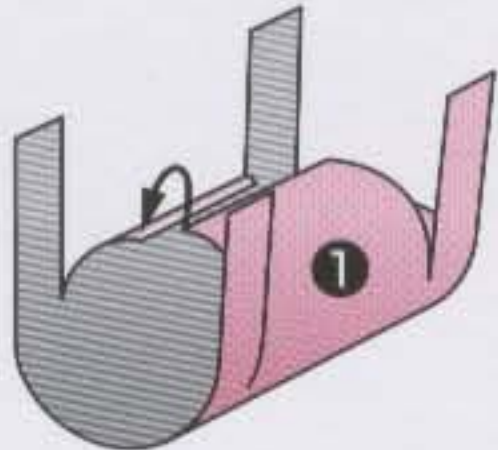
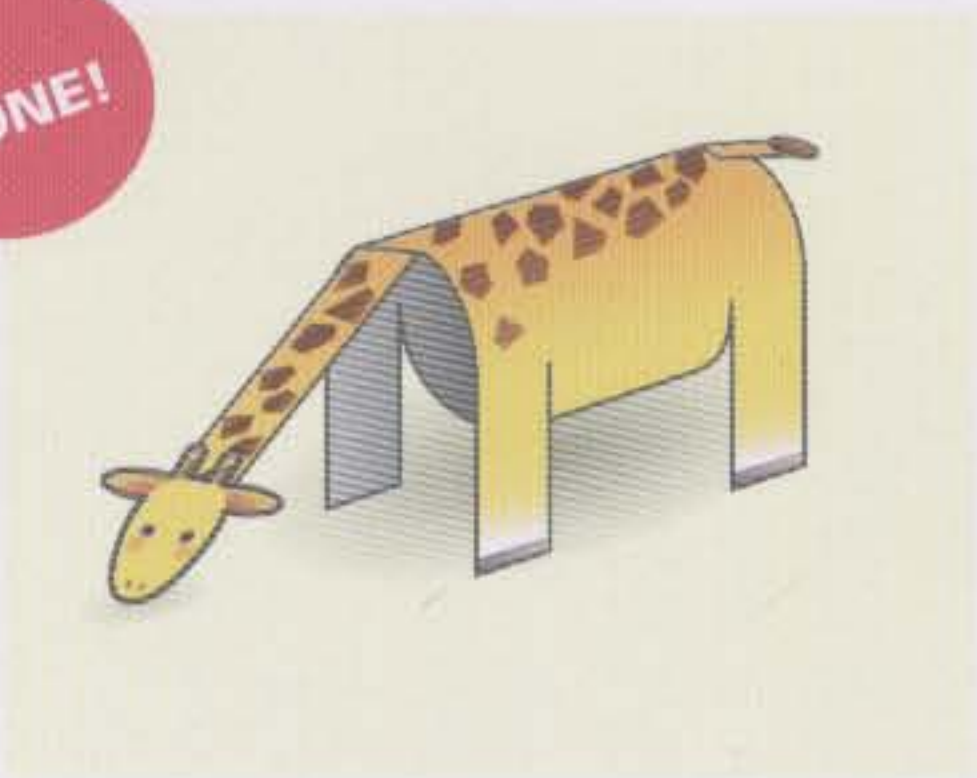

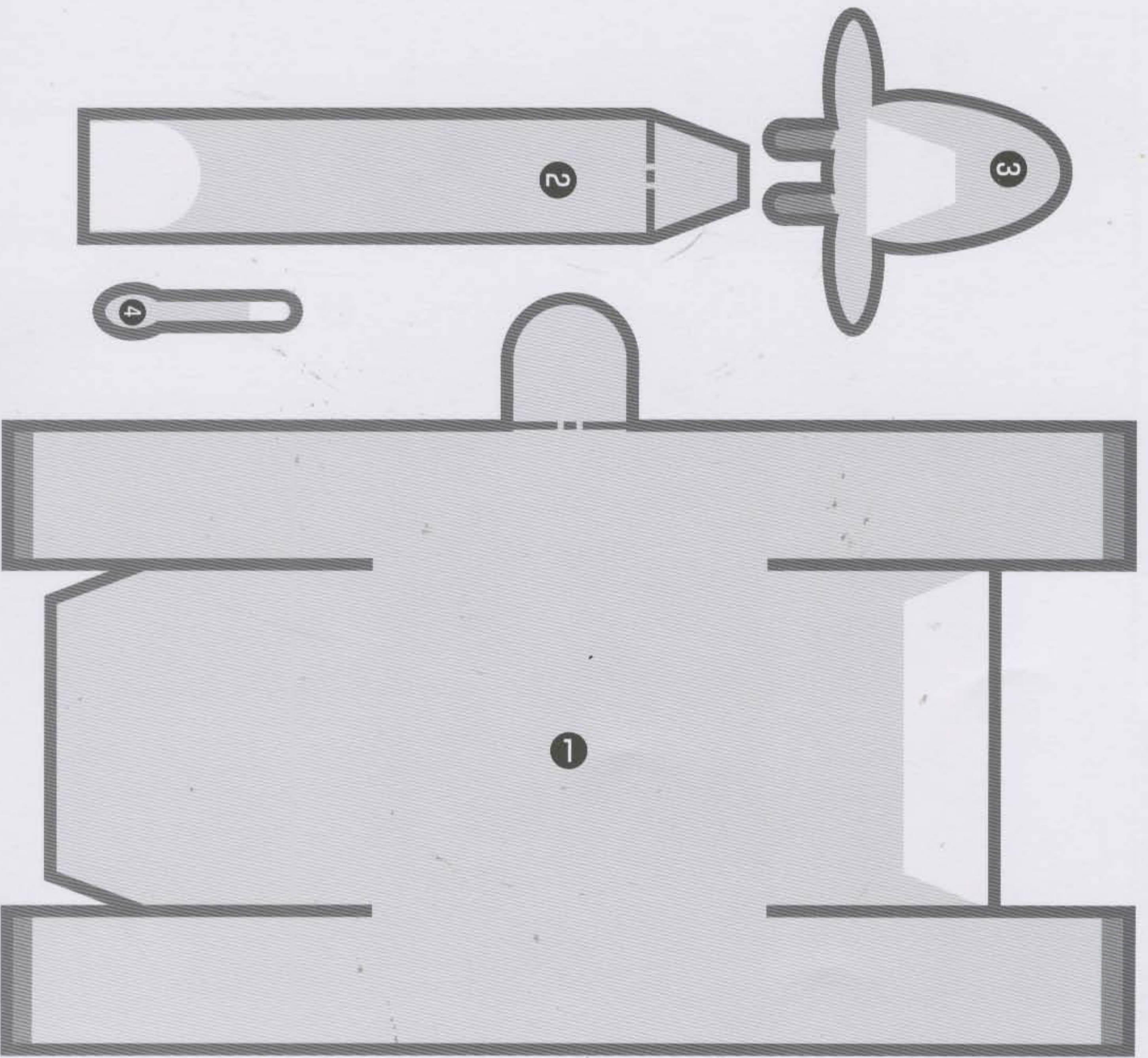

## Elephant

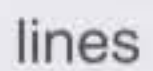
1. Cut along the thick lines .
2. Fold ① downwards along the dotted lines . Curl the torso part and paste the edges.
3. Paste ②, ③, ④, and ⑤ onto ①.

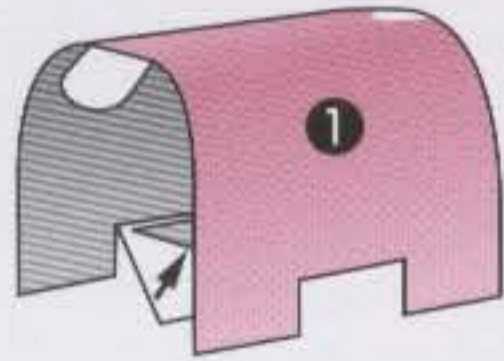

**DONE!**

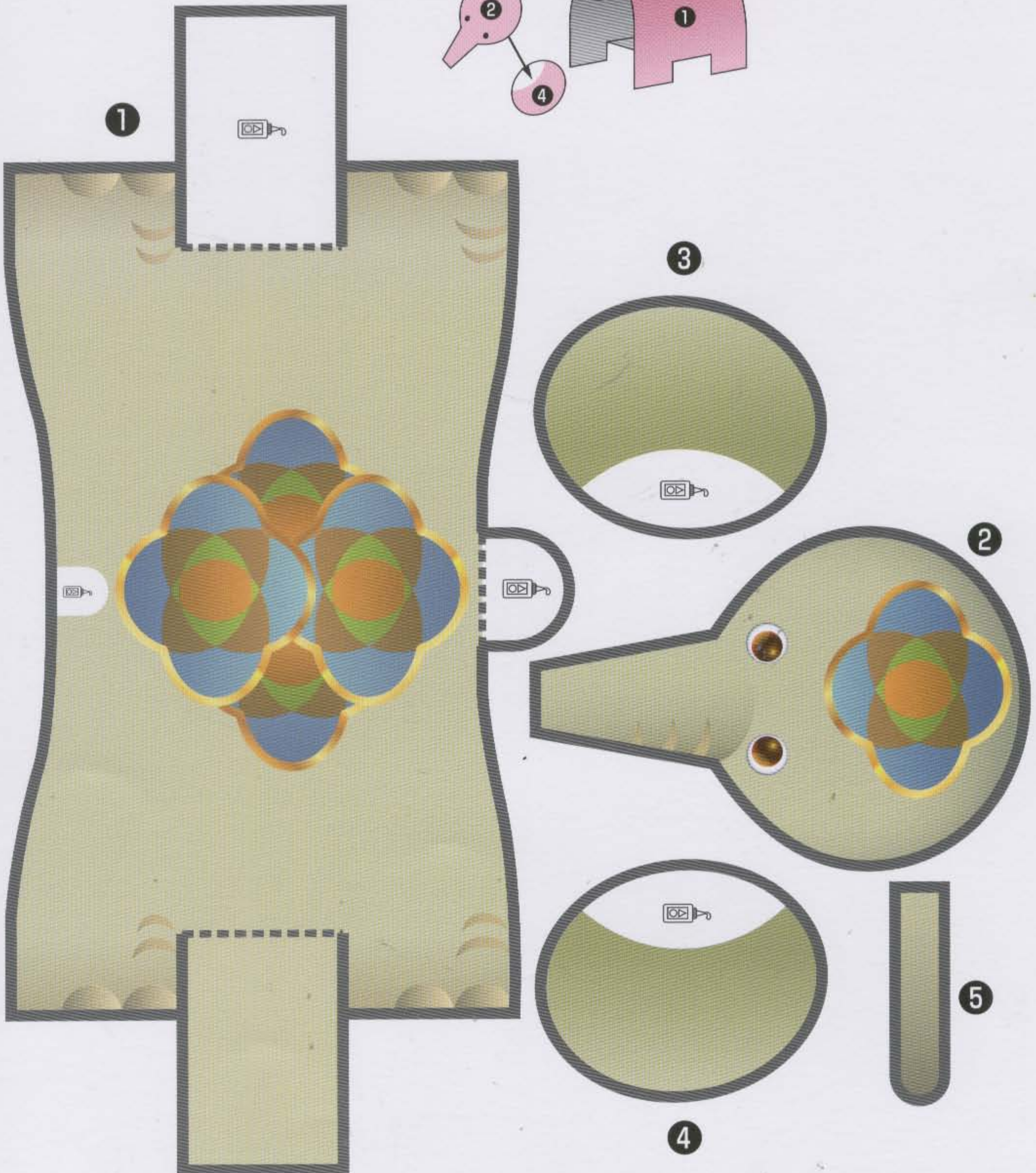
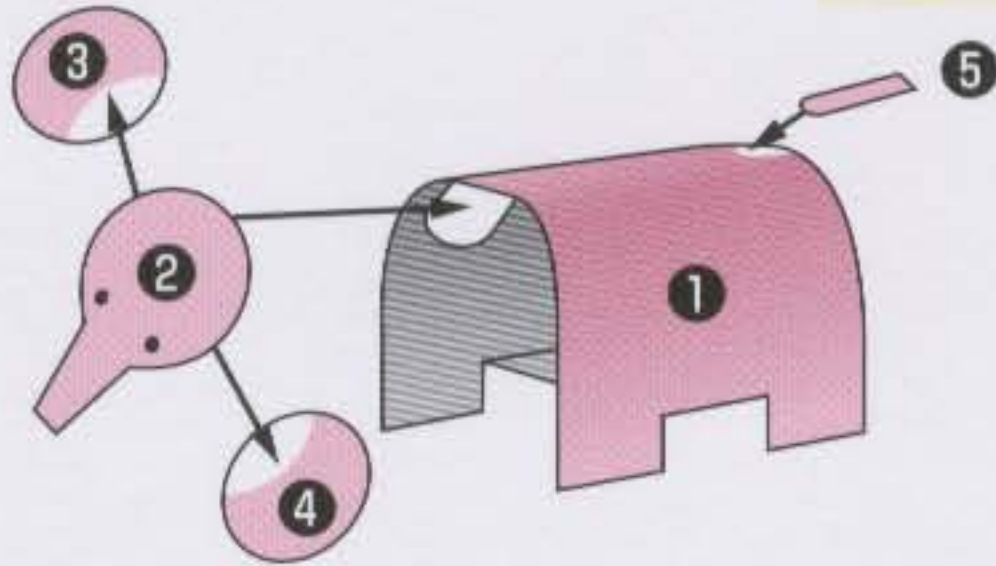

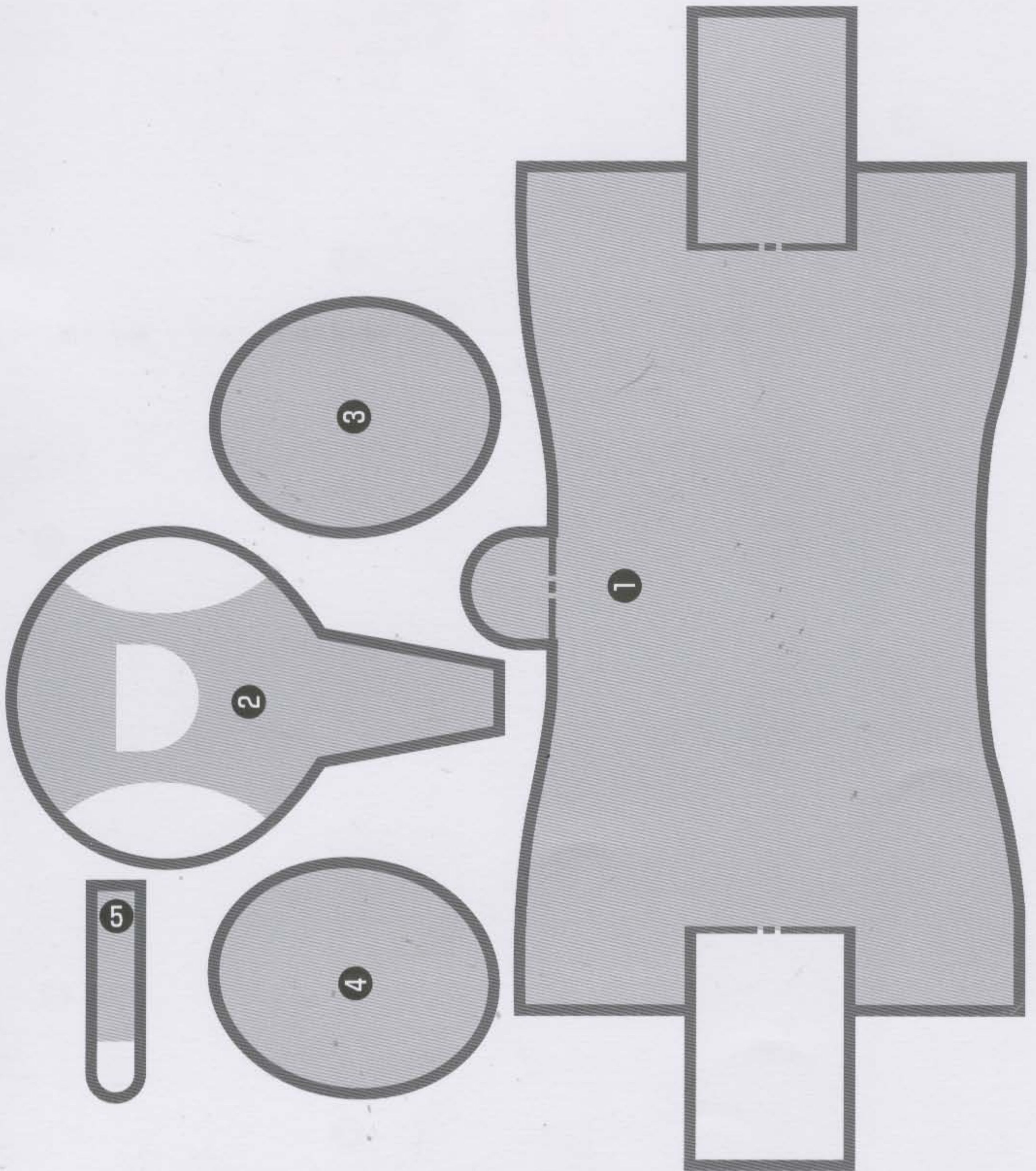

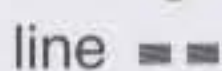

DONE!

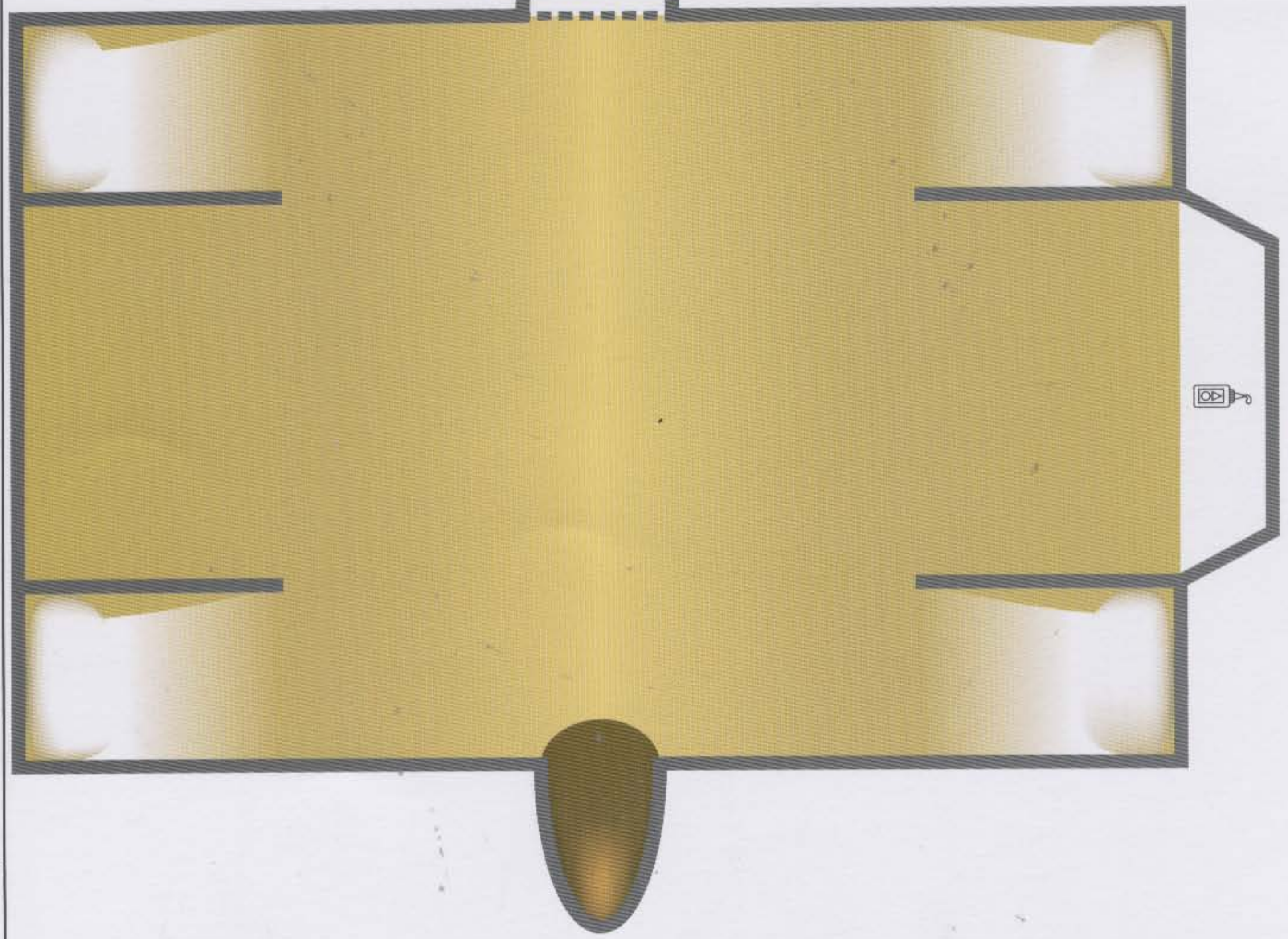
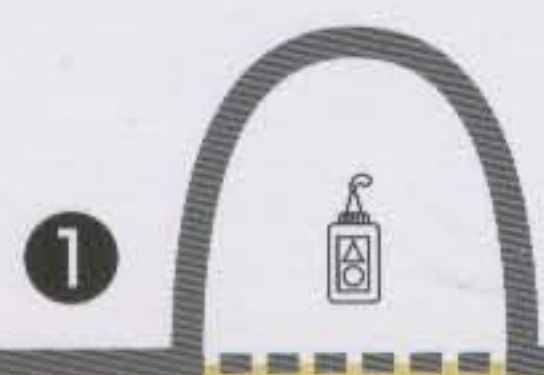
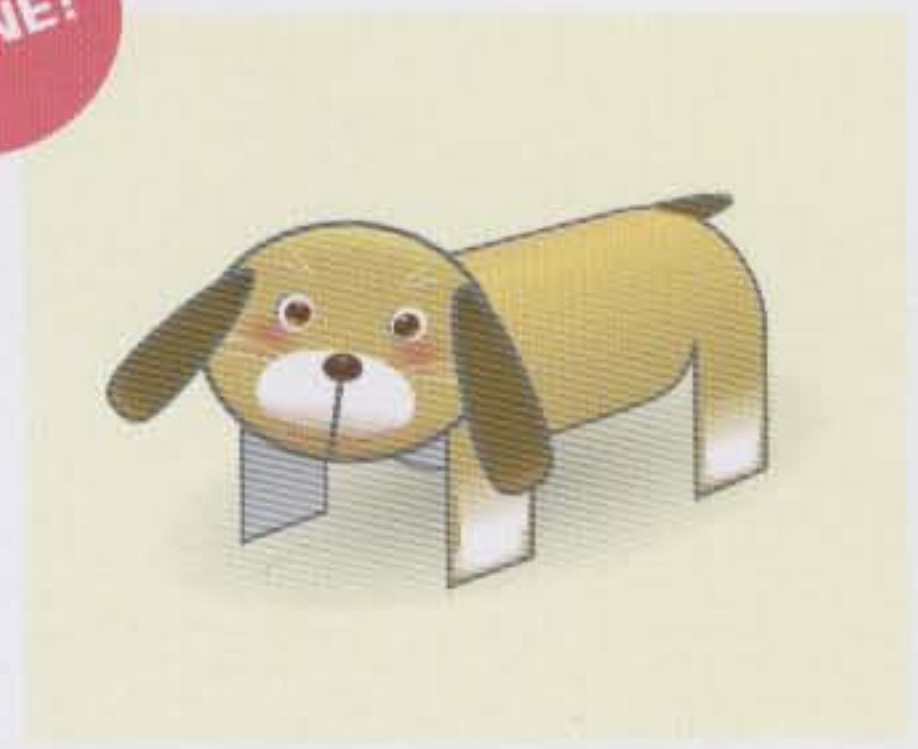
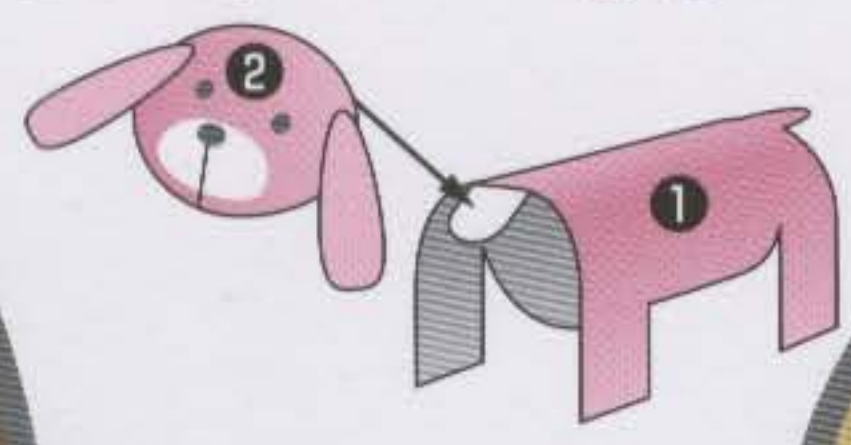
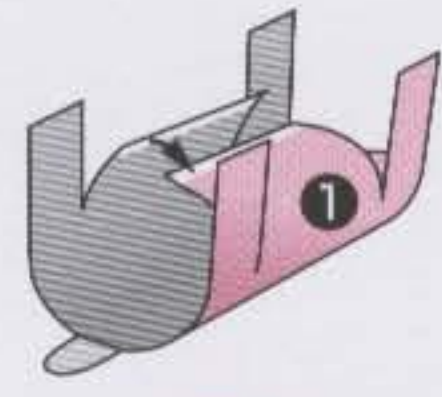
1. Cut along the thick lines .
2. Fold ① downwards along the dotted line . Curl the torso part and paste the edges.
3. Paste the tab of ② to the back of the adjacent edge to make a slight cone shape. Paste ③ onto ②.
4. Paste ② onto ①.

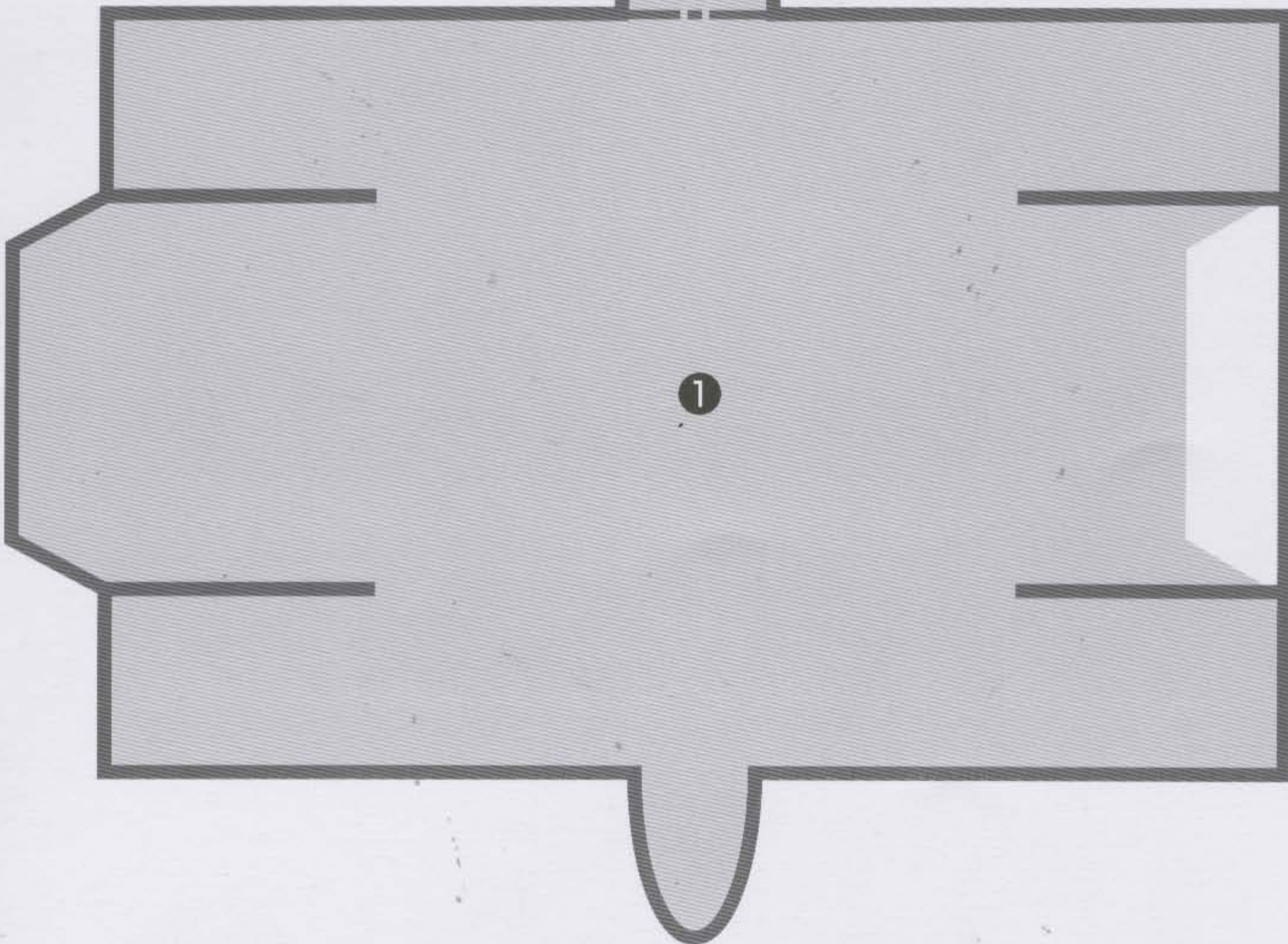
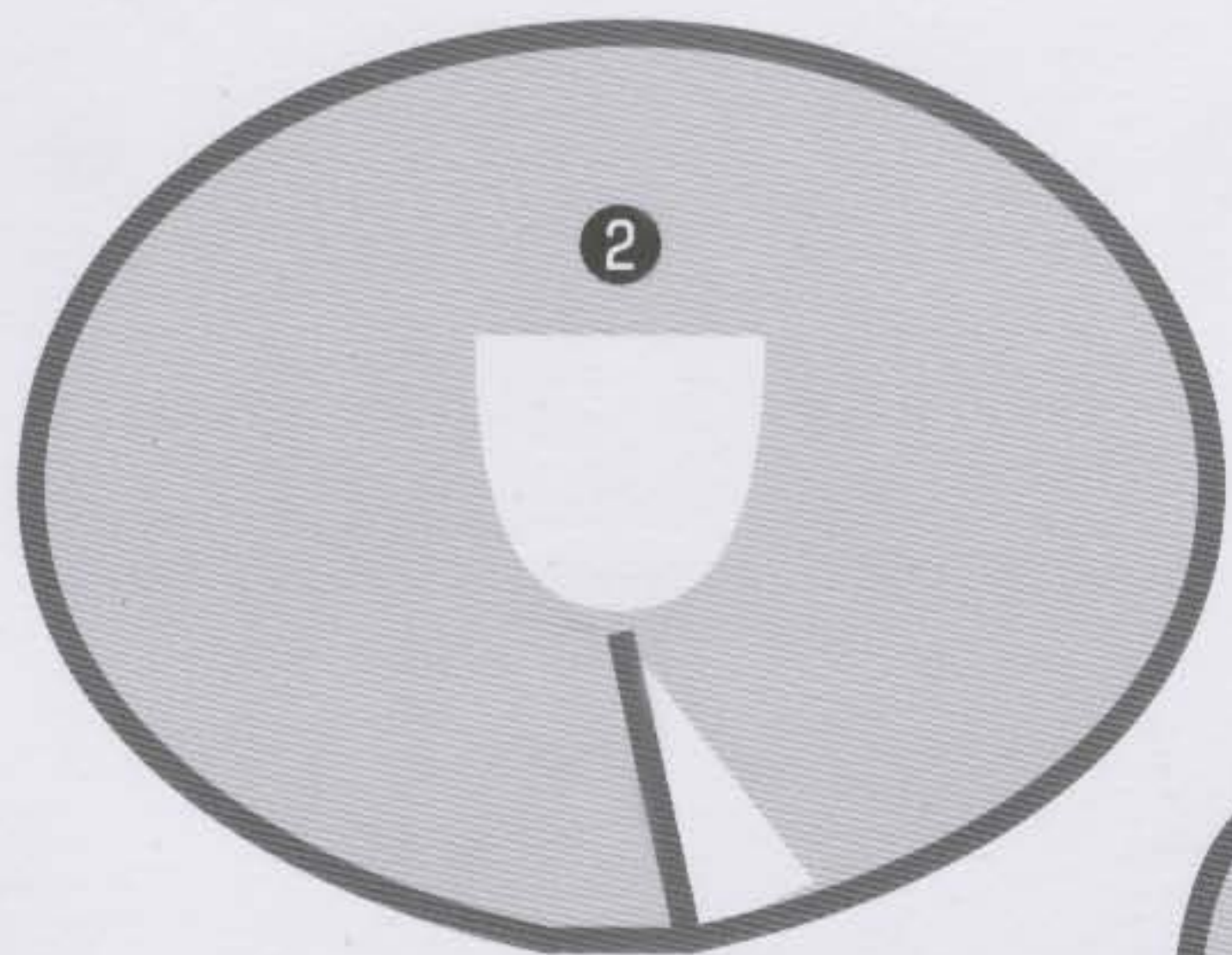

\*Parents, please cut along this line for your child.



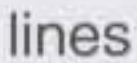

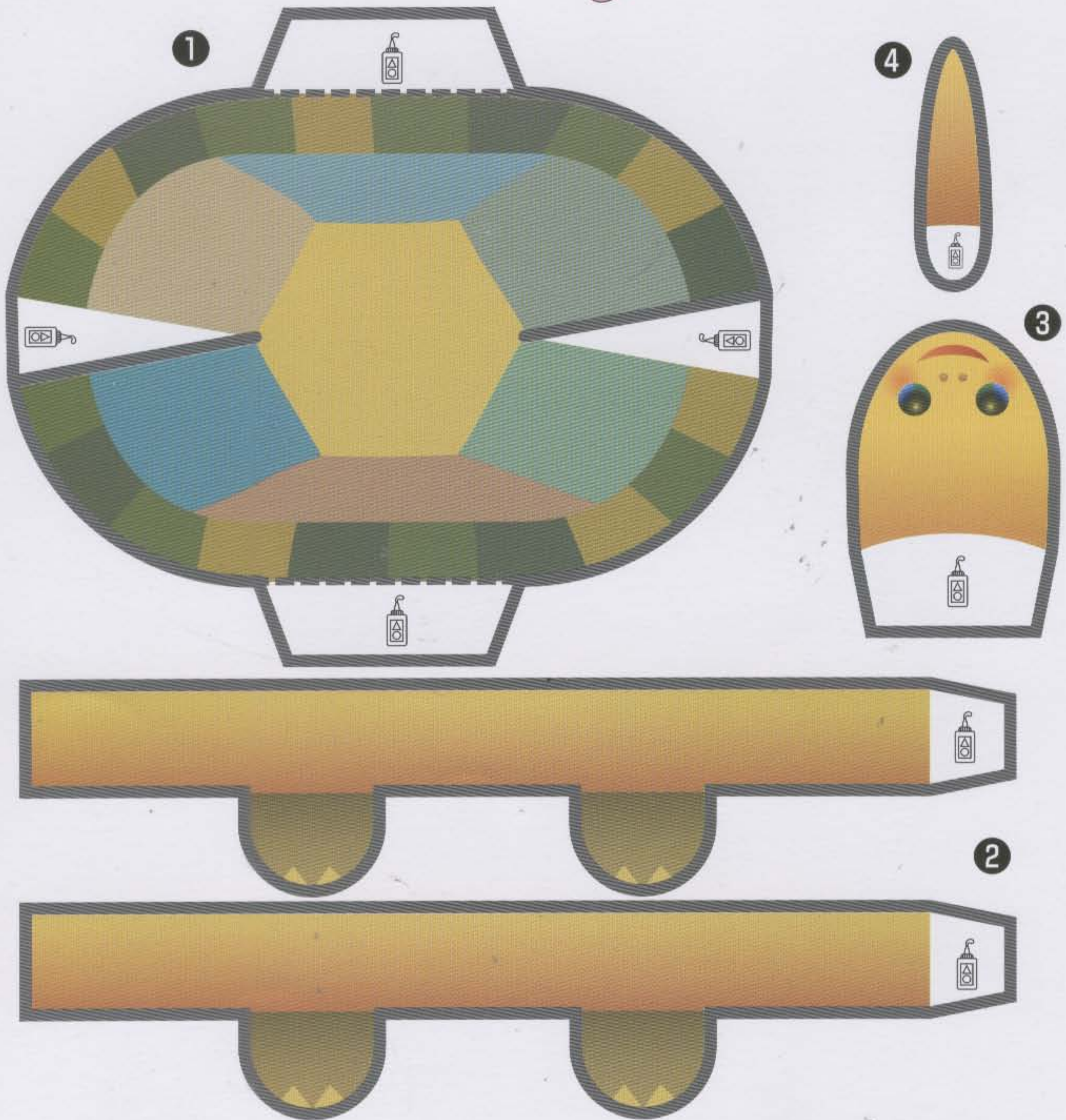
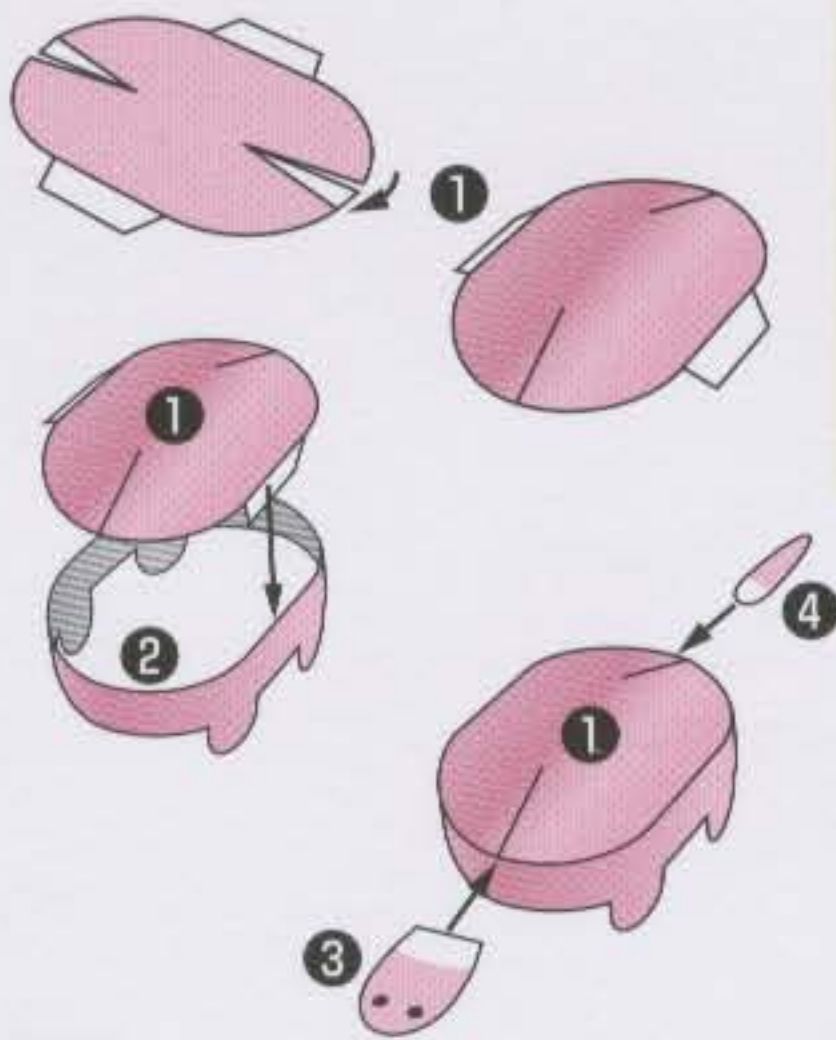
1. Cut along the thick lines .
2. Fold **1** downwards along the dotted lines . Paste each triangular tab of **1** onto the back of the adjacent edge.
3. Connect the two pieces of **2** together and attach them to **1**.
4. Attach **3** and **4** to **1** as shown on the right.

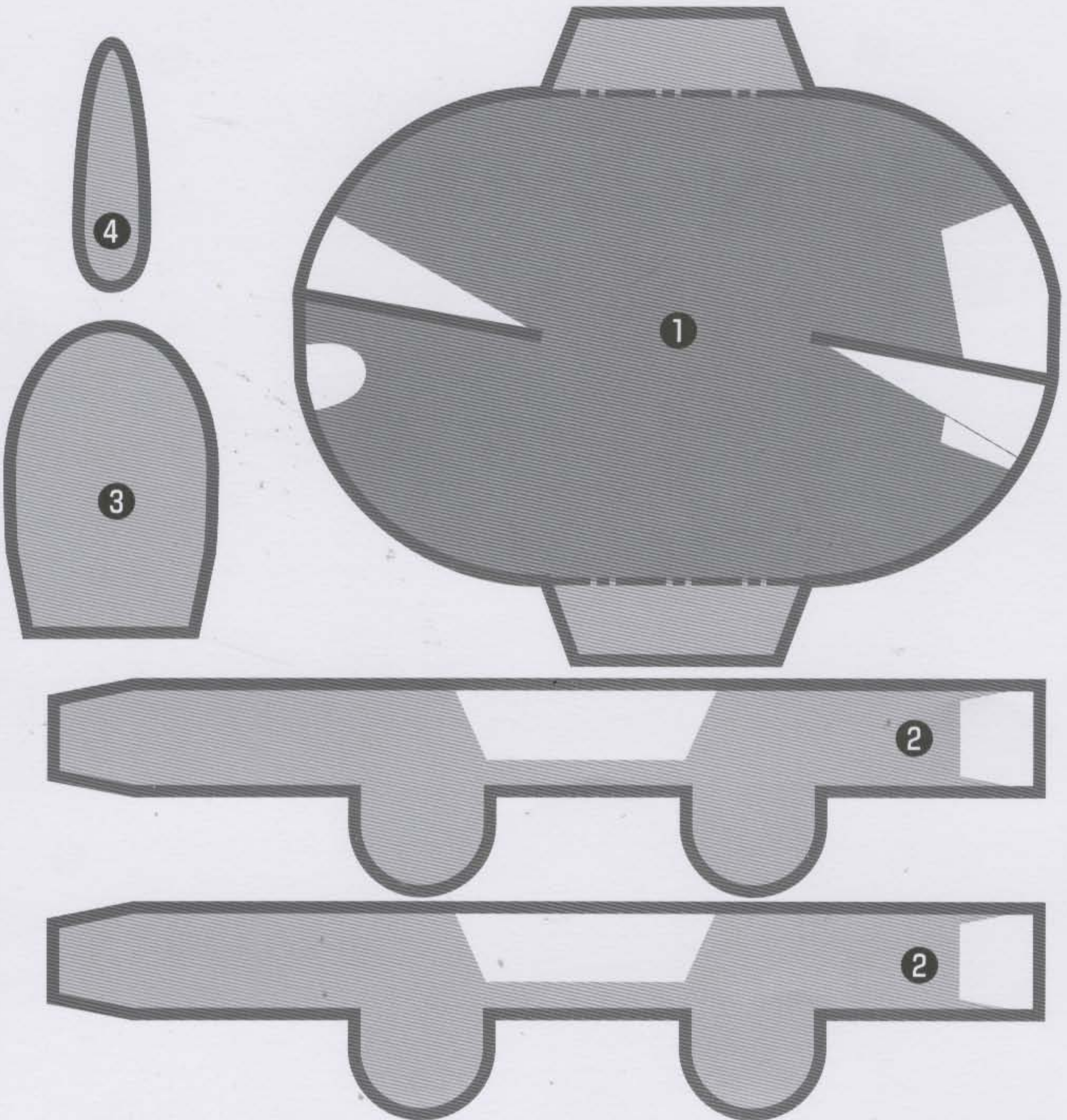



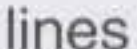
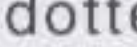

## Alligator

1. Cut along the thick lines .
2. Fold ① downwards along the dotted lines . Curl the torso part and paste the edges.
3. Paste ② onto the sides of ①.
4. Fold ③ and ⑤ downwards along the dotted lines  and fold ④ upwards along the dashed line . Attach them to ① as shown on the right.

